

# Sarvaš - neolitičko i eneolitičko naselje

---

**Balen, Jacqueline**

**Authored book / Autorska knjiga**

*Publication status / Verzija rada:* **Published version / Objavljena verzija rada (izdavačev PDF)**

*Publication year / Godina izdavanja:* **2005**

*Permanent link / Trajna poveznica:* <https://um.nsk.hr/um:nbn:hr:300:200642>

*Rights / Prava:* [In copyright](#)/[Zaštićeno autorskim pravom.](#)

*Download date / Datum preuzimanja:* **2024-09-19**



*Repository / Repozitorij:*

[AMZdepo - Repository of the Archaeological Museum in Zagreb](#)



*Jacqueline Balen*

***Sarvaš – neolitičko i eneolitičko naselje***

**Musei Archaeologici Zagrabienensis  
Catalogi et Monographiae**  
Katalozi i monografije  
Arheološkoga muzeja u Zagrebu  
Svezak II

**Jacqueline Balen**  
Sarvaš – neolitičko i eneolitičko naselje

**Nakladnik:**  
Arheološki muzej u Zagrebu

**Za nakladnika:**  
Ante Rendić-Miočević

**Urednik:**  
Vesna Herak

**Recenzenti:**  
Aleksandar Durman  
Tihomila Težak-Gregl

**Lektura:**  
Ana Diklić

**Prijevod na engleski:**  
Agnes Milovan

**Crteži:**  
Miljenka Galić

**Fotografije:**  
Filip Beusan  
Ivan Marović (sl. 2–14)

**Oblikovanje:**  
Krunoslav Vlahović  
Darko Gunjević

**Priprema:**  
LASERplus d.o.o.

**Tisak:**  
Denona d.o.o.

**Naklada 500 primjeraka**

**Musei Archaeologici Zagrabienensis  
Catalogi et Monographiae**  
Catalogues and monographs of  
the Archaeological Museum in Zagreb  
Volume II

**Jacqueline Balen**  
Sarvaš – Neolithic and Eneolithic settlement

**Publisher:**  
Archaeological Museum in Zagreb

**For the publisher:**  
Ante Rendić-Miočević

**Editor:**  
Vesna Herak

**Recension:**  
Aleksandar Durman  
Tihomila Težak-Gregl

**Proof reading:**  
Ana Diklić

**English translation:**  
Agnes Milovan

**Drawings:**  
Miljenka Galić

**Photographs:**  
Filip Beusan  
Ivan Marović (sl. 2-14)

**Graphic design:**  
Krunoslav Vlahović  
Darko Gunjević

**Layout:**  
LASERplus d.o.o.

**Printed by:**  
Denona d.o.o.

**Printed in 500 copies**

CIP - Katalogizacija u publikaciji  
Nacionalna i sveučilišna knjižnica – Zagreb

UDK 903.4(497.5 Sarvaš)

BALEN, Jacqueline  
Sarvaš – neolitičko i eneolitičko naselje / Jacqueline Balen ; <prijevod na engleski Agnes Milovan ; crteži Miljenka Galić ; fotografije Filip Beusan, Ivan Marović>. – Zagreb : Arheološki muzej, 2006.  
– (Katalozi i monografije Arheološkog muzeja u Zagrebu ; sv. 2 = Musei Archaeologici Zagrabienensis catalogi et monographiae ; <2> = Catalogues and monographs of the Archaeological Museum in Zagreb ; vol. 2)

Tekst usporedo na hrv. i eng. jeziku. – Bibliografija.

ISBN 953-6789-27-2

I. Arheološki muzej. Pretpovijesna zbirka (Zagreb) – – Katalog  
II. Arheološki nalazi – – Sarvaš (Osijek)  
III. Sarvaš (Osijek) – – Arheološka istraživanja

300926048

Jacqueline Balen

# SARVAŠ

neolitičko i  
eneolitičko  
naselje



## Sadržaj

Predgovor / Preface .....	7
Uvod / Introduction .....	11
Povijest i stanje istraživanja nalazišta / Historic overview and exploration status of the site .....	15
Nalazi u fondusu Arheološkoga muzeja u Zagrebu / Finds in the holdings of the Archaeological Museum in Zagreb .....	23
Neolitik / The Neolithic .....	25
Starčevačka kultura / The Starčevo culture .....	25
Sopotska kultura / The Sopot culture .....	28
Eneolitik / The Eneolithic .....	30
Badenska kultura / The Baden culture .....	30
Kostolačka kultura / The Kostolac culture .....	34
Vučedolska kultura / The Vučedol culture .....	38
Ostali nalazi / Remaining finds .....	56
Zaključak / Conclusion .....	59
APPENDIX – English translation of the footnotes .....	62
Katalog / Catalogue .....	65
Popis literature / Bibliography .....	92
Table / Plates .....	96



## Predgovor

U Predgovoru prvome svesku novopokrenute serije monografsko-kataloških izdanja s naslovom *Musei Archaeologici Zagrabensis Catalogi et Monographiae* (Katalozi i monografije Arheološkog muzeja u Zagrebu) pokušali smo obrazložiti motive koji su potaknuli pokretanje takve edicije. Izrazili smo tada očekivanja da će takvom serijom muzejskih izdanja biti popunjena praznina za koju je očito da se ne može nadomjestiti publiciranjem u postojećim izdanjima, a pogotovo ne u svescima muzejskoga godišnjaka. Trebalo je, dakle, osigurati uvjete za pokretanje edicije kojoj bi cilj bio objavljivanje građe iz muzejskoga fundusa, odnosno većih koherentnih skupina predmeta iz različitih muzejskih zbirki, što podrazumijeva i odgovarajuću katalošku obradbu spomeničkoga materijala. Tom edicijom željeli smo ujedno omogućiti zainteresiranim autorima da, uz samo najnužnije promjene i dopune, objave svoje magistarske radove ili doktorske disertacije, poglavito one povezane s fundusom pojedinih muzejskih zbirki, ne postavljajući pritom ograničenja koja su u drugačijim okolnostima ne samo potrebna nego nerijetko i neizbježna. Smatrali smo također da bi se serijom takvih izdanja, sukladno aktualnim potrebama i preporukama, mogao djelomice nadoknaditi zaostatak u objavljivanju muzejske građe. Pojedini svesci trebali bi se pojavljivati u ritmu koji će u znatnoj mjeri ovisiti o aktualnim financijskim mogućnostima, ali valja očekivati i da će to podjednako ovisiti i o ažurnosti autora te o odabranim ili obrađenim temama. U svemu tome trebat će voditi računa o činjenici da je prioritet Muzeja u nakladničkoj djelatnosti uvijek bio, a tako bi trebalo ostati i u budućnosti, redovito izlaženje muzejskoga znanstveno-stručnoga glasila Vjesnika Arheološkog muzeja u Zagrebu, časopisa koji ima tradiciju izlaženja od gotovo 140 godina.

Da naša optimistička očekivanja glede novopokrenute serije nisu iznevjerena pokazuje odjek u stručnoj i znanstvenoj javnosti objavljenog sveska s naslovom *Militaria Sisciensia* – Nalazi rimske vojne opreme iz Siska u fundusu Arheološkog muzeja u Zagrebu koji autorski potpisuje Ivan Radman-Livaja. Zanimanje za navedeno izdanje, i u nas i u inozemstvu, premašilo je naša očekivanja, što je svakako dobar razlog za nadu u uspješan nastavak započete serije.

Temu drugoga sveska već smo, doduše samo uzgredno, najavili u Predgovoru prvome svesku, kao napomenu da je nakon objavljivanja vojne opreme iz Siska na redu objava nalaza iz poznatoga pretpovijesnog nalazišta Sarvaš. Pukim

## Preface

In the preface to the first volume of the newly launched series of monographs and catalogue editions entitled *Musei Archaeologici Zagrabensis Catalogi et Monographiae* (Catalogues and monographs of the Archaeological Museum in Zagreb) we tried to explain the motives that triggered the launching of such an edition. At that time we expressed our expectations according to which such a series of museum issues would fill the gap that could clearly not be bridged by publishing in the existing editions, and above all not by publishing in the volumes of the Museum's annual. It was therefore necessary to launch an edition whose aim would be to publish the material from the Museum's holdings i.e. of larger and coherent groups of items from different Museum collections, which implies the existence of a corresponding catalogue analysis of the material. With this edition we also wished to enable interested authors to publish their Master's theses or PhD dissertations, particularly those works related to the holdings of the single Museum collections, and have therefore put no limits that under different circumstances would have been not only necessary but often unavoidable. We also were of the opinion that with a series of editions, in line with the current needs and recommendations, we could partly reduce the backlog in the publishing of Museum materials. Single volumes should become available with a rhythm that will significantly depend on the current financial possibilities, but it will as much depend on the up-datedness of authors as well as on the selected or analysed topics. What must be considered in this context, is the fact that the priority of the Museum in the editing activity has always been, and it should stay like this in the future, the regular issuance of the museum scientific-professional annual Vjesnik Arheološkog muzeja u Zagrebu (the Journal of the Archaeological Museum in Zagreb), a journal that upholds 140 years of tradition.

That our optimistic expectations concerning the newly launched series have been met is proved by the response among the professional and scientific public of the published volume entitled *Militaria Sisciensia* – Finds of the Roman military equipment in Sisak in the holdings of the Archaeological Museum in Zagreb written by Ivan Radman-Livaja. The interest in the mentioned edition, both in our country and abroad, exceeded our expectations, which surely is a good reason for hoping in the successful continuation of the launched series.

The topics of the second volume have already been announced – the preface to the first volume, as a remark that after pub-



slučajem autorica aktualnoga sveska posvećena Sarvašu bila je urednicom prethodnoga sveska. Riječ je o Jacqueline Balen, kustosici u Pretpovijesnoj zbirci Muzeja, koja je obradila 302 predmeta sa sarvaškoga nalazišta, od ukupno 527 pohranjenih u toj muzejskoj zbirci. Navedeni nalazi s toga lokaliteta pretežito su neolitičkoga i eneolitičkoga podrijetla, premda ih u manjem broju ima i iz kasnijih pretpovijesnih razdoblja. Ovom prigodom obradila je i sve relevantne aspekte koji se odnose na taj lokalitet. Teško je ne primijetiti da autorica novoga sveska pripada približno istoj generaciji muzejskih kustosa kao i autor prethodnoga sveska. Sve upućuje na to da je riječ o generaciji visoke razine ambicioznosti, a, što je još važnije, i uspješnosti, pa možemo očekivati da će i najnovije izdanje iz novopokrenute serije, a i ona koja će tek uslijediti, imati priželjkivanu budućnost. Ovom bismo prigodom najavili sljedeće sveske. Po svemu sudeći prvi u nizu trebao bi biti posvećen jednom dijelu iznimno bogate zbirke grčkih vaza, a u nastavku bismo se mogli nadati i objavljivanju kataloga Egipatske zbirke, jedinstvene zbirke takva sadržaja na ovdašnjim prostorima.

Naslov aktualnoga sveska Kataloga i monografija zagrebačkog Arheološkog muzeja **Sarvaš – neolitičko i eneolitičko naselje** otkriva da mu je tema lokalitet Sarvaš, a jasno naznačava i njegovu stratigrafsku višeslojnost. Široj javnosti vjerojatno je manje poznato da taj lokalitet, zajedno s drugim poznatim podunavskim pretpovijesnim nalazištima, primjerice glasovitim Vučedolom, zatim Bapskom ili Vinkovcima, pripada skupini u literaturi najčešće spominjanih lokaliteta u hrvatskom Podunavlju. Autorica također donosi i kronološki prikaz arheoloških istraživanja na sarvaškome telu. Prema njezinim navodima od osobite su važnosti bila iskopavanja Sarvaša koja je obavljao poznati njemački arheolog R. R. Schmidt 1942-1943. godine. On je ujedno vodio i istraživanja na Vučedolu, pa je i zaslužan za otkriće vjerojatno najpoznatijega našeg pretpovijesnog nalaza, znamenite vučedolske »golubice«! Autorica otkriva i neke zanimljive, takoreći bizarne podatke, koji se, primjerice, odnose na itinerar kojim je putovala otkrivena građa, iako ju je Schmidt, čini se, prvotno bio namijenio jednom od osječkih muzeja. Zbog ondašnjih ratnih okolnosti, umjesto u Osijek, prikupljena je građa iz Sarvaša bila usmjerena prema Njemačkoj. To je međutim bilo spriječeno, pa je materijal bio najprije vraćen u Beograd, a potom poslan u Zagreb, nakon čega je jedan dio pripao zagrebačkom Arheološkomu muzeju, a drugi dio Muzeju Slavonije u Osijeku! Velika je šteta što je u ratnom vihoru bila uništena gotovo cjelokupna relevantna dokumentacija, a čini se i Schmidtov već pripremljen rukopis o nalazima i nalazištu. U takvim okolnostima materijal je u znanstvenom pogledu svakako izgubio na značenju, pa stoga nikad i nije bio cjelovito objavljen. Upravo zato kataloška obradba nalaza pohranjenih u zagrebačkome Muzeju, i onih koji su dobiveni Schmidtovim istraživanjima, i onih prethodno prikupljenih kupnjom ili poklonjenih (prvi takvi nalazi pristigli su u Muzej još na početku 1900. god.) pružit će mogućnost zainteresiranima da unatoč nedostatku stratigrafskih i drugih relevantnih podataka o okolnostima u kojima su predmeti nađeni, stručno obrađenu građu, velikim dijelom još neobjavljenju, mogu sagledati cjelovito. Na taj način bi ona, kako je autorica i sama naglasila, mogla poslužiti u daljnjim istraživanjima najranijih pretpovijesnih razdoblja na području istočne Slavonije i Srijema. U tom kontekstu

lishing the war equipment from Sisak it was the turn of the finds from the famous prehistoric finding site of Sarvaš. The author of the current volume which is dedicated to the Sarvaš is by chance the editor of the previous volume: Ms. Jacqueline Balen, the custodian of the Prehistoric Museum collection, has analysed 304 items of the overall 527 from the Sarvaš finding site that are stored in the Museum collection. The finds from this finding site are mainly of neolithic or eneolithic origin, although there are also items from later prehistoric periods but in smaller amounts. Ms. Balen has analysed also all relevant aspects that are related to this site. It is hard not to notice that the author of the new volume belongs approximately to the same generation of custodians as the author of the first volume does. Everything seems to indicate a generation characterized by a high degree of ambition and, more importantly, of success. We can therefore expect this new edition of the newly launched series and those that will follow, to have the coveted future. Hereby we would like to announce the topics of the next volumes. The first in the row should be devoted to part of an exceptionally rich collection of Greek vases, and in addition we could hope for publishing a catalogue of the Egyptian collection, a unique collection with such a content on hither territories.

The title of the current volume Catalogue and monograph of the Zagreb Archaeological Museum **Sarvaš – Neolithic and Eneolithic settlement** reveals that the topic and site is Sarvaš and clearly denotes its stratigraphically multi-layered nature. To the broader public it is probably less known that the site, together with other well known prehistoric finding sites from the Danubian region, as for example the famous Vučedol, Bapska or Vinkovci, belongs to the group of most frequently mentioned sites in the Croatian region of the Danube river. The author gives also a chronological overview of the archaeological excavations carried out at the Sarvaš tell. Of great importance were, according to the author's statements, the excavations of the Sarvaš carried out by the famous German archaeologist R. R. Schmidt in 1942 and 1943. He also conducted the excavations at Vučedol and is therefore meritorious of the revelation of our probably best known prehistorical find: the remarkable Vučedol dove. The author reveals also few very interesting, almost bizarre data concerning the itinerary according to which the revealed materials travelled, in spite of the fact that Schmidt apparently designated them for one of the Osijek museums. Due to the war environment instead of Osijek the gathered materials from Sarvaš were directed to Germany. This was however prevented to happen, so that the material was first returned to Belgrade and finally sent to Zagreb. One part of the materials was allocated to the Archaeological Museum in Zagreb and the other to the Osijek Museum of Slavonia. It is a pity that in the whirlwind of war almost all relevant documentation was destroyed including Schmidt's already prepared manuscript on the finds and the finding site.

Under such circumstances the material has certainly lost much importance from the scientific point of view and has therefore never been thoroughly published. That is why the catalogue analysis of the finds stored in the Zagreb Museum, of those received through Schmidt's research and those previously gathered by acquisitions or donations (the first finds reached the Museum at the beginning of 1900) will offer the possibility to see the professionally analysed material as a whole – regardless of the lack of stratigraphic and other relevant data about the

valja sagledavati značenje ovoga najnovijeg znanstvenog prinosa Jacqueline Balen, autorice koja se u dosadašnjem radu već iskazala kao plodan autor stručnih i znanstvenih priloga te kao voditelj ili suradnik u istraživanjima mnogih važnih arheoloških lokaliteta, a što je za Muzej također od velikoga značenja, i kao autor ili suautor niza zanimljivih muzejskih izložbenih projekata. Ova publikacija, kao i sve koje će, nadamo se, nastaviti početne korake kojima su krenuli autori u ovoj novoj seriji muzejskih izdanja, na tragu su inicijativa što ih Muzej nastoji poduzimati u želji da građu iz bogatoga spomeničkog fundusa pojedinih muzejskih zbirki učini pristupačnom stručnoj i široj zainteresiranoj javnosti.

Ante Rendić-Miočević

circumstances under which the items were found. Thereby, as the author herself pointed out, this work might serve as a basis for further research of the earliest prehistoric periods on the territory of eastern Slavonia and Srijem.

In this context the importance of this most recent scientific contribution by Jacqueline Balen, who has so far proved to be a prolific author of professional and scientific works as well as a committed head or collaborator in research activities of numerous important archaeological sites and above all, what is of great importance for the Museum, she was author and co-author of a line of Museum exhibitions. This publication, like all other that will hopefully follow the initial steps made by the authors of this first series of Museum editions, are now on the traces of the initiatives the Museum is trying to take wishing to make available to the professional and also broader public the materials stored in the rich holdings of the single Museum collections.

Ante Rendić-Miočević

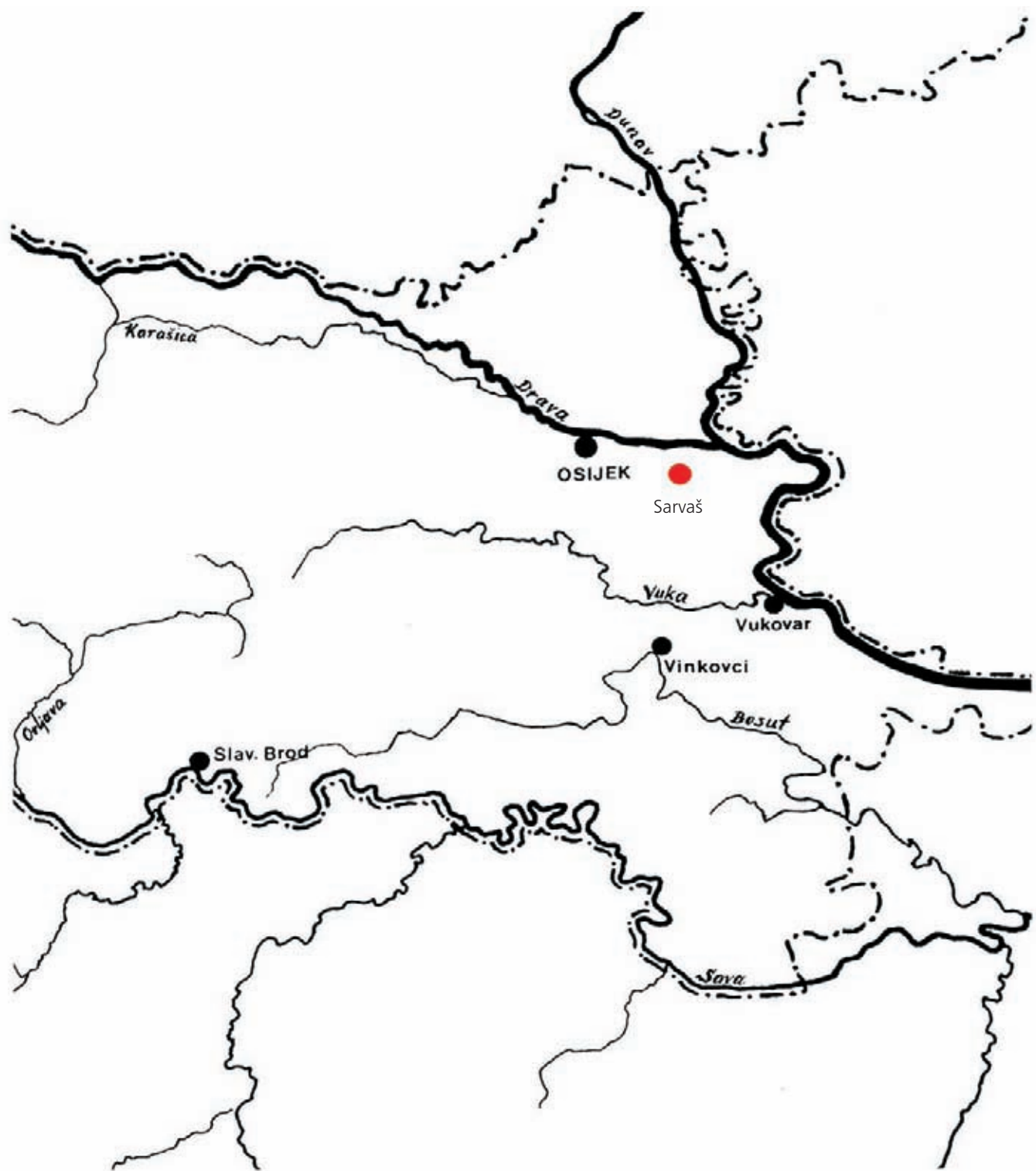

Sl. 1 položaj Sarvaša | Fig. 1 The Sarvaš position

## Uvod

Područje istočne Slavonije i Srijema, koje je pružalo povoljne uvjete za život populacija od kamenoga doba kontinuirano do današnjih dana, ima važnu ulogu u sagledavanju neolitičkih i eneolitičkih kultura. Naime, upravo je to matično područje nekih od njih (sopotske, kostolačke, vučedolske). Istočni hrvatski prostor zauzima jugozapadni dio Panonske nizine, odnosno istočni dio savsko-dravskoga međurječja. Istočna Hrvatska dio je velike međugorske zavale oblikovane između Karpata, Dinarida i Alpa. Taj je prostor, kao geomorfološki zatvorena cjelina, svojim položajem i prirodnim prometnicama, fluvijalnim nizinama i vodenim putovima usko povezan sa susjednim područjima te od pretpovijesti ima kontinuitet vrlo intenzivnoga života. Prema razlikama u geografskoj osnovi istočna se Hrvatska dijeli na istočnohrvatsku ravnicu i na Slavonsku Posavinu s Požeškom kotlinom. Istočnohrvatska ravnica obuhvaća ravničarske krajeve koji u povijesno-geografskom smislu pripadaju Slavoniji, Srijemu i Baranji.<sup>1</sup> To je otvoren, ravničarski kraj, najvećim dijelom sastavljen od mlađih riječnih naplavina i praporastih sedimenata. Najniži dio čine periodično plavljene aluvijalne ravni duž glavnih tekućica. Riječnim modeliranjem izdvojene su više ravnice. Najviši dio kraja imaju uzvišenja starije osnove, pokrivene pleistocenskim praporom naslagama. Praporna (lesna) uzvišenja su zbog svoga sastava suša, prirodno plodna te tako i ekološki povoljnija, pa su bila prije i dulje naseljena od prostranijih, relativno vlažnih i strukturno manje homogenih nizina koje ih okružuju.<sup>2</sup>

Geomorfološki razlikujemo tri velike cjeline, odnosno nizine rijeka Drave, Dunava i Save. Tu se prostiru dva praporna ravnjaka ili tektonska bloka: đakovačko-vinkovački i vukovarski. Vukovarsko-iločko pridunavlje osobito je pogodno za naseljavanje; naime otvoreni i dobro obrađeni praporni ravnjak završava prema Dunavu strmim relativne visine 30 – 50 m. U njemu su pritoci usjekli duboke i ponekad razgranate dolove. Na izlazu dolova u pridunavsku naplavnu ravnicu smještena je glavnina današnjih naselja (Sotin, Opatovac, Šaregrad).<sup>3</sup> Analognih je osobina, ali manjih razmjera, pojas na sastavu Dunava i Drave s Jabučkom kosom. Praporni strmci prema Dunavu i Dravi izrazit je kao i u vukovarsko-iločkom pojasu.

## Introduction

The region of eastern Slavonia and Srijem that has offered favourable living conditions for people from the Stone Age to this day has played an important role in the analysis of Neolithic and Eneolithic cultures. This is exactly where some of them originated from (e.g. Sopot, Kostolac, Vučedol). The eastern Croatian region covers the south-western part of the Pannonian lowland, i.e. the eastern part of the area between the Sava and Drava rivers. Eastern Croatia is part of the large mountain basin among the Carpathian Mountains, the Dinarides and the Alps. This area – a geomorphologically closed whole – is closely connected to its neighbouring areas due to its position and natural routes, fluvial lowlands and water paths. Since prehistoric times it has shown a continuous and high intensity of life. Based on its geographical differences eastern Croatia can be divided into the eastern Croatian plain and the Slavonian region around the river Sava (Slavonska Posavina) with the Požega basin. The eastern Croatian plain encompasses the lowland areas that from a historically-geographical point of view belong to Slavonia, Srijem and Baranja.<sup>1</sup> This is an open, lowland area, mainly consisting of younger river alluvium and loess sediments. The lowest part consists of periodically overflowing alluvial plains along major flowing waters. Due to river modelling the higher plains are isolated. The highest part of the landscape presents elevations of older base, covered up with pleistocene loess layers. Due to their constitution loess elevations are drier, naturally fertile and thus ecologically more favourable. They were inhabited earlier and longer than the more extensive, relatively wetter and structurally less homogeneous lowlands surrounding them.<sup>2</sup>

Geomorphologically seen, three major units can be identified: the lowlands of the Drava, the Danube and the Sava rivers. Two loess plains or tectonic blocks are present in this area: the Đakovo-Vinkovci and the Vukovar plain. The Vukovar-Ilok Danube area is particularly favourable for settling, in fact the open and well cultivated loess plain ends towards the Danube with a 30 – 50 meters high slope. Inside it the tributaries incised deep and sometimes ramified dales. At the exit of the dales in the Danube alluvial plain the majority of today's settlements is placed (Sotin, Opatovac, Šaregrad).<sup>3</sup> Of analogous features but of a smaller scale is the belt on the meeting point of the Danube and the

<sup>1</sup> Geografija 1975: 123.

<sup>2</sup> Geografija 1975: 11.

<sup>3</sup> Geografija 1975: 43–44.

Upravo zbog svih navedenih osobina, na kojima su naime nastali i razvili se današnji Osijek i Vukovar – na desnim obalama Drave i Dunava na prapornim uzvišenjima – taj kraj naseljavao je i u pretpovijesnim razdobljima.

Sve pretpovijesne kulturne pojave rezultirale su iznimnim bogatstvom arheoloških nalaza. Većina ih je pronađena slučajno, a tek malen dio rezultat je sustavnih arheoloških istraživanja. Prva su bila iskopavanja J. Victora u Samatovcima i V. Celestina na Hermanovu vinogradu u Osijeku.<sup>4</sup> Godine 1897., kada V. Celestin provodi iskopavanja u Osijeku, J. Brunšmid obavlja manja istraživanja na Vučedolu. Nakon toga veća iskopavanja poduzeta su u Dalju pod vodstvom V. Hoffillera te na Vučedolu i Sarvašu pod vodstvom njemačkoga arheologa R. R. Schmidta,<sup>5</sup> koji je u svom sinteznom radu sistematizirao neolitičke i eneolitičke kulture tih krajeva, pa je njegov rad, unatoč mnogim krivim interpretacijama, kapitalno i još i danas citirano djelo. U prvom desetljeću nakon II. svjetskog rata obavljana su iskopavanja na položaju Vukovar – Lijeva bara i u Belom Manastiru.<sup>6</sup> U 1960-im i 1970-im godinama niz iskopavanja pokrenuo je S. Dimitrijević, većinom na području djelovanja vinkovačkoga muzeja (Otok, Sopot, zaštitna iskopavanja u Vinkovcima i dr.),<sup>7</sup> a 1980-e i 1990-e obilježila su velika zaštitna iskopavanja na trasi auto-ceste Slavonski Brod – Lipovac,<sup>8</sup> te sustavna iskopavanja Vučedola od 1984. do 1990.<sup>9</sup>

Danas se zbog gradnje mnogih prometnica intenziviraju zaštitna iskopavanja, kojima se mogu pokriti, odnosno istražiti dosta velike površine, te se tako može doći do iznimno korisnih novih spoznaja o našoj arheološkoj baštini. Međutim, uglavnom je riječ o jednoslojnim nalazištima s horizontalnom stratigrafijom, koja, iako mogu dati puno podataka o organizaciji naselja pojedine pretpovijesne populacije, ne otkrivaju i kronološke odnose među pojedinim kulturnim pojavama.

Sustavnih je istraživanja puno manje, a valja spomenuti ona koja vodi K. Minichreiter na Galovu u Slavonskome Brodu, gdje se od 1997. god. istražuje naselje starčevačke kulture,<sup>10</sup> zatim iskopavanja M. Krznarić-Škrivanko na eponimnom nalazištu sopotske kulture u Vinkovcima,<sup>11</sup> te naposljetku istraživanja na položaju vinograda Streim na Vučedolu, koja su se ponovno intenzivirala od 2000. pod vodstvom A. Durmana.<sup>12</sup>

Posljedica različita intenziteta iskopavanja pojedinih područja i pojedinih kultura jest neravnomjerno poznavanje pojedinih kulturnih pojava neolitika i eneolitika. Zbog nedovoljna broja sustavnih iskopavanja višeslojnih nalazišta još nije moguće određivanje prave kronološke pozicije pojedinih kultura s tih prostora.

Drava rivers with the Jabučka kosa. The loess slope towards the Danube and the Drava rivers is as pronounced as the belt of the Vukovar-Ilok area.

Due to all listed features on the basis of which today's Osijek and Vukovar were established and developed – on the right side banks of the Danube and Drava rivers, at loess elevations – this area was inhabited also at prehistoric times.

All prehistoric cultures resulted in an exceptional richness of archaeological finds. Unfortunately, the majority were chance finds – only a small number of them were the result of systematic archaeological excavations. The first that can be listed are the excavations made by J. Victor in Samatovci and V. Celestin in the Herman vineyard in Osijek<sup>4</sup>. J. Brunšmid carried out minor excavations at Vučedol, thereafter larger excavations were performed in Dalj under the leadership of V. Hoffiller and at Sarvaš under R.R. Schmidt.<sup>5</sup> In his synthetic work the German archaeologist systematized the Neolithic and Eneolithic cultures of our regions and still today represents a capital and frequently cited work in spite of its numerous misinterpretations. In the first after war decade excavations were carried out on the location of Vukovar – Lijeva bara and Beli Manastir.<sup>6</sup> In the sixties and seventies a sequence of excavations was carried out by S. Dimitrijević, mainly on the field of action covered by the Vinkovci Museum (Otok, Sopot, protection excavations in Vinkovci and others)<sup>7</sup>. The eighties and nineties were characterized by large protection excavations on the high-way section Slavonski Brod – Lipovac<sup>8</sup> and systematic excavations at Vučedol from 1984 to 1990.<sup>9</sup>

Today, due to the construction of highways, protection excavations are being intensified, whereby large surfaces are explored and exceptionally useful, new insights are gained into our archaeological heritage. However, these insights mainly concern single-layered sites with a horizontal stratigraphy that convey a lot of information about the settlements organisation of a single prehistoric population. They, however, do not provide information about the chronological relations among the single cultures.

Systematic excavations are much fewer. We can name those carried out by K. Minichreiter at Galovo in Slavonski Brod – where the settlement of the Starčevo culture<sup>10</sup> has been explored since 1997 – followed by M. Krznarić-Škrivanko on the homonymous site of the Sopot culture in Vinkovci,<sup>11</sup> and finally the explorations of the Streim vineyard at Vučedol that have been intensified since 2000 under the leadership of A. Durman.<sup>12</sup>

The consequence of the different intensity of the single fields and the single cultures is the uneven knowledge of the Neolithic and Eneolithic cultures. Also, the insufficient number of systematized excavations of multi-layered sites still does not enable us to determine the correct chronological position of the single cultures that inhabited these territories.

<sup>4</sup> Victor 1870; Celestin 1897.

<sup>5</sup> Schmidt 1945.

<sup>6</sup> Vinski 1955; Vinski-Gasparini 1956.

<sup>7</sup> Dimitrijević 1966.

<sup>8</sup> Minichreiter 1991.

<sup>9</sup> Za detaljniji popis iskopavanja vidi Marković 1994: 11–13.

<sup>10</sup> Minichreiter 2005: 25.

<sup>11</sup> Krznarić-Škrivanko 2003.

<sup>12</sup> Durman et al. 2003: 46–50.

Pojedine kulture dosta su dobro sistematizirane,<sup>13</sup> ali je još uvijek za većinu od njih najcitiranije i najvažnije djelo *Praistorija jugoslavenskih zemalja* (svezak II i III, Sarajevo, 1979). U novije doba sintezne prikaze neolitičkih i eneolitičkih kultura dali su Z. Marković i T. Težak-Gregl.<sup>14</sup>

Osobit je problem i činjenica što je velika količina iskopane građe neobjavljena. Za sagledavanje cjelokupne slike neke kulturne pojave iznimno je važna kataloška obradba građe. Iako je znanstveno najupotrebljiviji materijal koji potječe iz sustavnih istraživanja, u njihovu pomanjkanju potrebno je napraviti i katalog postojeće građe iz muzejskih čuvaonica, koja iako bez stratigrafskih pokazatelja daje uvid u bogatu arheološku baštinu te može poslužiti kao temelj za dalja istraživanja. Takvih je monografskih objava pretpovijesnih nalazišta s prostora Hrvatske vrlo malo. U posljednje su doba objavljene dvije monografije, odnosno cjelovite obradbe i interpretacije građe s dvaju važnih nalazišta, koje će pomoći u razrješavanju problema kronologije istočne jadranske obale.<sup>15</sup> Do sada takvih djela o području kontinentalne Hrvatske nema.

Za rješavanje relativno-kronoloških i apsolutno-kronoloških problema posebno je važna vertikalna stratigrafija višeslojnih nalazišta. Skupini nalazišta koja imaju šire značenje za stvaranje kronoloških pitanja i međusobnih odnosa kultura pripada nalazište Sarvaš. Ono je uz Vučedol, Bapsku te Vinkovce, najčešće u literaturi spominjano višeslojno nalazište, pa je nužno uključeno u različite problemske kontekste za rješavanje kronoloških pitanja Podunavlja.

Naselje Sarvaš u znanstvenoj je literaturi poznato od početka 20. stoljeća. Iako su na tom nalazištu veća iskopavanja vođena 1942/43 godine, materijal s iskopavanja, iako često citiran u arheološkoj literaturi, nije nikada detaljno objavljen, a zbog pomanjkanja dokumentacije s istraživanja postao je znanstveno neupotrebljiv. Nalazi iz navedenih iskopavanja doživjeli su još jednu neugodnu sudbinu – podijeljeni su između dviju muzejskih ustanova: zagrebačkoga i osječkoga muzeja.

Upravo zato odlučili smo se na jednom mjestu skupiti sve nalaze iz Sarvaša iz kamenoga i bakrenoga doba koji se čuvaju u Arheološkom muzeju u Zagrebu. Naravno, ovom objavom nismo imali nikakvu pretenziju izvršiti reviziju arheoloških slojeva iz iskopavanja provedenih tijekom II. svjetskog rata, s obzirom na to da se taj materijal čuva u dvama odvojenim muzejskim fondovima (veći je dio građe u Osijeku), a dokumentacija nije sačuvana, nego smo odlučili napraviti katalošku obradbu građe koja se čuva u Arheološkom muzeju u Zagrebu, uključivši pritom i sve nalaze prikupljene prije provedenih istraživanja.<sup>16</sup> Nadamo se da će ovaj rad poslužiti upotpunjavanju tipološke slike pojedinih kultura iz razdoblja mlađega kamenog i bakrenog doba.

Single cultures have been well systematized.<sup>13</sup> However, for the majority of them, still, the most cited and most important work is the *Praistorija jugoslavenskih zemalja* (*Prehistory of South Slavic Countries, fasc. II and III, Sarajevo, 1979*). In earlier times synthetic surveys of Neolithic and Eneolithic cultures have been produced by Z. Marković and T. Težak-Gregl.<sup>14</sup>

A major problem is the fact that a large amount of excavated materials has not been published yet. For gaining an overall picture of a culture, it is of great importance to have a catalogue analysis of the material. Although, from a scientific point of view the most useful material comes from systematic research, if there is lack of such work, it is necessary to draft a catalogue of the existing materials from the museum conservation room, which regardless of the lack of stratigraphic indicators still gives an insight into the rich archaeological heritage and can be used as a basis for further research. From the Croatian area there are few such monographic publications. Lately, two monographies have been published, i.e. overall analysis and interpretations of the materials from two important finding sites, that will help in solving the problems concerning the chronology of the eastern Adriatic coast.<sup>15</sup> Such works about the continental part of Croatia are still not available.

In order to solve the relative-chronological and absolute-chronological problems, the vertical stratigraphy of multi-layered finding sites is of particular importance. The finding site of Sarvaš belongs to the group of finding sites that have a larger meaning for the creation of chronological issues and relations among cultures. Sarvaš is alongside with Vučedol, Bapska and Vinkovci the most frequently mentioned multi-layered site in the literature, and is thus included into various problematic contexts with the aim of solving chronological problems concerning the Danube area.

The Sarvaš settlement has featured in the scientific literature since the beginnings of the 20th century. Although major excavations were carried out at this site in 1942/43, the material from the excavation – although frequently quoted in the archaeological literature – has never been published in detail, and due to the lack of documentation from the excavations, it has become scientifically useless. The finds from the named excavations had to experience yet another unpleasant destiny – they were divided between the Zagreb and Osijek museums.

This is why we decided to gather on one place all the finds from the Sarvaš Stone and Copper Age stored in the Archaeological Museum in Zagreb. With this publication we naturally had no pretensions to review the archaeological strata of the excavations carried out after World War II, since the material is being stored in two separate museum holdings (the majority is stored in Osijek) and the documentation has not been preserved. We decided to carry out a catalogue analysis of the material that is stored in the Archaeological Museum in Zagreb, including all finds collected before the research.<sup>16</sup> Hopefully, this work will contribute towards completing the typological picture of single cultures from the periods of the Late Stone Age and the Copper Age.

<sup>13</sup> Minichreiter 1992a (starčevačka kultura); Težak-Gregl 1993 (kultura linearno-trakaste keramike).

<sup>14</sup> Marković 1994; Težak-Gregl 1998.

<sup>15</sup> Čečuk & Radić 2005 (Vela Spila); Marijanović 2005 (Gudnja).

<sup>16</sup> Zbog navedenih razloga odlučili smo se da građu u Katalogu, koji se nalazi na kraju monografije, poredamo po kulturnoj pripadnosti, vrsti materijala te tipološki, a ne, kao što je uobičajeno, po stratigrafskim cjelinama. Kada je riječ o građi koja potječe sa Schmidtovih istraživanja uz inventarni broj naveli smo kvadrant i dubinu, tj. sve nama dostupne podatke.



14

**Sl. 2** pogled s lokaliteta na stari tok Drave (snimio I. Marović, 1942. god.) | **Fig. 2** View from the location onto the old flow of the Drava River (photographed by I. Marović, 1942.)



**Sl. 3** pogled s lokaliteta na stari tok Drave (snimio I. Marović, 1942. god.) | **Fig. 3** View from the location onto the old flow of the Drava River (photographed by I. Marović, 1942.)

## Povijest i stanje istraživanja nalazišta

Nalazište Sarvaš nalazi se 15-tak kilometara istočno od Osijeka, na desnoj obali mrtvoga rukavca Drave, na blago valovitom području koje se nastavlja sve do Daljske planine. Lokalitet se nalazi na sjeverozapadnome kraju sela, na nadmorskoj visini od 95 do 100 m. Riječ je o telu nepravilna oblika, dimenzija 175 x 155 m, koji se danas izdiže 9 m od okolnog područja. Sjeverna strana okomito se ruši u 15 m niži riječni rukavac, a na istoku je tel presječen cestom. Najpogodniji je prilaz s juga, a s jugoistočne i zapadne strane intervencije su načinjene vjerojatno u razdoblju mlađega željeznog doba.

Prvi nalazi s položaja Vlastelinski brijeg ili Gradac prikupljeni su između 1890. i 1895. pri obnavljanju vinograda. Na početku 20. st. započele su prve znanstvene objave, uglavnom vučedolske građe (tada slavonske kulture).<sup>17</sup> Neki od tada prikupljenih predmeta nalaze se u Beču i Berlinu,<sup>18</sup> a većina ih je prosljeđena u Arheološki muzej u Zagrebu. Iz tog razdoblja potječe i djelo V. Hoffillera, u kojem objavljuje izbor sarvaškoga materijala iz fundusa Arheološkoga muzeja u Zagrebu.<sup>19</sup>

Prva iskopavanja na Sarvašu izveo je C. F. Nuber, osječki trgovac i jedan od utemeljitelja današnjega Muzeja Slavonije u Osijeku.<sup>20</sup> Njegovim iskopavanjem najviše je skupljeno keramike koju pripisujemo vučedolskoj kulturi.<sup>21</sup>

Prvo veće arheološko iskopavanje na položaju Gradac poduzeo je tijekom 1942. i 1943. godine njemački arheolog R. R. Schmidt.<sup>22</sup> Iskopavanje je obavljeno, s prekidima, u dva navrata: od 13. V. do 21. XI. 1942. te od 27. IV. do 29. V. 1943. u trajanju od 28 tjedana.<sup>23</sup> Iskopana površina bila je podijeljena na kvadrante (blokove) veličine 5 x 5 m. Ukupno je iskopano 28 kvadranta,<sup>24</sup> odnosno 700 m<sup>2</sup>. Schmidtova je nakana bila da sav iskopani materijal smjesti u novoosnovani njemački

## Historic overview and exploration status of the site

The finding site of Sarvaš is located about 15 kilometres eastern from Osijek, on the right bank side of Drava's stagnant backwater, on a slightly wavy field that stretches till the Dalj Mountain. The site is situated on the north-west of the village, at 95 to 100 meters of altitude. It is a tell of irregular shape (the tell's dimensions are 175 x 155 meters) that today is elevated nine meters from the surrounding field. The northern part falls diagonally in a 15 meters lower backwater, and is interrupted by the road on the east. The most favourable access is from the south whereas from the south-east and northern side interventions were made, probably in the course of the Late Iron Age.

The first findings from *Vlastelinski brijeg (hill)* or *Gradac* were found during 1890-1895 vineyard renovations. The first scientific publications started at the beginning of the 20th century, mainly concerning the Vučedol materials (at that time Slavonian culture).<sup>17</sup> Some of the then gathered artefacts are even displayed in Vienna and Berlin.<sup>18</sup> However, the majority was sent to the Archaeological Museum in Zagreb. From this period originates also a work by Viktor Hoffiller, in which he published a selection of Sarvaš materials from the holdings of the Archaeological Museum of Zagreb.<sup>19</sup>

The first excavations at Sarvaš were carried out by C.F.Nuber, Osijek trader and one of the founders of today's Museum of Slavonia in Osijek.<sup>20</sup> During his excavations also the majority of pottery was found that is attributed to the Vučedol culture.<sup>21</sup>

The first major archaeological excavations at the Gradac location were carried out by the German archaeologist R. R. Schmidt<sup>22</sup> during 1942 and 1943. The excavation works – carried out in two phases with breaks– from 13.5. till 21.11. 1942 and from 27.4. till 29.5. 1943 lasted for 28 weeks<sup>23</sup>. The excavated

<sup>17</sup> Hoernes 1901:276; Wosinsky 1904: 43, 44, T. XVIII; Hoernes & Menghin 1925: 340, 764; Childe 1929: 210; Schuchhardt 1926: 153; Reinecke 1897: 78.

<sup>18</sup> Čest je slučaj bio da su seljaci pronađenu građu prodavali izvan granica zemlje. O tome svjedoči i jedan dopis koji se čuva u Arhivu Arheološkoga muzeja u Zagrebu (dalje AMZ) iz 1906. upućen Karlu Penzingeru o zabrani prodaje građe izvan granica (br. 27/1906).

<sup>19</sup> Hoffiller 1938.

<sup>20</sup> Bosendorfer 1942: 17.

<sup>21</sup> Šimić 1991: 6.

<sup>22</sup> Schmidt 1945: 127–131.

<sup>23</sup> Grubišić 2002: 117–130.

<sup>24</sup> Kvadranti su bili označeni brojevima od 1 do 25 te slovima A i B, a jedan kvadrant nosio je oznaku 10 A.





Sl. 4 R. R. Schmidt i V. Hoffiller tijekom iskopavanja Sarvaša 1942. god. (snimio I. Marović) | Fig. 4 R. R. Schmidt and V. Hoffiller during the Sarvas excavations in 1942 (photographed by I. Marović)



Sl. 5–9 fotografije snimljene tijekom iskopavanja 1942. god. (snimio I. Marović) | Fig. 5–9 Photographs taken during the 1942 excavations (photographed by I. Marović)



Sl. 10–14 fotografije snimljene tijekom iskopavanja 1942. god. (snimio I. Marović) | Fig. 10–14 Photographs taken during the 1942 excavations (photographed by I. Marović)

muzej u Osijeku, no zbog ratnih okolnosti promijenio je plan te zemlju napustio s cjelokupnom iskopanom građom.

Iako se u literaturi navodi da je na kraju II. svjetskog rata materijal s iskopavanja na putu za Njemačku zaustavljen u Češkoj te vraćen u Beograd, istina je da je materijal već potkraj 1944. bio prebačen u dvorac Lämberg u Austriji,<sup>25</sup> a kada je dospio u Beograd ne zna se. U spisima se navodi da je repatriiran 1946. godine, međutim zna se da je u Beogradu bio već 1945. godine. Podjela repatriiranoga materijala zbila se tek 1948., kada je iz Beograda dopremljen u Arheološki muzej u Zagrebu. Tijekom svibnja i lipnja 1948. cjelokupna građa bila je postavljena na velikoj izložbi u prostorijama Muzeja (sl.15), a nakon toga je podijeljena između Zagreba i Osijeka.

Za razliku od materijala, dokumentacija i rukopis završene publikacije nisu spašeni. Sačuvan je samo blok sa stratigrafskim skicama iz 1942. U literaturi se spominje da je dokumentacija izgorjela pri bombardiranju potkraj rata. Naime, Dimitrijević navodi da je Schmidt potkraj 1944. imao gotov rukopis monografije, ali da su mu na povratku u Njemačku rukopis i sva dokumentacija, osim tabli i jednog terenskog bloka s crtežom profila, izgorjeli.<sup>26</sup>

Schmidt je u monografiji *Die Burg Vučedol* dao kratak izvještaj o provedenim istraživanjima Sarvaša, objavivši nekoliko predmeta te stratigrafiju sjevernoga profila:<sup>27</sup>

0,00 – 0,50	VIII	slavensko razdoblje
	VII	rimsko razdoblje
0,50 – 1,00	VI	latensko naselje
1,00 – 2,00	V	brončano doba
2,00 – 3,00	IV	vučedolsko naselje
3,00 – 3,60	III	badensko naselje, apsidalne kuće
3,60 – 4,90	II	neolitičko naselje, protobadenska kultura
4,90 – 7,40	Ib	neolitičko naselje, starčevačka kultura
7,40 – 8,20	Ia	neolitičko naselje sa zemunicama

Sačuvana dokumentacija dospjela je kod V. Milojčića u Heidelberg, gdje je bila do njegove smrti. Na temelju tih podataka on je napravio pregled iskopavanja te nešto dopunjenu stratigrafiju Sarvaša:<sup>28</sup>

- rimsko i srednjovjekovno naselje
- latensko naselje s opkopom i palisadama
- 1,00 – 2,00 – brončanodobni horizont s ostatcima kuća i kasnobrončanodobne i halštatske jame
- 2,00 – 3,00 – horizont vučedolske kulture
- 3,00 (3,30) – 3,60 (4,00) – badenski sloj; nalaz apsidalne kuće
- 3,60 – 4,90 – u istom sloju navodi da se javlja i tipičan slavonsko-srijemski neolitik te keramika koja se može pripisati badenskoj kulturi
- 4,90 – 7,00 – neolitički stambeni horizont
- 7,00 – 7,40 – pretpovijesni humus
- 7,40 – 8,20 – neolitički ukopi u zdravici; osim grube kućne

surface was divided into quadrants (blocks) of a size of 5 x 5 m. An overall number of 28 quadrants was excavated which corresponds to 700 m<sup>2</sup>.<sup>24</sup> It was Schmidt's intention to place the whole excavated material in the newly established German Museum in Osijek. However, due to the War he changed his plan and left the country with all the excavated material.

Although, in the literature it is stated that at the end of World War II the excavated material was stopped at the Czech border on its way to Germany and returned to Belgrade, the truth is it was relocated to the Lämberg castle in Austria<sup>25</sup> as early as at the end of 1944. The exact date of its relocation to Belgrade is not known. According to the writings the materials were repatriated in 1946, we know they were in Belgrade already in 1945. The division of the repatriated material took place as late as 1948, when the material was shipped from Belgrade to the Archeological Museum in Zagreb. During May and June 1948 the whole materials were displayed in the big exhibition in the museum premises (fig.15) and were later on divided between Zagreb and Osijek.

Unlike the materials, the documentation and the manuscript of the completed publication have not been preserved. The only preserved item is a block with stratigraphic drafts from 1942. According to the literature the documentation burned out during a bombing at the end of the war. In fact, Dimitrijević states that Schmidt had a final manuscript of the monograph at the end of 1944, but all writings and documentation – except for the tables and a block with the profile drawing – burned out on his trip back to Germany<sup>26</sup>.

In the monograph »Die Burg Vučedol« Schmidt gave a short survey of the research done in Sarvaš, publishing some items and the stratigraphy of the northern profile:<sup>27</sup>

0,00 - 0,50	VIII	Slavic period
	VII	Roman period
0,50 - 1,00	VI	La Tene settlement
1,00 - 2,00	V	Bronze Age
2,00 - 3,00	IV	Vučedol settlement
3,00 - 3,60	III	Baden settlement, apsidal houses
3,60 - 4,90	II	Neolithic settlement, proto Baden culture
4,90 - 7,40	Ib	Neolithic settlement, Starčevo culture
7,40 - 8,20	Ia	Neolithic settlement with pit dwellings

The preserved documentation reached V. Milojčić in Heidelberg where it remained until his death. On the basis of it, Milojčić made an overview of the excavations and a more complete stratigraphy of the Sarvaš<sup>28</sup>:

- Roman and Middle Age settlement
- La Tène settlement with ditch and palisades
- 1,00 – 2,00 – Bronze Age horizon with house rests and Late Bronze Age and Hallstatt pits
- 2,00 – 3,00 – Vučedol culture horizon
- 3,00 (3,30) – 3,60 (4,00) – Baden layer; find of an apsidal house

<sup>25</sup> Grubišić 2002: 126–127.

<sup>26</sup> Dimitrijević 1968: 26; isti 1969a: 68, bilješka 13.

<sup>27</sup> Schmidt 1945: 127–131, 141–142, 145–146.

<sup>28</sup> Milojčić 1949: 82–90.

## Izložba predmeta iz kamenog i bakrenog doba

OVA ZANIMLJIVA IZLOŽBA U ARHEOLOŠKOM MUZEJU OSTAJE OTVORENA DO KRAJA LIPNJA

Prvi predmeti iz prahistorijske naseobine kod Vukovara došli su u zagrebački Arheološki muzej godne 1896. U to su vrijeme obnovljeni vinogradi uništeni filokserom, pa je tako i vukovarski apotekar Strain rigolao svoje zemljište na Vučedolu kod Vukovara, da zasadi nov vinograd američkom lozom. Pri tome poslu iskopao je mnogo predmeta, naročito zemljanih posuda, krasno urešenih, i sve je te predmete, osim malog broja, vlasnik poklonio našem muzeju.

G. 1938. iskopavalo se, također u Vučedolu, od lipnja do prosinca na malenom humku, pet metara duboko, pa su se našli temelji triju kuća još iz kamenog doba. Dvije polukružne ležale su 2,80 m ispod površine humka. Bit će da su tu stanovali kulturniji ljudi, jer kuće imaju pod od nabijena ilovaca.

Ova kultura kamenoga doba bila je naglo prekinuta i nije se odmah nastavila, jer se nađ tim slojem, u kojemu ima tragova kulture, nalazi metar visoki sloj bez traga kulturnijeg života. Kamenog doba bilo je tu oko godine 3000 prije naše ere. Tisuću godina kasnije, oko godine 2000 prije naše ere došao je na to mjesto nov narod, koji je poznavao bakar i obradivao ga. Iz toga vremena potječe jedna kuća u obliku starogrčkoga megarona s dvije prostorije, iskopana u dubini od 1,80 m, i tu se jasno vidi utjecaj Orijenta, Troje i Egejskih otoka, gdje su se također u bakreno doba našle takve kuće, koje su dale i tlorise kasnijih grčkih hramova. I ti predmeti, iskopani g. 1938. smješteni su u zagrebački Arheološki muzej i obogatili su naše znanje o toj naseobini. Mnogi predmeti pokazuju veze s otokom Kretom i Malom Azijom.

Slična naseobina bila je na starom dravskom rukavu u selu Sarvašu, prvoj željezničkoj stanici iza Osijeka (došnjega grada) prema Vukovaru. Naseobina je vidljiva po dosta visokom i prostranom humku zasadenom obnovljenim vinogradima. Kod rigoliranja našlo se i tu mnogo glinenih bogato ornamentiranih posuda, od kojih je dosta velik broj dospio u zagrebački Arheološki muzej. Iskapanja na jednom dijelu toga humka vršili su za vrijeme rata Nijemci, koji su u Osijeku počeli graditi ogromnu zgradu za njemački muzej, a u taj su se muzej

imali smjestiti i ovi predmeti iskopani u Sarvašu. Napuštajući naše zemlje Nijemci su ponijeli i predmete iskopane u Sarvašu, koji na sreću nisu stigli do Njemačke nego su zaustavljeni u Čehoslovačkoj i vraćeni u Beograd. Činovnici zagrebačkog Arheološkog muzeja pregledali su 110 sanduka povraćanog materijala. Materijal je bio najviše arhivski, koji uglavnom pripada Novom Sadu, a osječki materijal nalazio je u 18 sanduka, i ti su dopremljeni u Zagreb. Materijal iskopan u Sarvašu određen je za državni muzej u Osijeku, pa će se onamo i poslati. Materijal je krasan i sada je izložen u Arheološkom muzeju.

Zbog velikog zanimanja za lijepu i poučnu izložbu predmeta iz kamenoga i bakrenog doba, iskopanih u bogatim prahistorijskim naseobinama na ušću Drave i na Dunavu ispod Vukovara, ova izložba u Arheološkom muzeju na Zrinjskom trgu broj 19 ostaje otvorena još cijeli mjesec lipanj.



REKONSTRUIRANA PRAHISTORIJSKA NASEOBINA NA VUČEDOLU KOD VUKOVARA

# NJE I. RAZREDA DRŽAVNE KLASI

Adresa: ZAGREB, GAJEVA ULICA 3, ILICA 5, ILICA 16 – S.P.L.I.T. NARODNI

„Narodni list“ 3. VI. 1948.

Sl. 15 Isječak iz novina o izložbi predmeta iskopanih u Vučedolu i Sarvašu, arhiv AMZ – a I

Fig. 15 A newspaper cutting about the exhibition of artefacts from Vučedol and Sarvaš, Archives of the AMZ

keramike ukrašene impressom i barbotinom, također spominje bojanu i crnu glačanu keramiku, koju uspoređuje s ranom vinčanskom kulturom.

Milojčić navodi da je stratigrafija prilično nesigurna zbog postojanja latenskoga rova koji je oštetio slojeve. Na temelju materijala i slojeva podijelio je Sarvaš na 5 faza:

- I starčevačka kultura
- II slavonsko – srijemska kultura (op.a. sopotska)
- III badenska kultura
- IV vučedolska kultura
- V brončano doba

O postojanju rova svjedoči i izvješće M. Šepera koje se čuva u Arhivi AMZ-a:<sup>29</sup>

Po svom dolasku u Osiek /24.V./ odmah sam se stavio u vezu s R. R. Schmidtom. Za čitavog svog boravka u Osijeku /od 25.V. – 1.VI./ i od /4.VI. – 9.VI./ bio sam dnevno na izkapanjima, koje prof. Schmidt vodi na Gospodskom briegu u Sarvašu.

- 3,60 – 4,90 – In the same layer the appearance of a typical Neolithic of the Slavonian-Srijem region is mentioned and also of pottery that can be ascribed to the Baden culture
- 4,90 – 7,00 – Neolithic living horizon
- 7,00 – 7,40 – Prehistoric humus
- 7,40 – 8,20 – Neolithic internments in virgin soil; except for coarse household pottery decorated by impression and barbotine, coloured and black polished and compared it to the early Vinča culture.

Milojčić states that the stratigraphy is pretty unsure due to the existence of La Tène trenches that damaged the layers. On the basis of the materials and the layers he divided the Sarvaš into 5 phases:

- I the Starčevo culture
- II the Slavonian – Srijem culture (author's comment: Sopot culture)
- III the Baden culture
- IV the Vučedol culture
- V the Bronze Age

Čitavo nalazište u cjelini nije toliko zanimljivo, kao ono na Vučedolu, budući da je u latenu kroz iskopani dio briega bio iskopan šanac tako, da su se kulturni slojevi prekinuli. Na taj se način tlorici kuća nisu mogli jasno dobiti, kao što je bio slučaj s Vučedolom. Baš to je bio i razlog, da su poremećini i grobovi i da su i ostali nalazi u mnogome fragmentarni. Od nalaza ima nekoliko liepih varianata vučedolske keramike, nešto oblika, koji se na Vučedolu nisu javljali, a među njima u prvom redu tzv. prstenaste boce /Ringflasche/.

Reviziju stratigrafije napravio je S. Dimitrijević na temelju dostupne mu dokumentacije. Zaključio je da je stratigrafija Sarvaša na kopanoj površini gotovo neupotrebljiva.<sup>30</sup> U blokovima 13–15, 18–20, 23–25 došlo je do uleknuća slojeva velikih dimenzija: tako na dubini od 2 m uleknuće iznosi 12 m. On smatra da slojevi nisu poremećeni od palisadnog opkopa iskopana u mlađem željeznom dobu, već od prirod-noga tektonskog slijeganja, vjerojatno jednoga, prirodnim putem zatrpana rukavca rijeke Drave. Prema dopunjenoj stratigrafiji blokova 15, 20 i 25 (radi se o intaktnim blokovi-ma na jugoistočnoj strani) donosi sljedeću stratigrafsku sliku (sl.16):<sup>31</sup>

- |                       |   |
|-----------------------|---|
| 1. — — —              | starčevačka kultura                               |
| 2. — — 5,50           | sopotska kultura                                  |
| 3. 5,50 – 4,00        | badenska kultura, stariji građevinski horizont    |
| 4. 4,00 – 3,20 (3,00) | badenska kultura, mlađi građevinski horizont      |
| 5. 3,20 – 2,60        | vučedolska kultura, stariji građevinski horizont  |
| 6. 2,60 – 2,00        | vučedolska kultura, mlađi građevinski horizont    |
| 7. 2,00 – 1,00        | brončanodobni horizonti                           |
| 8. 1,00 – 0,00        | halštatski, latenski, rimski i slavenski horizont |

O Schmidtovim iskopavanjima su mišljenja podosta oprečna. Za razliku od iskopavanja na vučedolskom Gradcu tijekom 1938., koja je vodio sustavno i sistematično, ratna iskopa-vanja Sarvaša povezana su najviše s činjenicom da je otuđio iskopanu građu te tako grubo prekršio zakone i etiku.

The report by M. Šeper – stored in the Archives of the Archaeological Museum in Zagreb – also gives testimony of the existence of ditch<sup>29</sup>.

After reaching Osijek /24<sup>th</sup> May/ I immediately contacted R. R. Schmidt. Throughout my stay in Osijek /from 25<sup>th</sup> May – 1<sup>st</sup> June./ and from /4<sup>th</sup> June – 9<sup>th</sup> June/ I attended excavations led by prof. Schmidt on Gospodski brijeg at Sarvaš on a daily basis. The whole finding site is not as interesting as the one at Vučedol, since in the La Tène period through the excavated part of the hill, a ditch was excavated in such a way to interrupt the cultural layers. Therefore, the houses' ground-plans could not be revealed – as it was the case at Vučedol - which is why the graves are deranged and the remaining finds are fragmentary. Among the finds there are a few beautiful varieties of Vučedol pottery, some shapes that did not appear at Vučedol at all and among them in the first place is the so called ring-shaped bottles /Ringflasche/

A revision of the stratigraphy was made by S. Dimitrijević on the basis of the documentation available to him. He concluded that the Sarvaš stratigraphy on the barrowed surface is almost useless.<sup>30</sup> In the blocks 13–15, 18–20, 23–25 swales of large layers appeared so that at the depth of 2 m the swale is 12 m. He believes that the layers were not deranged due to the excavated in the Late Iron Age, but rather due to the natural tectonic settling, probably of one, burying the Drava effluent (armband) in a natural way. According to the updated stratigraphy of blocks 15, 20 and 25 (these are intact block at the south-eastern side) he conveys the following stratigraphic (fig.16):<sup>31</sup>

- |                       |   |
|-----------------------|---|
| 1. — — —              | the Starčevo culture                              |
| 2. — — 5,50           | the Sopot culture                                 |
| 3. 5,50 – 4,00        | the Baden culture, older construction horizon     |
| 4. 4,00 – 3,20 (3,00) | the Baden culture, younger construction horizon   |
| 5. 3,20 – 2,60        | the Vučedol culture, older construction horizon   |
| 6. 2,60 – 2,00        | the Vučedol culture, younger construction horizon |
| 7. 2,00 – 1,00        | Bronze Age horizons                               |
| 8. 1,00 – 0,00        | Hallstatt, La Tène, Roman and Slavic horizon      |

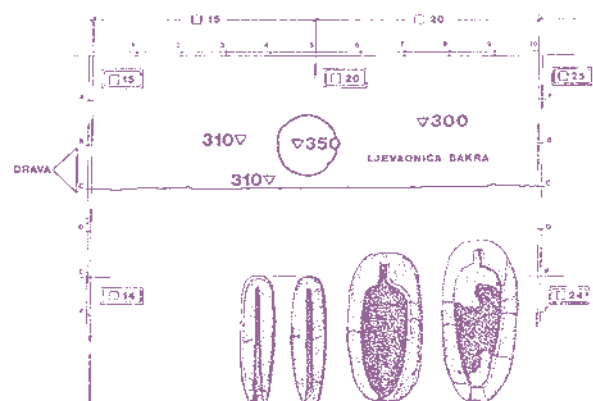
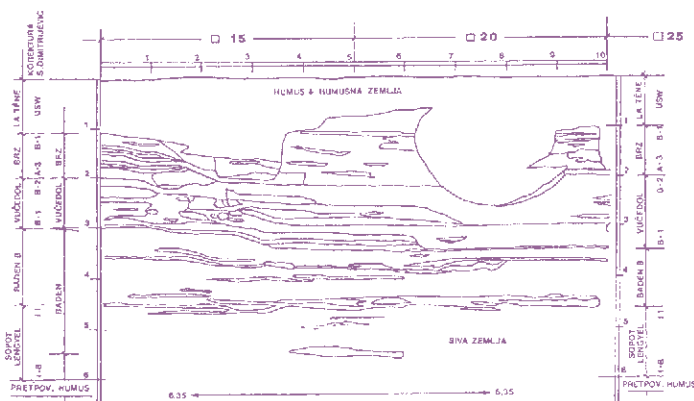

Sl. 16 crtež profila i tlocrt jame u kojoj su nađeni kalupi za lijevanje (po R. R. Schmidtu i S. Dimitrijeviću) | Fig. 16 Profile drawing and ground-plan of the pit in which casting molds have been found (after R. R. Schmidt and S. Dimitrijević)

<sup>29</sup> Arhiv AMZ, br. 261/1943.

<sup>30</sup> Dimitrijević 1968: 26–27.

<sup>31</sup> Dimitrijević objavljuje i crtež profila navedenih blokova, odnosno kvadrana, vidi: Dimitrijević 1971: sl. 2.

To mišljenje potvrđuje nam i jedna rečenica iz dopisa V. Hoffillera upućena tadašnjem Ministarstvu prosvjete, koji se čuva u Arheološkome muzeju:

*S iskapanjem u Sarvašu nisam bio zadovoljan, jer nisu vođena sa dovoljnim marom, i ne vjerujem da će se o njima moći izdati dobra publikacija, osim smjelim kombinacijama, koje ne odgovaraju faktičkom stanju.*<sup>32</sup>

Danas je dosta teško govoriti o metodi iskopavanja R. R. Schmidta na Sarvašu. Ratne okolnosti svakako su dosta utjecale na tijek iskopavanja i na brojnost (ili manjak) stručne ekipe. Za razliku od iskopavanja Vučedola kada je stručna ekipa bila brojna te uključivala i djelatnike iz Arheološkoga muzeja u Zagrebu, na Sarvašu je bilo puno manje arheologa. Ipak, članovi ekipe Ivan Marović i Hilda Tompak svjedoče o metodičnosti i pedantnom radu toga njemačkoga arheologa.<sup>33</sup>

Sa Schmidtovih iskopavanja objavljeno je vrlo malo nalaza, uglavnom starčevačkih i vučedolskih u tekstovima S. Dimitrijevića. Napominjemo da su isti materijal kao i navedenu stratigrafsku podjelu koristili i drugi pretpovjesničari, npr.: M. Garašanin, N. Tasić, H. Parzinger, Z. Marković i dr.<sup>34</sup>

Prikupljanjem površinskih nalaza nakon II. svjetskog rata dobiveni su još neki zanimljivi podatci u svezi ne samo s vertikalnom, već i s horizontalnom stratigrafijom Sarvaša.<sup>35</sup>

Muzej Slavonije u Osijeku pod vodstvom J. Šimić izveo je manja iskopavanja tijekom 1985. i 1986. godine. Te istraživačke kampanje potvrdile su postojanje obrambenoga latenskog rova te sopotsku, kostolačku, vučedolsku, vinkovačku i belegišku kulturu.<sup>36</sup> Iz tih kampanja obrađeni su nalazi koji pripadaju ranom brončanom dobu, odnosno vinkovačkoj kulturi, pojedinačni nalazi iz razdoblja srednjega brončanog doba te nalazi iz horizonta kasnoga brončanog doba, odnosno grupe Belegiš II.<sup>37</sup>

The excavations by Schmidt are characterized by controversial opinions. Unlike the excavations at Vučedol's Gradac during 1938, that were led systematically, the war excavations of Sarvaš are most of all linked to the fact that he abalienated the excavated materials and heavily violated thereby the law and ethical principles. This opinion is reinforced by a sentence from a letter by V. Hoffiller addressed to the Ministry of Education, that is stored in the Archaeological Museum.

*I was not satisfied with the excavations at Sarvaš as they were not carried out with the due diligence and I do not believe that a good publication will be produced about them, except for daring combinations that do not reflect the actual state of things.*<sup>32</sup>

Today it is very hard to talk about excavation methods of R. R. Schmidt at Sarvaš. War circumstances certainly had a major impact on the flow of excavations and on the number (or lack of) of expert teams. Unlike the excavations at Vučedol when the expert team was numerous and included personnel of the Archaeological Museum of Zagreb, at Sarvaš much less experts were present. However, team members Ivan Marović and Hilda Tompak bear witness of the methodics and precise work of the German archaeologist.<sup>33</sup>

From Schmidt's excavations only few finds have been published, mainly of the Starčevo and Vučedol cultures by S. Dimitrijević, with the hint that the same material and stratigraphy have been reproduced by other authors, like for example M. Garašanin, N. Tasić, H. Parzinger, Z. Marković and others.<sup>34</sup>

By gathering surface finds after World War II more interesting data have been produced in connection with the vertical but also with the horizontal stratigraphy of the Sarvaš.<sup>35</sup>

The Museum of Slavonia, led by J. Šimić carried out smaller excavations during the years 1985 and 1986. These research campaigns confirmed the existence of the defence a Tène trench and the Sopot, Kostolac, Vučedol, Vinkovci and Belegiš cultures.<sup>36</sup> From these campaigns the finds have been analysed belonging to the Early Bronze Age, i.e. to the Vinkovci culture, single finds from the period of the Middle Bronze Age and the finds from the horizon of the Late Bronze Age, i.e. the group Belegiš II.<sup>37</sup>

<sup>32</sup> Arhiv AMZ, 29.10.1945., br. 210/1945.

<sup>33</sup> Grubišić 2002: 119–120.

<sup>34</sup> Garašanin 1951: 79–80; Tasić 1967: 22, 61; Tasić 1970: 26; Tasić 1984: 33–34; Parzinger 1993: 20; Marković 1993: sl. 5:5; Marković 1994: 17, 239 (sl. 7B), 241 (sl. 9A).

<sup>35</sup> Šimić 1991: 7.

<sup>36</sup> Šimić 1986a: 23–24; Šimić 1986b: 37–38; Šimić 1987: 64–65.

<sup>37</sup> Šimić 1991: 10–35; Šimić 1992: 31–48; Šimić 1993: 127–148; Šimić 2000: 122, u ovim je objavama obrađena i građa sa Schmidtovih iskopavanja.

35. S.I.

□ 22  
3.35

*Osijek*



*gotica*

H 6.5 vis  
e 10. H *vis gore*  
e 10 B *medina*  
o 31.5 B  
e 3.5 F. *10*

*Tasa kulam rasteua sannosiva,  
gotova ema. Gore uplofeua. Gore  
drije rane porvine este, Ispud  
nake atabela esta imitupa drije  
rane este. Dno brato ureiuro*

5

Sl. 17 predmetna kartica iz arhiva AMZ-a (predmet se čuva u MSO) | Fig. 17 Card of itmes from the holdings of the Arcaeological Museum of Zagreb - AMZ (the item is stored in the Museum of Slavonia in Osijek - MSO)

## Nalazi u fundusu Arheološkoga muzeja u Zagrebu

U Pretpovijesnoj zbirci Arheološkoga muzeja u Zagrebu čuva se 541 predmet (271 inv. broj) iz nalazišta Sarvaš. Uglavnom je riječ o neolitičkom i eneolitičkom materijalu, koji će biti detaljnije obrađeni u sljedećim poglavljima, ali ima i nalaza iz mlađih razdoblja (brončanoga i mlađega željeznog doba).

Građa je u Muzej počela dolaziti 1900. godine, a najviše građe potječe iz razdoblja između 1906. i 1912. godine.

- **1900.**
  - učitelj Đuro Schäffer daruje Muzeju 7 predmeta; među njima i karbonizirano žito (inv. br. 1504 – 1509)<sup>38</sup>
- **1905.**
  - Josip Brunšmid i učitelj Ivan Klauser skupljaju po površini Vlaselinskoga brijega 36 kom., uglavnom keramičkih ulomaka
  - I. Klauser prodaje Muzeju 2 predmeta (inv. br. 4513 – 4520)
- **1906.**
  - od I. Klausera kupljeno je 30 predmeta (inv. br. 4674 – 4686);
  - od Jakova Wehmanna kupljeno je 78 predmeta (inv. br. 4931 – 4943, 5016 – 5019);
  - J. Wehmann prodaje 7 predmeta s položaja Kučka u Sarvašu (vinograd Josipa Hobeja) (inv. br. 5171 – 5176);
  - župnik Dragutin Bartolović poklonio je Muzeju dva predmeta (inv. br. 5683 – 5684);
  - I. Klauser poklanja Muzeju dva predmeta (inv. br. 5685 – 5686)
- **1907.**
  - posredovanjem I. Klausera kupljeno je 8 predmeta (inv. br. 5741 – 5748);
  - I. Klauser daruje Muzeju dva predmeta (inv. br. 5805 – 5806);
  - Muzej je otkupio 106 predmeta od Josefa Gassenheimera, koje je on skupio u vlastitome vinogradu (inv. br. 5857 – 5898, 17096 – 17097);
  - Viktor Hoffiller skuplja u vinogradu J. Wehmanna 3 ulomka keramike (inv. br. 5996);

## Finds in the holdings of the Archaeological Museum in Zagreb

In the Prehistoric collection of the Archaeological Museum in Zagreb 541 artefacts are stored (271 inventory numbers) from the Sarvaš archaeological site. It is mainly Neolithic and Eneolithic material that will be analysed into more detail in the next chapters. However, there are also finds from later periods (Bronze Age and Late Iron Age).

The materials started coming into the Museum in 1900, whereas the majority of all materials reached the Museum between 1906 and 1912.

- **Year 1900** the teacher Đuro Schäffer donates 7 artefacts to the Museum – among them also carbonized wheat (inv. No. 1504–1509)<sup>38</sup>
- **Year 1905** Josip Brunšmid and the teacher Ivan Klauser collect 36 items on the surface of the *Vlastelinski brijeg*, mainly ceramic fragments. In the same year I. Klauser sells 2 items to the Museum (inv. No. 4513–4520)
- **Year 1906**
  - 30 artefacts were bought from I. Klauser (inv. No. 4674 – 4686);
  - 78 artefacts were bought from Jakov Wehmann (inv. No. 4931 – 4943, 5016 – 5019);
  - J. Wehmann sells 7 artefacts from the location of Kučka at Sarvaš (Josip Hobe's vineyard) (inv. No. 5171 – 5176);
  - the vicar Dragutin Bartolović donated 2 artefacts to the Museum (inv. No. 5683 – 5684);
  - I. Klauser donates 2 artefacts to the Museum (inv. No. 5685 – 5686)
- **Year 1907**
  - Through mediation by I. Klauser 8 artefacts were bought (inv. No. 5741 – 5748);
  - I. Klauser donates 2 artefacts to the Museum (inv. No. 5805 – 5806);
  - The Museum bought off 106 artefacts from Josef Gassenheimer, that he collected in his vineyard (inv. No. 5857 – 5898, 17096 – 17097);
  - Viktor Hoffiller gathered in J. Wehmann's vineyard 3 ceramic fragments (inv. No. 5996);



- **1909.**  
– od J. Gassenheimera kupljen je materijal (86 predmeta) koji je on skupio u vlastitome vinogradu (inv. br. 6169 – 6205);
- **1911.**  
– kupljena je građa (17 predmeta) skupljena u Kühnovu vinogradu (inv. br. 6326 – 6331);  
– Jakov Wehman poklonio je Muzeju 1 predmet (inv. br. 6386);
- **1912.**  
– od J. Gassenheimera kupljena je građa (8 kom.) (inv. br. 6550 – 6553);
- **1936.**  
– kupljen je 1 predmet od J. Gassenheimera; (inv. br. 20373);
- **1948.**  
– dio građe s iskopavanja R. R. Schmidta repatriacijom je došao u Muzej (inv. br. 7845 – 7941, 16931 – 16933, 18956, 20369 – 20372, 20374 – 20387)

U Arhivi Arheološkoga muzeja u Zagrebu čuva se zapisnik (br. 381/1948) u kojem su popisani predmeti repatriacijom dodijeljeni Muzeju: u njemu se navodi 11 sanduka s materijalom, zatim jedan sanduk s rukopisima i fotografijama Schmidtove monografije *Die Burg Vučedol* te kartoteka sarvaškoga materijala (pojedinu karticu čini fotografija svakoga predmeta s upisanim kvadrantom i dubinom, dimenzijama te oznakom mjesta čuvanja: Osijek ili Zagreb, sl.17). Međutim, sumnju u vjerodostojnost popisa izaziva činjenica što je prema njemu u pojedinim sanducima bio samo po jedan predmet, a u jednom sanduku, iako popisanom, nije bio niti jedan predmet. Također je i rukopis monografije danas u osječkom muzeju, što nas navodi na zaključak da je naknadno, nakon podjele još nešto od popisane građe završilo u Osijeku.<sup>39</sup>

- **1909.**  
– 86 artefacts were bought from J. Gassenheimer that he collected in his own vineyard (inv. No. 6169 – 6205);
- **1911.**  
–17 artefacts were bought that were collected in Kühn's vineyard (inv. No. 6326 – 6331);  
– Jakov Wehman donated 1 artefact to the Museum (inv. No. 6386);
- **1912.**  
– 8 artefacts were bought from J. Gassenheimera (inv. No. 6550 – 6553);
- **1936.**  
–1 artefact was bought from J. Gassenheimer (inv. No. 20373);
- **1948.**  
– Part of the excavation material of R.R. Schmidt reached the Museum after repatriation (inv. No. 7845 – 7941, 16931 – 16933, 18956, 20369 – 20372, 20374 – 20387)

In the archives of the Archaeological Museum in Zagreb a record sheet is stored (No. 381/1948) in which all repatriated artefacts are listed: In the list 11 cases with materials are named, one case with manuscripts and photographs from Schmidt's monograph »Die Burg Vučedol« and a card-file of the Sarvaš material (the single card consists of a photograph of each artefact with the data concerning its quadrant and depth, dimensions and the sign of the place of storage Osijek or Zagreb, fig.19). However, there are doubts regarding the authenticity of the list. For instance, according to the list, several boxes contained only one artefact, and there was even one box on the list that contained no artefacts at all. Also the manuscript and the monograph are today in the Osijek museum, which leads us to the conclusion that subsequently, after the division some artefacts additionally ended up in Osijek.<sup>39</sup>

<sup>38</sup> U pismu koje se čuva u Arhivu AMZ-a (br. 75/1900) Đ. Schäffer navodi okolnosti pronalaska: predmete vučedolske kulture (kat. br. 73, 100) pronašao je na 2–3 m relativne dubine, a pšenicu na 4 m, citiramo:...na četiri prsta debeloj i tri metra dugačkoj prostirućoj naslagi.

<sup>39</sup> Gubišić 2002: 130.

## Neolitik

### Starčevačka kultura

Najstariji kulturni sloj na Sarvašu pripada razdoblju mlađega kamenog doba, odnosno ranoga neolitika, koji je obilježen starčevačkom kulturom.

Prvi starčevački nalazi na području Hrvatske potječu iz 1894. s položaja Gimnazije u Vukovaru, no upravo je izbor nalaza iz Vučedola i Sarvaša u monografskom djelu R. R. Schmidta prva, ispravno znanstveno atribuirana objava te kulturne manifestacije.

Starčevačka kultura predstavnik je ranog i srednjeg neolitika, a kao gotova kulturna pojava dolazi na prostor istočne Slavonije. Ona je prva predstavnica neolitika na prostoru kontinentalne Hrvatske. Rasprostirala se od istočnih granica Slavonije pa sve do Bjelovara na zapadu. U kasnoj fazi u njezino je najistočnije područje prodrla vinčanska kultura i potisnula starosjedioce, koji su u traženju novoga prostora selili prema zapadu. Naselja pripadnika starčevačke kulture redovito su bila na povišenim riječnim obalama. Živjeli su u jamskim objektima (zemunice) te rjeđe u nadzemnim objektima.<sup>40</sup>

Danas najpotpunije podatke o organizaciji naselja i o materijalnoj ostavštini te kulture pružaju rezultati iskopavanja s područja Slavenskoga Broda te iz Vinkovaca, gdje su ili zaštitnim ili sustavnim istraživanjima obuhvaćene velike otkopne površine.<sup>41</sup>

Keramika je pečena tzv. oksidacijskim postupkom, tj. uz znatnu cirkulaciju zraka u peći, pa je crvene ili oker boje. Oblikom su to jednostavne zaobljene zdjele, a neke od njih imaju nisku prstenastu nogu.

U dokumentaciji R. R. Schmidta starčevačka je kultura izdvojena i prepoznata kao zasebna kulturna jedinica. On navodi dva sloja: I-a na dubini od 8,20 do 7,40 m i I-b na relativnoj dubini od 7,40 do 4,90 m.<sup>42</sup> Dimitrijević je ustanovio da najviše starčevačkih nalaza potječe iz blokova A i B. U bloku

## The Neolithic

### The Starčevo culture

The oldest cultural layer at Sarvaš belongs to the period of the Late Stone Age, i.e. the Early Neolithic, that is characterized by the Starčevo culture.

The first Starčevo finds on the territory of Croatia date back to 1894 from the location of the *Gimnazija* (High School) in Vukovar. However, the selection of finds from Vučedol and Sarvaš from the monograph by R. R. Schmidt is the first scientifically accepted publication of that cultural event.

The Starčevo culture represents the early and Middle Neolithic whereas as a complete culture it stretches on the territory of eastern Slavonia. It is the first representative of the Neolithic on the territory of Croatia. It spread from the eastern barriers of Slavonia till up to the city of Bjelovar in the West. In its later phase, the territory was penetrated by the Vinča culture that repressed the aboriginals, who in the search of a new location were migrating westwards. The settlements of the Starčevo culture were as a rule on elevated river banks. They lived in pit housing objects (dugouts) and more rarely in surface housing objects.<sup>40</sup>

Today the most complete data about the organisation of the settlement and the material legacy of that culture are offered by the results from the excavations in the area of Slavonski Brod and Vinkovci where large excavation surfaces are covered by either preservation or systematic research work.<sup>41</sup>

The pottery is baked in the so called oxidation procedure, i.e. through a substantial circulation of air in the oven, so that it is red or ochre. In terms of shapes, these are simple, rounded bowls and some of them have a short ring-shaped foot.

In the documentation by R. R. Schmidt the Starčevo culture is separated and recognized as a single cultural unit. He mentions two layers at the depth of 8,20 to 7,40m and I-b at the relative depth of 7,40 to 4,90m.<sup>42</sup> Dimitrijević found out that the majority of Starčevo finds originates from the blocks A and B. In

<sup>40</sup> Dizdar & Krznarić-Škrivanko 2000: 9–10.

<sup>41</sup> Minichreiter 1992a, 29–35 (Zadubravlje, istraženo 6200 m<sup>2</sup>); Krznarić-Škrivanko 1999, 11 (te// Vinkovci, istraženo 11 614 m<sup>2</sup>); Minichreiter 2005: 25–30 (Galovo, istraženo 2200 m<sup>2</sup>).

<sup>42</sup> Schmidt 1945: 129.

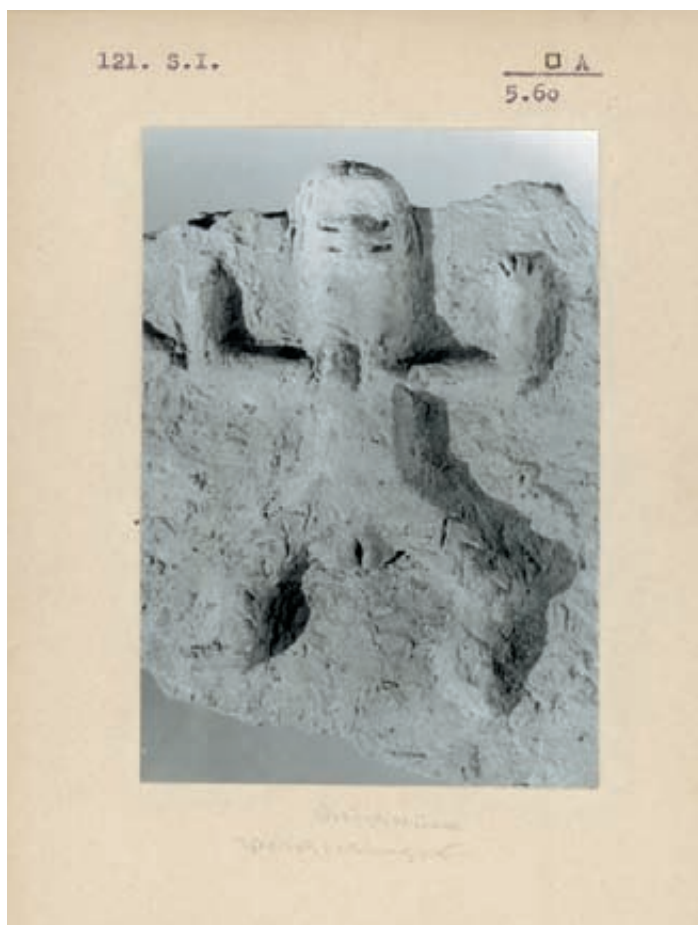

Sl. 18 ulomak keramičke posude ukrašen reljefnim prikazom (predmet se čuva u MSO, foto: predmetna kartica, arhiv AMZ)  
 Fig. 18 A fragment of a ceramic vessel decorated with relief applied imagery (the item is stored in MSO, photograph: Cart of items, holdings AMZ)



Sl. 19 žrtvenik ((predmet se čuva u MSO, foto: predmetna kartica, arhiv AMZ) | Fig. 19 Altar (the item is stored in MSO, photograph: Cart of items, holdings AMZ)

B nalazi potječu iz dubina 5,80–4,80 m, a u bloku A na istim se dubinama (7,30–4,30 m) osim starčevačke javlja i sopotska keramika.<sup>43</sup> Glede organizacije naselja i tipa kuća znamo samo da je riječ o zemunicama, a nikakav detaljniji podatak nije nam poznat.<sup>44</sup>

Objavljeni materijal dosta je skroman – Schmidt je objavio svega šest posuda te 4 motiva izvedena slikanjem.<sup>45</sup> Neki od tih nalaza često su poslije ponovno reproducirani,<sup>46</sup> a u jednoj od prvih objava starčevačke kulture, onoj D. Arandelović Garašanin, sarvaško se naselje često spominje.<sup>47</sup> Najčešće publiciran predmet svakako je ulomak posude s reljefnom aplikacijom ženske figure, koji se čuva u Muzeju Slavonije u Osijeku (sl.18).<sup>48</sup> Ulomak pripada većoj posudi grube fature, a na njoj je prikazan ženski lik s raširenim rukama, savijenim u laktu i okrenutim prema gore (orant). Ulomak je nađen na dubini od 5,60 m. Do danas su u starčevačkim naseljima na tlu Hrvatske otkrivena samo četiri takva prikaza, a osim sarvaškoga jedan potječe iz Slavanskoga Broda te dva iz Vinkovaca.<sup>49</sup>

block B the finds originate from the depths of 5,80–4,80m and in block A at the same depths (7,0–4,30 m) besides the Starčevo also the Sopot pottery is found.<sup>43</sup>

As far as the organisation and the type of housing is concerned, we know that they were dugouts and no further detail is known.<sup>44</sup> The published material is pretty modest – Schmidt published altogether six vessels and four motifs made by painting<sup>45</sup>. Some of these finds were often reproduced later<sup>46</sup>, and in one of the first publications of the Starčevo culture, the D. Arandelović Garašanin one, the Sarvaš settlement is often mentioned.<sup>47</sup> The most often published artefact certainly is a fragment of a vessel with a relief applied female figure stored in the Museum of Slavonia in Osijek (fig. 18).<sup>48</sup> The fragment belongs to a larger vessel roughly manufactured on which a female character is displayed with stretched arms, bent in the elbow and turned upwards (an orant figure). The fragment was found at a depth of 5,60 m. Up to today in the Starčevo settlements on the territory of Croatia only four such outlines have been found, and besides the Sarvaš one is from Slavonski Brod and two from Vinkovci.<sup>49</sup>

Another interesting artefact that stands out among the published material is an altar with a rectangular container, extended

<sup>43</sup> Dimitrijević 1969a: 15.

<sup>44</sup> Schmidt spominje »neolithische siedlung mit grubenhauser«, vidi Schmidt 1945: 129.

<sup>45</sup> Schmidt 1945: sl. 74, 74 A. Posuda na sl. 74:2 ne predstavlja karakterističan starčevački oblik te pripada mlađem razdoblju (nalaz se čuva u MSO). Nalaz na sl. 74:6 pripada sopotskoj kulturi i bit će obrađen u sljedećem poglavlju.

<sup>46</sup> Dimitrijević 1969b: T. 1:2; Dimitrijević 1974: T. IV:6–10; Minichreiter 1992a: 21, 22, T.10, sl. 21:1,8,9; Marković 1994: T.1:4–7.

<sup>47</sup> Arandelović-Garašanin 1954: 8, 16, 18, 25, 45, 133.

<sup>48</sup> Šimić 1995:9, kat. br. 2.1; Težak-Gregl 1998: 72, sl. 6; Minichreiter 2000: sl. 3; ovdje su kao ilustracija uzete samo neke od posljednjih objava.

<sup>49</sup> Minichreiter 2000.

Drugi zanimljiv predmet koji se ističe među objavljenim materijalom jest žrtveni stolić, tj. žrtvenik s četvrtastim recipientom, izvučenim rubom s plastičnim rogolikim protomama na uglovima, postavljenim na četiri zoomorfne noge (sl. 19).<sup>50</sup> Ustanovljeno je da je rekonstrukcija žrtvenika izvedena dosta nespretno te da je recipient oblikom bio bliže kvadratu nego što je izdužen i pravokutan, kako ga je rekonstruirao R. R. Schmidt. Slični žrtvenici potječu iz Zadubravlja, Pepelane, Kaniške Ive i Cerničke Šagovine.<sup>51</sup>

Keramički starčevački materijal iz Sarvaša (na temelju svih objavljenih primjeraka) može se podijeliti na grubo i fino posuđe.<sup>52</sup> Od posuda grube fature uglavnom su zastupljeni lonci S-profilacije ili s cilindričnim vratom. Ukrašeni su kaneliranim barbotinom, plastičnim naljepcima ili plastičnim trakama s otiscima prsta. Zastupljena je i impresso tehnika ukrašavanja kao i štipanje vrhovima prstiju. Fina keramika ukrašena je bijelim i tamnim slikanjem pravocrtnih motiva.

U fundusu AMZ-a osim već dviju objavljenih posuda (kat. br. 1–2), svega smo još četiri predmeta mogli donekle sa sigurnošću pripisati nosiocima starčevačke kulture.<sup>53</sup> Uglavnom je riječ o posudama grube fature te nije zabilježen ni jedan primjerak fine slikane keramike. Izdvojeni materijal možemo podijeliti u dvije kategorije: lonci (kat. br. 1–3) i posude na nozi (kat. br. 4–6).

Od tipova lonaca zastupljeni su: lonac zaobljena tijela, cilindrična vrata i prstenasta dna (kat. br. 1), zatim lonac S-profilacije, također prstenasta dna (kat. br. 2) te zaobljen lonac blago uvučena ruba i ravna dna (kat. br. 3). Od ukraša zastupljena je samo plastična modelacija: posuda pod kat. br. 1 ima plastične naljepke po čitavoj površini posude i plastične aplikacije, a ona pod kat. br. 2 ima ušice na najširem dijelu posude.

Među materijalom ističu se dvije male posudice na nozi (kat. br. 4 i 5). Noge su cilindrične, pune, ali se sasvim pri dnu račvaju u pet (kat. br. 4, sl. 20) i deset krakova (kat. br. 5) te podsjećaju na životinjske šape. Slične nalazimo među materijalom više neolitičkih kultura, npr. iz Okolišta, naselja butmirske kulture,<sup>54</sup> Vinče,<sup>55</sup> te iz mađarskih lokaliteta koji pripadaju körös ili sopotskoj kulturi: Bicske-Galagonyás,<sup>56</sup> Endröd-Szujókereszt,<sup>57</sup> Balatonmagyaród Kápolnapuszta.<sup>58</sup>

Među materijalom je ustanovljena i trodijelna noga posude. Slične primjerke nogu posuda koje se račvaju u tri dijela (kat. br. 5) pronalazimo na nalazištu Donja Branjevina u Vojvodini, gdje su pronađeni različiti oblici četverodijelnih ili trodijelnih dna žrtvenika.<sup>59</sup>

rim with relief applied horn-shaped protomes at the edges, placed on four zoomorphic feet (fig. 19).<sup>50</sup> The altar reconstruction was made pretty uncouthly so that the container is closer to a square than it is elongated and rectangular, as reconstructed by R. R. Schmidt. Similar altars come from Zadubravlje, Papelane, Kaniška Iva and Cernička Šagovina.<sup>51</sup>

The pottery from Sarvaš (on the basis of the published exemplars) can be divided into coarse and fine ware.<sup>52</sup> Among the coarsely manufactured vessels mainly pots are represented with either an S-profilation or a cylindrical neck. They are decorated by fluted barbotine, relief applied plasters or relief applied bands with fingerprints. Also the impressing embellishing technique is present as well as pinching with finger tips. Fine pottery is decorated with white and dark painting of straight line motifs.

In the holdings of the AMZ apart from two published vessels (cat. No. 1–2) only four items could be identified almost certainly as belonging the bearers of the Starčevo culture.<sup>53</sup> These are mainly vessels coarsely manufactured and no item is found of fine, painted pottery. The selected material can be divided into two groups: pots (cat. No. 1–3) and vessels on a foot (cat. No. 4–6).

Among the pots following types are represented: a pot with a rounded body, cylindrical neck and a ring-shaped base (cat. No. 1), an S-profiled pot also with a ring-shaped base (cat. No. 2) and a rounded pot with a gently indent rim and a flat base (cat. No. 3). Among the decorations only relief applications are present: vessel cat. No. 1 has relief applied plasters across its whole length and relief applications and cat. No. 2 has lugs at the broadest section of the vessel.

Among the material two small vessels on a foot stand out (cat. No. 4 and 5). The feet are cylindrical, full and branch at the end into five (cat. No. 4, fig. 20) and ten tentacles (cat. No. 5) and are reminiscent of animals' paws. Similar items are found among numerous other Neolithic cultures from Okolište, settlements of the Butmir culture,<sup>54</sup> Vinča,<sup>55</sup> and from the Hungarian finding sites that belong to the Körös or Sopot culture: Bicske-Galagonyás,<sup>56</sup> Endröd-Szujókereszt,<sup>57</sup> Balatonmagyaród Kápolnapuszta.<sup>58</sup>

Among the material also a tripartite vessel foot was identified. Similar vessel foot exemplars that branch into three parts (cat. No. 3) are found at the finding site of Donja Branjevina in Vojvodina, where different shapes of three-partite and four-partite altar bases were found.<sup>59</sup>

<sup>50</sup> Schmidt 1945: T.74:3.

<sup>51</sup> Minichreiter 1992b: 10; Težak-Gregl 2003. Ovdje moramo istaknuti i mišljenje nekih autora po kojima ovaj oblik možda pripada vučedolskoj kulturi, vidi: Miličević Bradač 2005: 191, fig. 12.

<sup>52</sup> U Katalogu predmeta za grubu keramiku koristili smo termin *slabo zaglađena i neravna površina*, dok je fina keramika stupnjavana kao: *glatka-mat površina* (zaglađena, bez sjaja), *djelomično uglačana* (vidljivi su tragovi glačanja) i *uglačana površina* (preuzeto iz Vrdoljak 1994: 14).

<sup>53</sup> Neki su naime oblici karakteristični za čitavo razdoblje neolitika, odnosno javljaju se u oblikovanju nekoliko neolitičkih kultura. Kako ne raspolažemo stratigrafskim kontekstom predmete smo po fakturi pripisali starčevačkoj kulturi, iako ne isključujemo mogućnost njihova atribuiranja ranoj sopotskoj kulturi (to se posebice odnosi na predmete pod kat. br. 4 i 5).

<sup>54</sup> Perić 1995: T XXXV:5.

<sup>55</sup> Vasić 1936: T. XXIII:55.

<sup>56</sup> Makkay et al. 1996: sl. 18:11.

<sup>57</sup> Makkay 1987: sl. 2:1–7,10.

<sup>58</sup> Barna 2001: T. 1:3.

<sup>59</sup> Karmanski 2005: T. LXX, LXXV:2.



Sl. 20 kupa na nozi, kat. br. 4 I  
Fig. 20 Chalice on foot, cat. No. 4

S. Dimitrijević isprva je nalaze iz Sarvaša datirao u spiraloid A stupanj starčevačke kulture.<sup>60</sup> Međutim, u kasnijim objavama nalaze stavlja u girlandoid stupanj starčevačke kulture, što je mišljenje i Z. Markovića.<sup>61</sup> Po K. Minichreiter nalazi iz Sarvaša pripadaju linear B i girlandoid stupnju.<sup>62</sup>

### Sopotska kultura

Sarvaški plato nakon nosilaca starčevačke naseljavaju pripadnici sopotske kulture. U vrijeme Schmidtova iskopavanja Sarvaša sopotska kultura još nije bila izdvojena i prepoznata kao zasebna kulturna pojava, iako Schmidt izdvaja sloj II na dubini od 4,90 do 3,60 (4,00) m te ga atribuirao kao neolitičko naselje.<sup>63</sup> Za isti taj sloj Miložić poslije uvodi termin slavonsko-srijemska kultura.<sup>64</sup> Dimitrijević isprva sopotski horizont na Sarvašu određuje do dubine od 5,50 m te ga stavlja u I-A i I-B stupanj.<sup>65</sup> U kasnijim objavama sopotski sloj određuje od 4,50 do 6,00 m i dublje, odnosno do zdravice te pretpostavlja dva sopotska horizonta, koje smješta u I-B i II stupanj sopotske kulture.<sup>66</sup>

Sopotska kultura predstavnik je klasične zemljoradničke neolitičke privrede koja se razvila na temeljima kasne starčevačke kulture. Rasprostirala se u većem dijelu sjeverne Hrvatske tijekom srednjega i kasnoga neolitika. Nositelji

S. Dimitrijević dated the Sarvaš finds in the Spiraloid A phase of the Starčevo culture.<sup>60</sup> However, in the latter publications he puts the finds into the Girlandoid phase of the Starčevo culture, which corresponds to Z. Marković's<sup>61</sup> opinion. According to K. Minichreiter the Sarvaš finds belong to the Linear B and Girlandoid phase.<sup>62</sup>

### The Sopot culture

After the bearers of the Starčevo culture, the Sarvaš area was inhabited by the bearers of the Sopot culture. At the time of the Sarvaš excavations by Schmidt, the Sopot culture was still not separated and recognized as a single cultural appearance, in spite of the fact that Schmidt singled out the layer II at the depth of 4,90 to 3,60 (4,00) m and classified it as Neolithic settlement.<sup>63</sup> For the same layer Miložić uses the term Slavonian-Srijem culture.<sup>64</sup> Dimitrijević determines firstly the Sopot horizon at Sarvaš till the depth of 5,50 m and classifies it into the phases I-A and I-B.<sup>65</sup> In later publications the Sopot layer is classified from 4,50 to 6,00 m and deeper, i.e. up to the virgin soil and moves two Sopot horizons, which he locates into the phase I-B and II of the Sopot culture.<sup>66</sup>

The Sopot culture represents the classical Neolithic agriculture that develops on the basis of the late Starčevo culture. It

<sup>60</sup> Dimitrijević 1968: 27.

<sup>61</sup> Dimitrijević 1974: T. IV:6–10; Dimitrijević 1979a: 246; Marković 1994: 71.

<sup>62</sup> Minichreiter 1992a: 22; Minichreiter 1997: 21–22.

<sup>63</sup> Schmidt 1945: 129.

<sup>64</sup> Miložić 1949: 82.

<sup>65</sup> Dimitrijević 1968: 27.

<sup>66</sup> Dimitrijević 1969b: 52; Dimitrijević 1979a: 265.

sopotske kulture živjeli su u naseljima smještenim u nizin-  
skim, često močvarnim predjelima uvijek u neposrednoj bli-  
zini rijeka ili potoka. Naselja su bila zbijenoga seoskog tipa s  
nadzemnim kućama pravokutnog oblika i obično s jednom  
ili dvije prostorije.<sup>67</sup> U ranoj fazi sopotske kulture ipak je  
zabilježeno korištenje zemuničkih objekata za stanovanje: na  
Ervenici u Vinkovcima ustanovljeno je raštrkano naselje otvo-  
renoga tipa, što se nadovezuje na starčevačku tradiciju.<sup>68</sup>

Od građe iz Sarvaša koja se čuva u Arheološkom muzeju u  
Zagrebu samo jedan predmet potječe iz Schmidtovih isko-  
pavanja (kat. br. 15), a ostali je materijal u Muzej dospio na  
početku 20. stoljeća.

Uvidom u kartoteku sarvaške građe koja se čuva u  
Arheološkome muzeju u Zagrebu možemo zaključiti da  
najviše sopotskih nalaza, kao i starčevačkih, potječe iz bloka  
A. u navedenom bloku na dubini od 4,50 m pronađeno je 12  
kruškolikih keramičkih utega, najvjerojatnije od tkalačkoga  
stana.<sup>69</sup>

Prije objavljenih sopotskih nalaza vrlo je malo. Tri predmeta  
– dvije posudice grube izradbe, odnosno dječje igračke (kat.  
br. 14–15) točno su atribuirane sopotskoj kulturi,<sup>70</sup> dok je  
Hoffiller objavio posudicu s izljevkom, međutim bez kultur-  
ne atribucije (kat. br. 13).<sup>71</sup> Za takav tip posuda u literaturi  
je zastupljeno mišljenje da su rabljene pri hranjenju male  
djece.<sup>72</sup>

Osim tih triju ulomaka iz građe smo izdvojili dvije noge posu-  
da, vjerojatno od kupa. Jedna pripada tipu zvonolikih nogu  
(kat. br. 11), a druga je puna, cilindrična, s okruglom rupom  
(kat. br. 12). Posude na nozi s rupom pojavljuju se u sopot-  
skoj kulturi u II stupnju te su karakteristične i u sljedećoj  
fazi.<sup>73</sup>

Od ostalih oblika zastupljen je tip lončića (ili zdjelice) blago  
bikonična tijela i izvijena vrata (kat. br. 7–8),<sup>74</sup> zatim tip zaobljena  
lončića s ravnim vratom s ušicama na trbuhu (kat. br. 9) te lončić S-profilirana  
tijela, također s ušicom na trbuhu (kat. br. 10). Nalazi zaobljenog i S-profiliranog  
lončića s ušicama na trbuhu (kat. br. 9–10) koji su po Dimitrijeviću  
karakteristični oblici za III stupanj sopotske kulture,<sup>75</sup> pružaju  
nam osnovu za pretpostavku nešto duljeg trajanja sopotsko-  
ga naselja na Sarvašu od datacije S. Dimitrijevića.

stretched across a larger part of northern Croatia throughout  
the Middle and Late Neolithic. Bearers of the Sopot culture lived  
in settlements located in lowland, often swampy areas always  
in the vicinity of rivers and streams. The settlements were of a  
thick peasant type with above-ground houses of a rectangular  
shape and often with one or two rooms.<sup>67</sup> In the early phase  
of the Sopot culture, the use of pit dwellings was registered: at  
Ervenica in Vinkovci a scattered settlement of an open type was  
determined that continues the Starčevo tradition.<sup>68</sup>

From the Sarvaš material, stored in the Archaeological Museum  
in Zagreb, only one artefact is from the excavations by Schmidt  
(cat. No. 15) whereas the remaining materials reached the  
Museum at the beginning of the 20th century. With an  
insight into the card files of the Sarvaš materials stored in the  
Archaeological Museum in Zagreb, we can conclude that most  
of the Sopot and Starčevo finds come from the block A. At the  
depth of 4,50 m in this block 12 pear-shaped ceramic weights  
were found, most likely from a waver's flat.<sup>69</sup>

There are only few previous publications of Sopot finds. Three  
artefacts – two small vessels coarsely made, i. e. children's toys  
(cat. No. 14–15) are correctly attributed to the Sopot culture,<sup>70</sup>  
whereas Hoffiller published the small vessel with a drain, how-  
ever with no cultural attribution (cat. No 13).<sup>71</sup> For such a vessel  
type in the literature the opinion is widely accepted that these  
vessels were used to feed small children.<sup>72</sup>

Besides these three fragments, from the materials we selected  
two vessel feet, probably of a chalice. One belongs to the type  
of bell-shaped foot (cat. No 11) and the second is full, cylindrical,  
with a circular hole (cat. No. 12). The vessels on a foot with a  
hole appear in the Sopot culture in the phase II and are typical  
also of the subsequent phase.<sup>73</sup>

Among the remaining shapes are represented the type of a  
small pot (or bowl) with a gently biconical body and an everted  
neck (cat. No. 7–8)<sup>74</sup>, the type of a rounded small pot with a  
flat neck and lugs at the belly (cat. No 9) and a small S-profiled  
pot with a flat neck and lugs at the belly (cat. No 10). The finds  
of the rounded, S-profiled small pot with lugs at the belly (cat.  
No. 9–10) – according to Dimitrijević typical shapes of the Sopot  
culture phase III<sup>75</sup> – are the basis for the assumption that the  
Sopot settlement at Sarvaš lasted longer than it was believed  
earlier by Dimitrijević.

<sup>67</sup> Dimitrijević 1979a: 270–273.

<sup>68</sup> Krznarić-Škrivanko 1997.

<sup>69</sup> Navedeni nalazi ne čuvaju se u AMZ-u, već smo podatak preuzeli iz ranije spominjane kartoteke. Za nalaze utega unutar sopotskih objekata vidi: Krznarić-Škrivanko 2003: 65.

<sup>70</sup> Balen-Letunić 1982: 71.

<sup>71</sup> Hoffiller 1938: T.2:1.

<sup>72</sup> Eibner 1973; Balen-Letunić 1982: 72.

<sup>73</sup> Dimitrijević 1968: 42–43.

<sup>74</sup> primjerak sličan bikoničnom lončiću pod. kat. br. 7 je iz Otoka, vidi: Dimitrijević 1968: T. V:7.

<sup>75</sup> Dimitrijević 1968: sl. 8:22–23.

## Eneolitik

### Badenska kultura

Badenska kultura prva je eneolitička kultura koja naseljava Sarvaš. U Sarvašu, isto kao i na Vinči, Hrtkovcima i Bapskoj badensko preslojavanje slijedi kasnoneolitičke stratume.

Po Schmidt u badenski se horizont (sloj III) nalazi između 3,00 i 3,60 m, ali badensku keramiku pronalazi i u sloju II (3,60–4,90 m).<sup>76</sup> Ovaj autor začetnik je ideje, koja je dosta brzo odbačena kao neispravna, o autohtonom podrijetlu badenske kulture i to upravo na osnovi nalaza iz Bapske i Sarvaša, u kojem u sloju II vidi protobadensku kulturu.

Badenska kultura, prva je indoeuropska populacija koja je došla u ove krajeve. Nomadski način života, pojava kola i konja učinili su je vrlo mobilnom, tako da je postignuto jedinstvo stila na velikom području koje se proteže od Karpata. Badenska kultura pripada izrazito stočarskoj i najranijoj indoeuropskoj populaciji u središnjoj Europi, koja je prodrla u područje istočne Slavonije i Srijema te razarala naselja kasne vinčanske i sopotske kulture.

Po Dimitrijeviću dva su badenska građevinska horizonta na Sarvašu: stariji na 4,00–5,50 m te mlađi na 3,20–4,00 m.<sup>77</sup> Navodi također da se na sačuvanoj dokumentaciji može razabrati da se kućni podovi unutar badenskoga sloja protežu u dva nivoa, a negdje i u tri.<sup>78</sup> Dimitrijević oba badenska horizonta stavlja u stupanj B-2.<sup>79</sup>

Postojanje nadzemnih kuća, među kojima posebno ističe apsidalnu kuću, u badenskom sloju, navodi i Schmidt. Dvije apsidalne kuće ustanovljene su i na vučedolskom Gradcu, a Schmidt ih je također interpretirao kao badenske. Međutim moramo naglasiti, iako je u literaturi već dosta o tome raspravljano, da za Schmidtovih istraživanja na Vučedolu i Sarvašu kostolačka kultura nije bila izdvojena kao zasebna kulturna pojava, nego su kostolački nalazi pripisani starijoj, badenskoj kulturi. Tako na oba lokaliteta imamo po dva badenska sloja, a vjerojatnije je da je jedan, onaj gornji, zapravo kostolački. Revizijom građe s vučedolskoga Gradca

## The Eneolithic

### The Baden culture

The Baden culture is the first Eneolithic culture that inhabited the Sarvaš. At Sarvaš, like at Vinča, Hrtkovci and Bapska the relayering follows late Neolithic strata.

According to Schmidt the Baden horizon (layer III) is between 3,00 and 3,60 m, but Baden pottery can be found also in the layer II (3,60–4,90 m).<sup>76</sup> He is the initiator of the idea, that has soon been rejected as incorrect, about the autochthonous origin of the Baden culture based on the finds from Bapska and Sarvaš, where he saw the proto-Baden culture in the layer II.

The Baden culture is the first Indo-European population that reached these regions. The nomadic life style, the appearance of cart and horses made it very mobile so that the unity of style was reached that stretches across the Carpathian. The Baden culture belongs to a distinctively cattle-breeding and to the earliest Indo-European population in central Europe, that penetrated the territory of eastern Slavonia and Srijem ravaging the settlements of the Vinča and Sopot cultures.

According to Dimitrijević there are two Baden horizons at Sarvaš, an older one at 4,00–5,50 m, and a younger one at 3,20–4,00 m.<sup>77</sup> He also stated that in the preserved documentation the fact can be discerned that home floors in the Baden layer are on two levels, and somewhere even three.<sup>78</sup> Dimitrijević categorizes both Baden horizons into phase B-2.<sup>79</sup>

Also Schmidt mentions the existence of houses above the surface, among which he points out the apsidal house, in the Baden layer. Two apsidal houses were identified also on the Vučedol Gradac, and Schmidt also interpreted them as being from the Baden layer. However, it must be pointed out that, although in the literature a lot has been debated about this issue, at the time of Schmidt's excavations at Vučedol and Sarvaš the Kostolac culture was not singled out as an independent cultural appearance, but the Kostolac finds were attributed to the older Baden culture. On both finding sites two Baden layers are represented and most likely one of them, the upper one, is actually the Kostolac layer.

<sup>76</sup> Schmidt 1945: 129, 141; Milošević 1949: 82.

<sup>77</sup> Dimitrijević 1968: 27.

<sup>78</sup> Dimitrijević 1979b: 199.

<sup>79</sup> Dimitrijević 1979b: 212.

potvrđeno je postojanje jakoga kostolačkog sloja, što se potvrđuje i daljim istraživanjima na vučedolskom kompleksu, isto kao i pripadnost apsidalnih kuća kostolačkoj kulturi.<sup>80</sup> Ipak, situacija na Sarvašu nije posve jasna; slojevi su uleknuti, a i dokumentacija je manjkava. Primjer Vučedola, gdje je unutar badenskog sloja potvrđeno postojanje nadzemnih objekata upozorava da se ipak ne smije posve isključiti postojanje nadzemnih objekata u sklopu badenske kulture na Sarvašu.<sup>81</sup>

Iako je Sarvaš kao badenski lokalitet često citiran u znanstvenoj literaturi,<sup>82</sup> vrlo je malo građe objavljivano u literaturi.<sup>83</sup>

Od oblika koji se nalaze u fundusu AMZ-a zastupljeno je nekoliko tipova: zdjela, lonac, šalica i izdužena posuda ili vretenasta amfora.

By reviewing the material from Vučedol's Gradac the existence of a strong Kostolac layer was confirmed which is also confirmed by the further research at the Vučedol complex, as well as the belonging of the apsidal houses to the Kostolac culture.<sup>80</sup> However, the situation at Sarvaš is not completely clear; the layers are swaled and the documentation is incomplete. The example of Vučedol, where the existence of objects above the surface was confirmed within the Baden layer, warns us that the existence of over-ground objects in the Baden culture at Sarvaš cannot be completely excluded.<sup>81</sup>

Although the Sarvaš is often cited in the scientific literature as a Baden finding site,<sup>82</sup> very few materials have been published in the literature.<sup>83</sup>

Among the shapes that are in the holdings of the Archaeological Museum in Zagreb few types are represented: bowl, pot, cup and elongated vessel or spindle amphora.

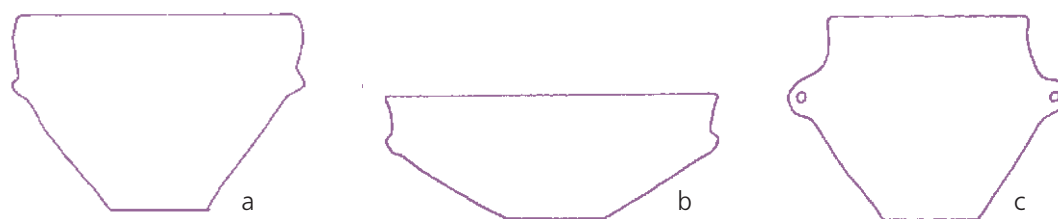

Sl. 21 tipovi zdjela | Fig. 21 Types of bowls

#### Zdjele:

Ustanovljena su tri tipa zdjela:

1. zaobljena duboka zdjela (kat. br. 16, sl.21a)
2. zdjela S-profilirana tijela. Isti tip posude se poslije nastavlja i u kostolačkoj kulturi. (kat. br. 17–18, sl.21b)
3. duboka zdjela izvučena vrata s ručkama na trбуhu (kat. br. 19, sl.21c)

#### Šalice:

1. šalica blage S-profilacije s trakastom ručkom sedlaste profilacije, (kat. br. 21)
2. šalica izdužena vrata i spljoštena recipijenta s trakastom ručkom (kat. br. 22–26, sl.22)

#### Izdužene posude:

U literaturi im je dat naziv vretenaste amfore ili *Fischbutte*. Naši primjerci imaju kratak vrat (kat. br. 27–28, sl.23).

#### Lonci:

Među materijalom u AMZ-u čuva se samo jedan ulomak koji smo pripisali tipu lonaca, odnosno lončića, i to zaobljena tijela (kat. br. 20).

Među građom iz Sarvaša najzastupljeniji tip su zdjele i šalice. Ukrašenost na posudama karakterističan je za badensku kulturu: kanelure, urezi i žigosanje. Zdjele su ukrašene ubadanjem ili žigosanjem okruglim predmetom te urezivanjem. Ukrašeno je rame i donji dio posude. Šalice i izdužene posude ukrašene su kaneliranjem i plastičnim modeliranjem, odnosno

#### Bowls:

Three types of bowls have been identified:

1. A rounded deep bowl (cat. No. 16, fig.21a)
2. A bowl with an S-profiled body. The same kind of vessel continues also in the Kostolac culture. (cat. No. 17–18, fig.21b)
3. A deep bowl with an extended neck and handles at the belly (cat. No. 19, fig.21c)

#### Cups:

1. A cup with a gentle S-profile, a band shaped handle and a saddle shaped profile (cat. No. 21)
2. A cup with an elongated neck and flattened container with band shaped handle (cat. No. 22–26, fig.22)

#### Elongated vessels:

In the literature they are referred to as spindle amphorae or *Fischbutte*. Our exemplars have a short neck (cat. No. 27–28, fig.23).

#### Pots:

Among the materials in the Archaeological Museum in Zagreb only one fragment is stored that we attributed to the pot type, i.e. small pot, and that is the type with a rounded body (cat. No. 20).

In the materials from Sarvaš the most represented type are bowls and cups. The ornaments on vessels are typical of the Baden culture: flutes, incision and impressing. Bowls are decorated by stabbing or impressing with a circular item and by incision. The

<sup>80</sup> Tasić 1979: 249; Nikolić 2000: 42–43; Balen 2002b: 44.

<sup>81</sup> Balen 2004: 66.

<sup>82</sup> Na karti rasprostiranja badenske kulture stavlja ga već Banner 1956: 136.





Sl. 22 šalica, kat. br. 22 | Fig. 22 Cup, cat. No. 22



**Sl. 23** posuda izduljena oblika, kat. br. 27 | **Fig. 23** Vessel with an elongated shape, cat. No. 27

plastičnim rebrima. Lončić ima prepoznatljiv motiv riblje kosti izveden urezivanjem.

Najveći dio materijala karakterističan je za B-2 stupanj badenske kulture: tip šalice cilindrična vrata i niska trbuha, *fischbutte* s kratkim vratom i S-profilirane zdjele.<sup>84</sup> Ipak, dio materijala pokazuje nešto drugačije odlike – šalice pod kat. br. 21 tipična je za starije stupnjeve, odnosno za A-1 ili Boleráz stupanj badenske kulture po S. Dimitrijeviću.<sup>85</sup> Suprotno Dimitrijevićevu mišljenju, Boleráz neki autori smatraju zasebnom kulturom te sastavnim dijelom Cernavodă – Boleráz kulturnoga horizonta,<sup>86</sup> a među naselja na kojima je odvojen taj horizont neki navode i Vučedol.<sup>87</sup> Prepoznatljivi Boleráz oblici ustanovljeni su na Gomolavi, Gradini na Bosutu, da samo spomenemo neke,<sup>88</sup> gdje su povezani s osnivačkom fazom naselja.

Bez obzira na to čije mišljenje zastupamo, evidentno je da se i na Sarvašu možda mora računati s jednom starijom fazom naseljavanja u razdoblju eneolitika od one koja se pojavljuje u literaturi (klasična faza badenske kulture).

## Kostolačka kultura

Nejasno je iz kojega sloja potječu kostolački nalazi iz Schmitovih istraživanja Sarvaša,<sup>89</sup> jer je kostolačka kultura kao zasebna kultura izdvojena nešto kasnije.

V. Miložić 1943. godine prilikom objave keramike iz Šuplje Stene upozorava na odlike jedne nove kulturne pojave,<sup>90</sup> a nekoliko godina kasnije, 1953. objavom materijala koji se čuva u Marburgu V. Miložić imenuje i definira kostolačku kulturu, za koju kaže da je istodobna s kasnom badenskom i ranom vučedolskom kulturom te da ima jake veze s Coqofeni kulturom. Ime joj daje po nalazištu Kostolac, a kao njezinu osnovnu značajku navodi zdjele i *Furchenstich* tehniku ornamentiranja.<sup>91</sup>

Kostolačka kultura razvila se u istočnoj Slavoniji potkraj badenske kulture. Za razliku od badenske populacije, koja je uglavnom živjela u poluukopanim jamskim objektima, njezini su nositelji gradili solidne, čvrste nadzemne objekte. Ovu kulturu stilski obilježava način ukrašavanja – brazdasto urezivanje i ubadanje te šalice s visokom trakastom ručkom koja nadvisuje rub.

Kostolački sloj na Sarvašu mogao bi zapravo biti Dimitrijevićev mlađi badenski građevinski sloj, odnosno sloj na dubini od 4,00 do 3,20 m.<sup>92</sup> O »jačini« kostolačkoga sloja na Sarvašu svjedoči i mnoštvo nalaza skupljenih prije 1942. godine, koje je djelomično objavio i V. Hoffiller.<sup>93</sup>

shoulder and the lower section of vessels are decorated. Cups and elongated vessels are decorated by fluting and relief modelling, i.e. relief applied ribs. Small pots have the recognizable »fish bone« motif made by incision.

The largest part of materials is typical of the phase B-2 of the Baden culture: cup type with cylindrical neck and low belly, fishbutts with short neck and S-profiled bowls.<sup>84</sup> However, part of the material displays somehow different features-the cup from the catalogue number 21 is typical of the older phases, i.e. A-1 or Boleráz phase of Baden culture according to Dimitrijević.<sup>85</sup> Opposite to Dimitrijević's opinion, some authors consider Boleráz a distinct culture and constitutive part of the Cernavodă – Boleráz cultural horizon,<sup>86</sup> and among the settlements where this horizon has been identified some authors list also Vučedol.<sup>87</sup> The recognizable Boleráz shapes have been identified at Gomolava, Gradina at Bosut, just to name a few,<sup>88</sup> where they are connected with the founding phase of the settlement.

Regardless of the fact whose point of view we endorse, it is evident that also at Sarvaš maybe we have to consider one older phase of settlement in the period of the Eneolithic from the one that appears in the literature (the classical phase of the Baden culture).

## The Kostolac culture

It is still unclear from which layer of Schmidt's excavations at Sarvaš<sup>89</sup> the Kostolac finds actually originate, since the Kostolac culture was separated as a single culture sometime later.

In 1943 V. Miložić when publishing the pottery from Šuplja Stena points out the features of the existence of a new culture,<sup>90</sup> and few years later, in 1953 by publishing the materials stored in Marburg V. Miložić names and defines the Kostolac culture. He states that it is concurrent with the late Baden and early Vučedol culture and that it has strong links to the Coqofeni culture. He names it after the finding site of Kostolac, and as its basic trait he lists bowls and the *Furchenstich* decoration technique.<sup>91</sup>

The Kostolac culture developed in eastern Slavonia towards the end of the Baden culture. In opposition to the Baden population, that basically lived in semi-dugged pit objects, the bearers of the Kostolac culture built solid, stable object on the surface. Typical of this culture is the decoration method – grooved incision and stabbing, cups with a high band-shaped handle that tops the rim.

The Kostolac layer at Sarvaš could actually be Dimitrijević's late Baden building layer, i.e. the layer at the depth of 4,00 to 3,20

<sup>83</sup> Dimitrijević 1979b: T. XXII:8, T. XXIII:9; Marković 1994: T. 28:4–5; Težak-Gregl 1998: sl. 43, 45. U literaturi je objavljena još jedna zdjela (Dimitrijević 1979b: T. XXIII:10; Marković 1994: T. 29:6), međutim riječ je o nalazu s Vučedola, također sa Schmidtova iskopavanja (vidi Schmidt 1945: T. 23:6). Hoffiller je također objavio nekoliko predmeta, ali ih nije atribuirao u badensku kulturu. Iz Muzeja Slavonije u Osijeku objavljena je jedna zdjela badenske kulture sa Schmidtovih istraživanja (vidi: Šimić 1995: kat. br. 4.9, bez fotografije).

<sup>84</sup> Dimitrijević 1979b: 214.

<sup>85</sup> Dimitrijević 1979b: 206.

<sup>86</sup> Tasić 1984: 31–32; Tasić 2001; Garašanin 2001.

<sup>87</sup> Tasić 2001: 344–345.

<sup>88</sup> Petrović & Jovanović 2002: 60, 64–69.

<sup>89</sup> Schmidt 1945: 127–131, 184–185.

<sup>90</sup> Miložić 1943: 41–54.

<sup>91</sup> Miložić 1953: 151–157.

<sup>92</sup> Dimitrijević 1968: 26–27.

<sup>93</sup> Hoffiller 1938: T. 9.

U prethodnom poglavlju osvrnuli smo se na problem apsidalne kuće koju je Schmidt datirao u badensku kulturu. Kao i na Vučedolu, on i na Sarvašu navodi postojanje apsidalne kuće koju datira u badensku kulturu. Revizijom građe na Vučedolu uspjeti smo dokazati već i starije navode nekih autora o pripadnosti vučedolskih apsidalnih kuća kostolačkoj kulturi, ali bez atribuirane keramičke građe to je za Sarvaš nemoguće tvrditi.<sup>94</sup>

Iz materijala smo izdvojili tri karakteristična oblika: zdjelu, šalicu i čašu. Repertoar tipova posuda u kostolačkoj kulturi i na drugim je nalazištima vrlo oskudan. Tome je djelomičan razlog simplifikacija u tipovima, koja je dovela do smanjenja broja oblika, tako da se osim oblika koje smo izdvojili iz naše građe uobičajeno još pojavljuje tip lonca zaobljena ili S-profilirana tijela često i s ručkama na trbuhu ili vratu, koje se u literaturi nazivaju amforama.<sup>95</sup>

### Zdjele:

Zdjele su uistinu zastupljene s najvećim brojem primjeraka te nam i to potvrđuje postavku da je osnovna odlika kostolačke kulture zdjela. Zastupljena su četiri osnovna oblika zdjela:

1. kalotaste zdjele (kat. br. 29–37, sl. 24.1a-c)
2. zdjele zaobljenog tijela (kat. br. 38, sl. 24.2a)
3. zdjele izvučenog vrata (kat. br. 39–42, sl. 24.3a-d)
4. zdjele S-profilacije (kat. br. 43, sl. 24.4a).

### Kalotaste zdjele

Donji dio je sasvim zaobljen, tako da je nemoguće reći gdje dno počinje, a gdje završava. Neki primjerci imaju izraženu udubinu na dnu (*omphalos*). Taj tip zdjela u literaturi se naziva kalotastim.<sup>96</sup> Predstavljaju najtipičniji oblik posude unutar kostolačke kulture prisutan na gotovo svim kostolačkim nalazištima. Pod utjecajem kostolačke kulture pojavljuje se i u ranoj fazi vučedolske kulture.<sup>97</sup> Na osnovi ovdje obrađene građe izdvojene su tri varijante toga tipa.<sup>98</sup>

m.<sup>92</sup> The numerous finds gathered before 1942, that were partly published by V. Hoffiller,<sup>93</sup> bear witness about the »power« of the Kostolac layer at Sarvaš.

In the previous chapter we considered the issue of the apsidal house that was dated by Schmidt to the Baden culture. Likewise in Vučedol he states also at Sarvaš the existence of an apsidal house belonging to the Baden culture. By reviewing the Vučedol material we succeeded in proving also older statements by some authors about the fact that Vučedol apsidal houses belonged to the Kostolac culture, but without the pottery, this cannot be said about the Sarvaš.<sup>94</sup>

From the material we selected three characteristic shapes: the bowl, cup and glass. The portfolio of vessels in the Kostolac culture is very limited also at other finding sites. The partial reason lies in the fact that types have been simplified, which led to a decrease in the number of shapes, so that besides the shapes that we selected from our material also the type of a pot is present with a rounded or S-profiled body, often with handles at the belly or neck, that are named amphorae in the literature.<sup>95</sup>

### Bowls:

The majority of exemplars is represented by bowls, which confirms the fact that the fundamental distinction of the Kostolac culture is the bowl. Four basic models are represented:

1. Calotte-shaped bowls (cat. No. 29–37, fig. 24.1a-c)
2. Bowls with a rounded body (cat. No. 38, fig. 24.2a)
3. Bowls with an extended neck (cat. No. 39–42, fig. 24.3a-d)
4. S-profiled bowls (cat. No. 43, fig. 24.4a).

### Calotte shaped bowls

The lower section is completely rounded, so that is impossible to state where the base begins and where it ends. Some exemplars have a pronounced hollow at the base (*omphalos*). In the literature this bowl type is referred to as calotte-shaped.<sup>96</sup> They

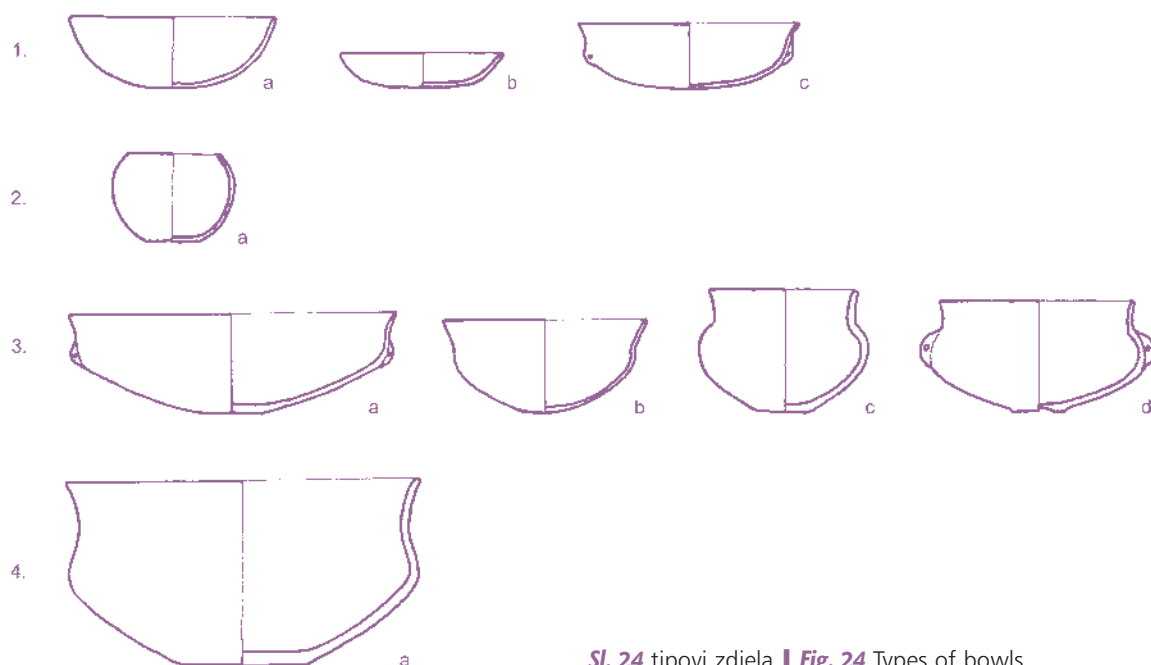

Sl. 24 tipovi zdjela | Fig. 24 Types of bowls

<sup>94</sup> Tasić 1979: 249; Nikolić 2000: 42–43; Balen 2002b: 44.

<sup>95</sup> Nikolić 2000: T. XXXIX:1–4.

<sup>96</sup> Tasić 1979: 254; Nikolić 2000: 49 (tip II), T.XXXIX:8; Petrović & Jovanović 2002: 228 (tipovi 5 i 6).

<sup>97</sup> Dimitrijević 1979: T. XXVII:3.

<sup>98</sup> Tom tipu posuda pripadaju i ulomci tijela, odnosno donjega dijela ili zaobljena dna koje ovdje nismo reproducirali, vidi Hoffiller 1938: T. 9:6–8,10; Balen 2002a: T. 4:5–6.



Sl. 25 zdjela, kat. br. 39 | Fig. 25 Bowl, cat. No. 39

- a. dublja zaobljena zdjela s ukrasom na sredini posude (kat. br. 30, 34, 35, sl. 24.1a).
- b. plitka posuda ravna ili izvijena ruba. Ukras izveden po sredini posude – s gornje strane je linija izvedena brazdastim urezivanjem, ispod koje je ukas najčešće izveden žigosanjem. Brazdasto urezana linija očituje se u profilu posude kao utor koji vizualno odvaja vrat od tijela zdjele, a često na unutarnjoj strani kao rebro (kat. br. 31–33, 36, 37, sl. 24.1b).
- c. zdjela izvijena ruba, s ušicama na sredini posude. Ukas zahvaća 2/3 posude (kat. br. 29, sl. 24.1c).

### Zdjele zaobljena tijela

Izdvojena je jedna varijanta tog tipa. Pod kat. br. 38 (sl. 24.2a) nalazi se jedan ulomak manje zaobljene zdjele uvučena ruba s ukrašenim gornjim dijelom. Taj tip nije toliko učestao na nalazištima, a sličnu zdjelu nalazimo u Ceriću<sup>99</sup> i u Kršincima.<sup>100</sup>

### Zdjele izvučena vrata

Obilježje tog tipa zdjela jest blago naglašena profilacija koja diferencira vrat posude. Nakon zaobljenih zdjela bez dna taj je tip dosta zastupljen na kostolačkim nalazištima.<sup>101</sup> Među građom iz Sarvaša koja se čuva u Arheološkome muzeju u Zagrebu izdvojene su njegove četiri varijante.

- a. zdjela konična vrata i ravna dna, s ušicama na ramenu. Ukas teče od ramena posude gotovo do dna (kat. br. 40, sl. 24.3a).
- b. dublja zdjela ravna dna, blago naglašena trbuha i konična vrata (kat. br. 42, sl. 24.3b).
- c. zdjela visoka cilindrična vrata, izvijena ruba i omphalos dna. Ukas na ramenu posude (kat. br. 39, sl. 24.3c, 25).
- d. zdjela cilindrična vrata, izvijena ruba i zaobljena trbuha (kat. br. 41, sl. 24.3d).

### Zdjela S-profilacije

Jedan ulomak zdjele (kat. br. 43, sl. 24.4a) možemo atribuirati tipu zdjela S-profilacije.

### Šalice:

Najprepoznatljiviji oblik posude koji se povezuje s kostolačkom kulturom svakako je šalica s trakastom ručkom koja nadvisuje rub. Među sarvaškim materijalom izdvojili smo jednu šalicu, nažalost bez sačuvane ručke (kat. br. 45).

Nalaz široke trakaste ručke (kat. br. 44) vjerojatno pripada tipu posude karakterističnom i izdvojenom među građom iz Gomolave. Riječ je o posudi duboka recijenta, izvučena vrata s visokom trakastom ručkom koja nadvisuje rub.<sup>102</sup>

### Čaše:

Tomu tipu pripisujemo jedan oblik konična tijela, blago izvijena ruba i ravna dna. Inače je to dosta čest tip posuda na nalazištu Vučedol,<sup>103</sup> a ima ga i na Gomolavi.<sup>104</sup>

represent the most typical vessel shape of the Kostolac culture, present almost at all Kostolac finding sites. Under the influence of the Kostolac culture it appears also in the earlier phase of the Vučedol culture.<sup>97</sup> Based on the analysed material, three varieties of the same type are singled out.<sup>98</sup>

- a. A deep rounded bowl with a decoration in the middle of the vessel (cat. No. 30, 34, 35, fig. 24.1a)
- b. A shallow vessel with a flat or everted rim. The decoration made in the middle of the vessel – at the upper section a line is made by grooved incision, below it the decoration is most often made by impressing. The line is impressed the vessel's profile that like a joint optically divides the neck from the vessel's body and is often placed on the inside like a rib (cat. No. 31-33, 36, 37, fig. 24.1b).
- c. A bowl with an everted rim and lugs in the middle of the vessel. The decoration encompasses 2/3 of the vessel (cat. No. 29, fig. 24.1c).

### Bowls with a rounded body

One variety of this type has been identified. Cat. No. 38 (fig. 24.2a) is a fragment of a gently rounded bowl with an indent rim and a decorated lower section. This variety is not very often found on these finding sites. A similar bowl is found in Cerić<sup>99</sup> and in Kršnici.<sup>100</sup>

### Bowls with an extended neck

The characteristic of this bowl type is a gently pronounced profilation that differentiates the neck of the vessel. After rounded bowls without a base, this type is very often present at the Kostolac finding sites.<sup>101</sup> Among the Sarvaš material stored in the Archaeological Museum in Zagreb four varieties are singled out.

- a. A bowl with a conical neck and a flat base, with lugs at the neck. The decoration stretches from the vessel's shoulder almost to the base (cat. No. 40, fig. 24.3a)
- b. A deeper bowl with a flat base and a gently pointed belly and a conical neck (cat. No. 42, fig. 24.3b)
- c. A bowl with a high cylindrical neck, everted rim and omphalos base. The decoration is placed at the vessel's neck (cat. No. 39, fig. 24.3c, 25)
- d. A bowl with a cylindrical neck, everted rim and rounded belly (cat. No. 41, fig. 24.3d).

### An S-profiled bowl

One fragment of a bowl (cat. No. 43, fig. 24.4a) can be attributed to the S-profiled bowls type.

### Cups:

The most typical shape that is immediately linked to the Kostolac culture is for sure the cup with a band-shaped handle that tops the rim. Among the Sarvaš material we singled out only one cup, unfortunately the handle has not been preserved (cat. No. 45). The find of the broad band-shaped handle (cat. No. 44) prob-

<sup>99</sup> Balen 2002a: T. 8:2.

<sup>100</sup> Marković 1994: T. 31:5.

<sup>101</sup> Petrović & Jovanović 2002: 228 (tip 1 i 2).

<sup>102</sup> Petrović & Jovanović 2002: 228 (šalica tip 1)

<sup>103</sup> Neobjavljena građa iz sustavnih istraživanja na položaju vinograd Streim.

<sup>104</sup> Petrović & Jovanović 2002: 105 (kat. br. 4)

Sve navedeno posuđe uglavnom je djelomično uglačane površine, što znači da su tragovi glačanja vidljivi na vanjskoj površini keramike kao tanke pruge. Keramika je dobre kvalitete, a najčešće je riječ o keramici normalne tvrdoće. Prevladavaju tamnosivi i tamnosmeđi tonovi, s presjekom također uglavnom tamnosivih ili tamnosmeđih tonova. Na nekim ulomcima boja vanjske stijenke varira od okerskih do smeđih tonova (mrljasto) što je vjerojatnije posljedica gorenja u požaru nego načina pečenja.

Materijal je klasično oblikovan, pa bi ga stoga trebalo pripisati klasičnoj fazi kulture. Najzastupljeniji su oblici, kao što smo već naveli, kalotasta zdjela bez izražena dna i zdjele izvučena vrata. Materijal karakterizira bogat dekorativni stil, upotpunjen bijelom inkrustacijom. Motivi su izvedeni brazdastim urezivanjem, urezivanjem, kraćim zarezivanjem, ubadanjem i žigosanjem, te su grupirani u horizontalne i vertikalne zone i polja. Žigosanje se obavljalo tupim alatima različita presjeka: najčešće ovalnog i kružnog.

## Vučedolska kultura

Eneolitička sekvenca na Sarvaša završava najpoznatijom kulturnom pojavom u nas. Vučedolska kultura nastala je u slavonsko-srijemskom prostoru potkraj eneolitika pod utjecajem drugoga vala migracije istočnostepskih naroda i kostolačke kulture. Visok standard ostvarivala je isprva gospodarstvom povezanim sa stočarstvom, a u kasnoj fazi rudarstvom i metalurgijom bakra, oslonjenom na nove revolucionarne tehnološke procese – serijsko lijevanje u dvodijelnim kalupima. Potreba za bakrom rezultirala je ekspanzijom vučedolske kulture iz matične Slavonije u širok prostor središnje i jugoistočne Europe.

Vučedolska populacija naselila se na ovom istaknutom povoljnom položaju, državši tako pod kontrolom široku, gospodarski bogatu regiju. Naseljavanje tela značilo je zauzimanje važna strateškoga i komunikacijskoga punkta.<sup>105</sup>

Po Schmidtu vučedolski stratuum nalazi se od 2,00 do 3,00 m relativne dubine (sloj IV). Također navodi dva građevinska horizonta, objekte i grobove.<sup>106</sup>

Dimitrijević dijeli Schmidtov sloj IV na dva: mlađi od 2,00 do 2,60 m, i stariji od 2,60 do 3,20 m.<sup>107</sup>

Zaštitnim iskopavanjima 1985. i 1986. otkriven je također bogat vučedolski sloj. J. Šimić spominje da je otkriven jedan stambeni objekt s mjestimice sačuvanim podom, bez nalaza. Keramika u sloju je gruba, a prevladavaju veći i manji lonci ukrašeni otiscima prsta s ručkom.<sup>108</sup>

Većina keramičkoga materijala koja se čuva u Arheološkom muzeju u Zagrebu pripada vučedolskoj kulturi. Dominira keramika tamnosivih i tamnosmeđih tonova, vrlo dobre fakture, rađena od dobro pročišćene gline bez primjesa pijeska. Velika je zastupljenost posuda fine fakture, odnosno zaglađene površine. Među građom izvojeno je nekoliko osnovnih tipova posuđa: lonci, zdjele, vrčevi, šalice, posude na nozi, te neki posebni oblici, nestandardna keramička produkcija, u koje smo

ably belongs to the vessel type typical and singled out among the material from Gomolava. It is a vessel with a deep container, an extended neck with a high band-shaped handle that tops the rim.<sup>102</sup>

### Glasses

To this type we attribute one shape with a conical body, a gently everted rim and a flat base. It is a vessel type very often found at Vučedol<sup>103</sup> and is also present in Gomolava.<sup>104</sup>

All the ware has mainly a partly polished surface, which means that traces of polishing are visible on the outside surface of the pottery like tiny stripes. The pottery is of good quality and mostly it is of normal consistency. Dark grey and dark brown colours prevail, with a break that is also mainly dark grey and dark brown. On some of the fragments the outside wall colour varies from ochre to brown shades (spotty) which is probably the consequence of burning in a fire than based on the baking procedure.

The material is classically shaped, and should therefore be attributed to the classical phase of the culture. The mostly represented shapes are, as we have already stated, calotte-shaped bowls without a pronounced base and bowls with an elongated neck. The material is characterized by a richly decorated style, filled in with white encrustation. The motifs are made by grooved incision, incision, short notching, stabbing and impressing and are grouped in horizontal and vertical zones and fields. The impressing was carried out with obtuse tools of different sections, mainly oval and circular.

## The Vučedol culture

The Eneolithic sequence at the Sarvaš site ends with the best known culture on our territories. The Vučedol culture originated in the area of Slavonia and Srijem at the end of the Eneolithic period under the influence of the second migration wave of eastern-steppe peoples and the Kostolac culture. The high standard was reached in the first phase by the rural economy linked to cattle-breeding and in a later phase to mining and copper metallurgy that was supported by the new revolutionary technological processes – the series casting in bipartite moulds. The need for copper resulted from the expansion of the Vučedol culture from the original location in Slavonia towards the broad space of central and south-east Europe.

The Vučedol population inhabited this most favourable position, controlling thereby a broad and economically rich region. Inhabiting tells meant positioning oneself on an important strategic and communication point.<sup>105</sup>

According to Schmidt, the Vučedol stratum is placed from 2,00 to 3,00 m of relative depth (layer IV). He also mentions two building horizons, objects and graves.<sup>106</sup>

Dimitrijević divides Schmidt's layer IV into two: a younger one from 2,00 to 2,60 m and an older one from 2,60 to 3,20 m.<sup>107</sup>

During the preservation excavations in 1985 and 1986 a rich Vučedol layer was also revealed. J. Šimić mentions that a living

<sup>105</sup> Durman 1995.

<sup>106</sup> Schmidt 1945: 129, 145–146.

<sup>107</sup> Dimitrijević 1968: 27.

<sup>108</sup> Šimić 1986a: 24.

Sl. 26 lonac, kat. br. 64 | Fig. 26 Pot, cat. No. 64





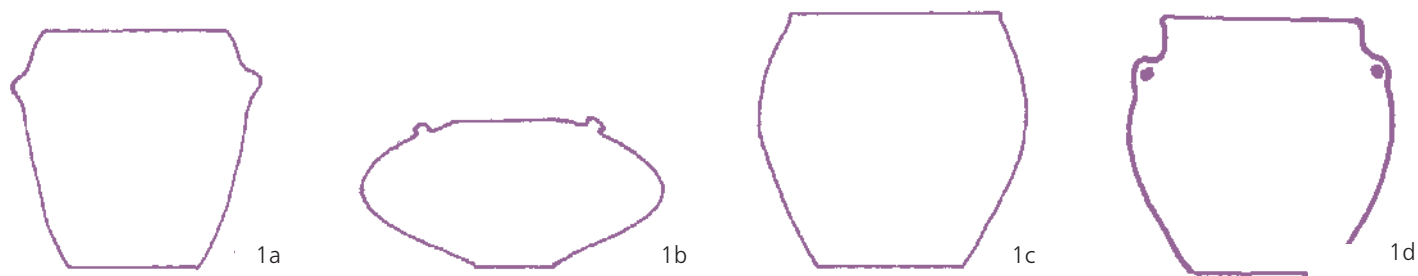

Sl. 27 tipovi lonaca | Fig. 27 Types of pots

ubrojili četvrtaste, zidne i trodijelne posude, zatim kultne predmete, plastiku te kalupe za lijevanje bakrenih predmeta.<sup>109</sup>

### Lonci:

Od lonaca smo uspjeli izdvojiti dva tipa:

1. lonci zaobljena tijela pojavljuju se u nekoliko varijanti:
  - a. zaobljena tijela i ravna ruba (kat. br. 47–49, sl. 27.1a)
  - b. zaobljena tijela i uvučena ruba, jako naglašena trbuha (kat. br. 50–56, sl. 27.1b)<sup>110</sup>
  - c. zaobljena tijela i blago izvijena ruba (kat. br. 57–65, sl. 27.1c)

2. lonci S-profilirana tijela (kat. br. 66–82, sl. 27.2a)  
Lonci dolaze u dvije kategorije: keramika je zaglađena, tankih stijenki i bez primjesa, tzv. fine fature te ona od slabo pročišćene gline, debljih stijenki, tzv. grube fature. Među materijalom nema velikog posuđa za zalihe (tzv. pitosi) već samo standardno posuđe za svakodnevnu kućnu upotrebu. Ukrašavanje posuda grube fature uglavnom je u obliku plastičnih traka s otiscima vrhova prstiju ili nokta (kat. br. 58, 60), obično postavljenim u dva reda, jedan uz rub posude, a drugi na prijelazu vrata u tijelo posude (kat. br. 69, 70). Umjesto plastične trake zastupljeno je i obično urezivanje nokata ili otisaka prstiju, najčešće pod samim rubom (kat. br. 57, 59, 63). Vratna zona često je kod takvoga tipa posuđa zaglađena, dok je donji dio hrapav, odnosno prevučen tankim namazom gline (barbotinom) ili je pokriven gustim snopovima urezanih linija (kat. br. 71–74, 77, 79–80). Kao funkcionalno-dekorativni element na loncima dosta često susrećemo tunelaste ušice (kat. br. 74, 78, 79), ručnice (kat. br. 75) ili plastične bradavičaste aplikacije (kat. br. 73), ili kombinaciju dvaju ili triju elemenata (kat. br. 76, 80).

Lonci fine fature ukrašeni su rovašenjeim i brazdastim urezivanjem, ispunjenim bijelom inkrustacijom. Kod lonaca S-profilacije ukras je postavljen po istom principu kao i kod istog tipa posuđa grube fature: ispod ruba je ukras u vidu urezane linije, zatim je vrat posude neukrašen, te od ramena posude teče ukras. Ukras je izveden u arhitektonskom stilu, motivi su složeni u zone, odnosno frizove i metope (kat. br. 64–65, 81, sl. 26). Lonci bez vrata, zaobljena tijela i uvučena ruba, ukrašeni su u gornjem segmentu ili na najširem dijelu, tj. na truhu posude. Često imaju i čepastu aplikaciju za prihvat uz rub (kat. br. 50, 54).

place was revealed with a partly preserved floor and no finds. The pottery in that layer is coarse, larger and smaller pots prevail decorated with fingerprints with a handle.<sup>108</sup>

The majority of the ceramic material stored in the Archaeological Museum in Zagreb belongs to the Vučedol culture. The pottery of dark grey and dark brown dominates, very well fabricated, made of well polished clay with no sand impurities. Vessels of fine manufacture, i.e. polished surface are dominant.

Among the material few basic ware types have been singled out: pots, bowls, jars, cups, vessels on a foot, some special shapes, non-standard pottery production to which square, wall-hung and tripartite vessels belong, cult items, models and moulds for casting copper items.<sup>109</sup>

### Pots:

Three pot types could be singled out:

1. Pots with a rounded body are present in few varieties:
  - a. a rounded body and a flat rim (cat. No. 47–49, fig. 27.1a)
  - b. a rounded body and an indented rim, with a very pronounced belly (cat. No. 50–56, fig. 27.1b)<sup>110</sup>
  - c. a rounded body and a gently everted rim (cat. No. 57–65, fig. 27.1c)
2. S-profiles pots (cat. No. 66–82, fig. 27.2a)

Pots come in two categories: the pottery is mostly polished, with narrow walls and with no impurities of a so called fine manufacture and those of a poorly purified clay with thicker walls of the so called coarse manufacture. Among the material there is no large ware for stocks (so called »pithoi«) but merely the standard ware for every-day household use. The decoration of coarsely manufactured ware consists mainly of relief applied bands with imprints of finger tips or nails (cat. No. 58, 60) usually divided in two rows, one at the vessel's rim, the other at the section between the neck and the vessel's body (cat. No. 69, 70). Instead of the relief applied band also the simple incision of nails or fingerprints is present, most often below the very rim (cat. No. 57, 59, 63). The neck area in such ware type is usually mostly polished, whereas the lower section is rugged, i.e. covered with a light layer of clay (barbotine) or thick bundles of incised lines (cat. No. 57, 59, 63). As a functional and decorative element very often we encounter tunnel-shaped lugs (cat. No. 74, 78, 79), small

<sup>109</sup> Iz Muzeja Slavonije u Osijeku objavljeno je nekoliko predmeta, uglavnom posuda vučedolske kulture sa Schmidtovih iskopavanja, vidi: J. Šimić 1995: kat. br. 3.3–3.7, 3.10–3.16, 4.13, 6.4; ista 1997: kat. br. 23–26.

<sup>110</sup> U literaturi ovaj tip često ima naziv piriformna posuda ili kruškolika vaza, vidi: Dimitrijević 1956: 18. Za neke od analogija vidi: Orion 2000: kat. br. 5,6,27



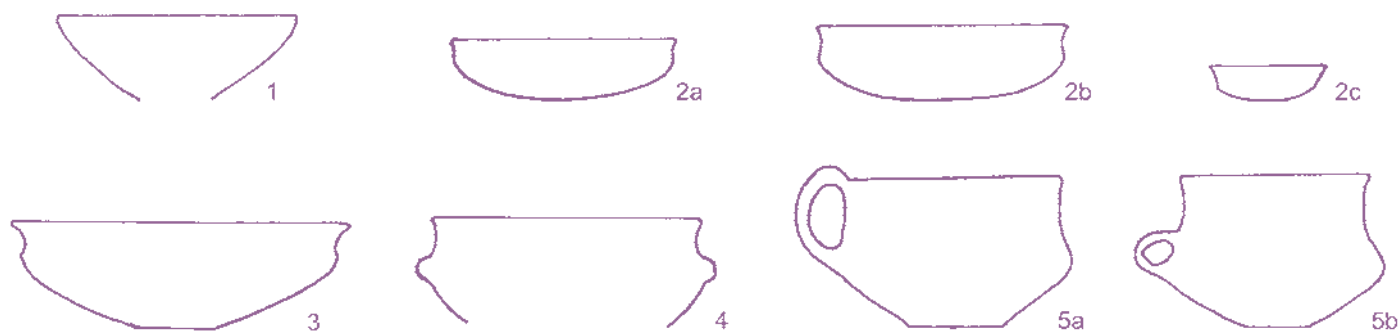

Sl. 29 tipovi zdjela | Fig. 29 Types of bowls

### Zdjele:

Izdvojili smo nekoliko tipova zdjela:

1. zdjele zaobljena tijela (kat. br 83–89)
2. kalotaste zdjele (kat. br. 90–100, 113–116)
3. zdjele izvučena vrata (kat. br. 101–109)
4. S-profilirane zdjele (kat. br. 110–112)
5. bikonične zdjele ili terine (kat. br. 117–151)
6. konične zdjele (kat. br. 179–181)

### Zdjele zaobljena tijela

Tip zaobljenih dubokih zdjela sa zadebljanim rubom (sl. 29.1) ima glatku, mat površinu uglavnom tamnih tonova. Takve posude nisu ukrašene, osim možda njihova ruba, i to otiskom prsta ili nokta ili urezivanjem (kat. br. 88).

### Kalotaste zdjele

To je tip plitkih zdjela sa zaobljenim ili omphalos dnom (kat. br. 93, 96, 99) najčešće uglačane površine, također tamnih tonova. Na materijalu iz Sarvaša možemo izdvojiti tri varijante toga tipa:

- a. plitka zdjela sa zaobljenim dnom, blago izvijena vrata (kat. br. 90–94, 113, 114, sl. 28, 29.2a)  
Te su zdjele bogato ukrašene – vratni je segment neukrašen (osim ispod samoga ruba urezanom linijom), dok je donji konus posve ukrašen. Ukrašen je izveden tako da je podijeljen u četiri polja (kat. br. 90, 91, 93, 94). Prisutan je i drugi tip ukrašavanja – u obliku trake na najširem dijelu, odnosno ramenu posude (kat. br. 92).
- b. plitka zdjela sa zaobljenim dnom, naglašena, bikonična ramena i izvijena ruba (kat. br. 95–99, 115, 116, sl. 29.2b)  
Te zdjele češće imaju ukras na sredini, odnosno na ramenu posude, u uskoj traci, ali je na nekim primjercima ukrašen donji segment ili dno zdjele (kat. br. 115, 116).
- c. konična plitka zdjela s omphalos dnom (kat. br. 100, sl. 29.2c).<sup>111</sup>

### Zdjele izvučena vrata

To je dublja zdjela, naglašena, blago bikonična ramena, izvijena, kratka vrata i ravna dna (kat. br. 101–109, sl. 29.3). Ukrašen je najčešće postavljen na prijelomu u uskoj traci, ali čest je i ukras na vratnom segmentu pojedinačnih motiva rombova (kat. br. 107, 109) ili okomitih linija (kat. br. 101).

### Zdjele S-profilacije

Izdvojeno je nekoliko posuda toga tipa (sl. 29.4). Ukrašen je vratni segment zdjela.

handles (cat. No. 75) or relief applied nipple-shaped forms (cat. No. 73) or a combination of two or three elements (cat. No. 76, 80).

Pots of fine manufacture are decorated by notching and grooved incision, filled with white encrustation. The decoration on S-profiled pots is placed in line with the same principle as on the same ware type of coarse manufacture: below the rim there is a decoration in the form of an incised line, the neck is not decorated and from the vessel's shoulder onwards the decoration continues. The decoration is made in an architectural style, motifs are grouped in zones i.e. in mouldings and metopes (cat. No. 64–65, 81, fig. 26). Pots with no neck, and a rounded body and indent rim, decorated on the upper section or at the broadest section, i.e. at the vessel's belly. They often present a stopper-like application for handling along the rim (cat. No. 50, 54).

### Bowls:

Few bowl types have been singled out :

1. bowls with a rounded body (cat. No 83–89)
2. calotte-shaped bowls (cat. No. 90–100, 113–116)
3. bowls with an extended neck (cat. No. 101–109)
4. S-profiled bowls (cat. No. 110–112)
5. biconical bowls or terrines (cat. No. 117–151)
6. conical bowls (cat. No. 179–181)

### Bowls with a rounded body

The type of deep, rounded bowls with a thickening rim (fig. 29.1) has a matte surface, and is mainly of dark colours. Such vessels are not decorated, except for maybe the rim that is decorated with fingerprints, nails or by incision (cat. No. 88).

### Calotte-shaped bowls

This is the type of shallow bowls with a rounded or an omphalos base (cat. No. 93, 96, 99) most often of a polished surface, also of dark colours. On the Sarvaš material three varieties of the same type can be distinguished:

- a. shallow bowl with a rounded base, a gently everted rim (cat. No. 90–94, 113, 114, fig. 28, 29.2a)  
These bowls are richly decorated – the neck section is not decorated (except for the incised line below the rim), whereas the lower cone is completely covered with decorations. The decoration is divided into four fields (cat. No. 90, 91, 93, 94). Also another decoration style is present – in the shape of a band at the broadest section – the vessel's shoulder (cat. No. 92, fig. 29.2b).

<sup>111</sup> Gotovo identična posudica potječe iz Vučedola, vidi: Orion 2000: kat. br. 11.



Sl. 30 zdjela, kat. br. 94 | Fig. 30 Bowl, cat. No. 94



Sl. 31 terina, kat. br. 120 | Fig. 31 Terrine, cat. No. 120

### Bikonične zdjele – terine

Iako se u literaturi često navode kao zaseban tip unutar vučedolske keramografije, terine su zapravo poseban tip zdjela čiji se bikonični prijelom nalazi točno na polovici posude (kat. br. 117–151). Upravo su zbog svoje učestalosti, a zasigurno pripadaju najtipičnijoj vrsti posuda vučedolske kulture, izdvojene u zaseban tip. Vrat je uvučen, konkavan, a rub izvišen. Imaju ili tunelastu ručku na bikonitetu (kat. br. 117–119, sl. 29.5b) ili trakastu ručku koja spaja rub i trbuh posude (kat. br. 120–121 sl. 29.5a, 31). Ručke su u pravilu ukrašene (kat. br. 122–139), kao i bikonični prijelom terine. Ukras je izveden kao traka na ramenu (kat. br. 117) ili je ukrašen vrat posude (kat. br. 120–121). Također je čest ukras s motivom sunca na bikoničnom prijelomu (kat. br. 140–141, 143–148). Puno rjeđe ukrašen je i donji, konveksni dio terine (kat. br. 118).<sup>112</sup>

### Konične zdjele

Taj tip zdjela u pravilu nije ukrašen, osim plastičnim aplikacijama koje su služile za prihvat (kat. br. 179).

### Šalice:

Izdvojena su tri tipa šalice (kat. br. 152–157):

1. plitka šalice zaobljena tijela, izvučena ruba i zaobljena dna (kat. br. 156 sl. 32.1)



Sl. 32 tipovi šalice | Fig. 32 Types of cups

- b. A shallow bowl with a rounded base, pronounced, biconical shoulders and an everted rim (cat. No. 95–99, 115, 116)

Such bowls more frequently present a decoration in the middle, respectively at the vessel's shoulder in the form of a narrow band. On some artefacts however, the lower segment or the bowl's base is decorated (cat. No. 115, 116).

- c. A conical, shallow bowl with an omphalos base (cat. No. 100, fig. 29.2c).<sup>111</sup>

### Bowls with an extended neck

It is a deeper bowl, with pronounced and gently biconical shoulders, an everted and short neck and a flat base (cat. No. 101-109, fig. 29.3). The decoration is most often placed at the break in the form of a narrow band, but also the decoration at the neck section is often with single rhombus motifs (cat. No. 107, 109) or vertical lines (cat. No. 101).

### S-profiled bowls

Few vessels of that type have been singled out (fig. 29.4). The neck section of the bowls is decorated.

### Biconical bowls – terrines

Although in the literature they are often mentioned as a separate type within the Vučedol pottery, terrines are actually a separate type of bowls whose biconical break is placed exactly at half of the

<sup>112</sup> Šimić 1997: 18, kat. br. 3.12 (manja terina s ukrašenim donjim dijelom iz fundusa Muzeja Slavonije u Osijeku)

2. bikonična šalica izvučena ruba i ravna dna (kat. br. 152–155 sl. 32.2).
3. zaobljena šalica prstenasta dna (kat. br. 157, sl. 32.3).<sup>113</sup>

#### Vrčevi:

Vrčevi su relativno rijedak oblik za vučedolsku kulturu. Javljaju se u B-2 stupnju vučedolske kulture, a masovnije su tek u brončano doba, kod nosioca vinkovačke kulture. Među nalazima koji se čuvaju u AMZ-u izdvojen je samo tip vrča S-profilirana tijela (kat. br. 158–159).

#### Amfore:

Za vučedolsku kulturu karakterističan je tip posude cilindrična vrata, u literaturi nazivan amfora. Zastupljena su dva tipa: s visokim ili kratkim cilindričnim vratom te s bikoničnim (kat. br. 160–161, sl. 33). ili zaobljenim tijelom (kat. br. 162).<sup>114</sup>

#### Posude na nozi:

Uz bikonične zdjele ili terine, vučedolsku kulturu obilježavaju i različiti oblici posuda na nozi. Među građom izdvojili smo nekoliko tipova:

1. posude na četiri noge (kat. br. 164–167)  
Među obrađenim predmetima izdvojene su dvije varijante toga tipa:<sup>115</sup>

vessel (cat. No. 117–151). Due to their prevalence – they belong indeed to the most typical vessel type of the Vučedol culture, they are singled out as a separate type. The neck is indent, dispersive and the rim is everted. They either have a tunnel-shaped handle at the biconical section (cat. No. 117, 119, fig. 29.5b) or a band-shaped handle that connects the rim to the vessel's belly (cat. No. 120–121, fig. 29.5a, 31). As a rule handles are decorated (cat. No. 122–139) like the biconical break of the terrine. The decoration is in the shape of a band made at the shoulder (cat. No. 117) or the vessel's neck is decorated (cat. No. 120–121). Also very frequent is the decoration in the shape of the Sun at the biconical break (cat. No. 140–141, 143–148). Rarely also the lower section, the dispersive part of the terrine is decorated (cat. No. 118)<sup>112</sup>.

#### Conical bowls

This bowl type is as a rule not decorated, except for the relief applied applications that serve for holding (cat. No. 179).

#### Cups:

Three cup types have been singled out (cat. No. 152–157):

1. A shallow cup with a rounded body, an extended rim and a rounded base (cat. No. 156, fig. 32.1)
2. A biconical cup with an extended rim and a flat base (cat. No. 152–155, fig. 32.2).



Sl. 33 amfora, kat. br. 160 | Fig. 33 Amphora, cat. No. 160

<sup>113</sup> isti tip postoji i na Vučedolu, vidi Schmidt 1945: T. 33:6, T. 34:1.

<sup>114</sup> Među ovdje obrađivanim materijalom zastupljen je samo tip kratka vrata, analogije vidi u: Orion 2000: kat. br. 7, 57. Za primjerke posuda s visokim cilindričnim vratom vidi: Dimitrijević 1979c: T. XXVIII:6, T.XXX:1,3,8.

<sup>115</sup> Na nalazištima vučedolske kulture ustanovljene su još dvije varijante toga tipa, zdjela S-profilirana tijela i plitka četvrtasta zdjela, vidi: Orion 2000: kat. br. 23, kat. br. 24. Za plitku četvrtastu zdjelu smatra se da je bila korištena u kultne svrhe, vidi: Težak 1975: 10–11.

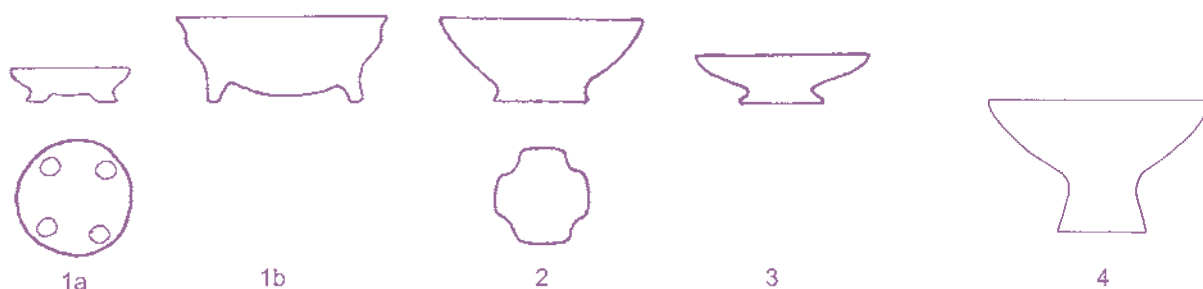

Sl. 34 tipovi posuda na nozi | Fig. 34 Types of vessels on foot

- a. zaobljena zdjelica (kat. br. 164, sl. 34.1a)
- b. bikonična zdjela (kat. br. 165–167, sl. 34.1b)
2. posude na prstenastoj križnoj nozi (kat. br. 168, 173–175, sl. 34.2)  
Najčešći je oblik zaobljena zdjela (kat. br. 168).<sup>116</sup> Ulomci pod kat. br. 170 i 171 najvjerojatnije pripadaju tom tipu posuda.
3. posude na prstenastoj punoj nozi (kat. br. 169, 172, sl. 34.3)  
Konična kupa najčešći je oblik postavljen na uskoj prstenastoj nozi.
4. posude na višoj cilindričnoj nozi (kat. br. 163, sl. 34.4)

#### Ostali keramički oblici

Navedenim standardnim oblicima, među materijalom iz Sarvaša, pridružuje se i niz specifičnih oblika, karakterističnih upravo za keramografiju vučedolske kulture. Među njih ubrajamo višedijelne boce (kat. br. 201–203, sl. 35),<sup>117</sup> viseće zidne posude u obliku modela krušne peći (kat. br. 183–186, sl. 36),<sup>118</sup> četvrtaste posude (kat. br. 177, 178)<sup>119</sup> i ovalne posude s pregradom, tzv. soljenke (kat. br. 182).<sup>120</sup>

Među građom iz Sarvaša ustanovljena su četiri oblika, koja zbog svojih dimenzija možemo klasificirati kao dječje igračke. Jedan je imitacija žrtvenoga stolića (kat. br. 195), jedan plitke konične zdjelice (kat. br. 181), a ostala dva kupa na više nogu (kat. br. 164, 194, 196).

Iz materijala je izdvojena i posuda konična oblika (kat. br. 176), ali bez sačuvana ruba, tako da točnu tipološku pripadnost nismo u mogućnosti odrediti. Uglačane je površine, tamne boje, karakteristične eneolitičke fature, s ukrašenim izvedenim urezivanjem s unutrašnje strane i na dnu.

Izdvojeno je također sedam čitavih ili fragmentiranih predmeta – uskih šupljih grla koja se na jednom kraju konično proširuju (kat. br. 187–193), a često se u literaturi navode kao grla za kožne mjevove.<sup>121</sup> Osim u Sarvašu, dosta ih je nađeno i na Vučedolu. Moramo spomenuti da su možda korišteni i kao lijevci;<sup>122</sup> naime slični, ali ukrašeni primjerci iz kneževskih grobova u Crnoj Gori upravo se atribuiraju kao lijevci.<sup>123</sup>

3. A rounded cup with a ring-shaped base (cat. No. 157, fig. 32.3)<sup>113</sup>

#### Jars:

Jars are a relatively rare shape for the Vučedol culture. They are present in the phase B-2 of the Vučedol culture and are much more frequent as late as during the Bronze Age among the bearers of the Vinkovci culture. Among our material only the jar type with an S-profiled body has been singled out (cat. No. 158–159).

#### Amphorae:

Typical for the Vučedol culture is the type of vessels with a cylindrical neck, in the literature referred to as »amphorae«. Amphorae are represented in two types: with a long or a short cylindrical neck, a biconical (cat. No. 160–161, fig. 33) or a rounded body (cat. No. 162).<sup>114</sup>

#### Vessels on a foot:

Along with biconical vessels or terrines, the Vučedol culture is characterized by different shapes of vessels on a foot. Among the material few types have been singled out:

1. vessels on four feet (cat. No. 164–167)  
Among the analysed material two varieties of that type have been selected<sup>115</sup>
  - a. a small, rounded bowl (cat. No. 164, fig. 34.1a)
  - b. a biconical bowl (cat. No. 165–167, fig. 34.1b)
2. vessels on a ring-shaped cross foot (cat. No. 168, 173–175, fig. 34.2)  
The most frequent shape is the rounded bowl (cat. No. 168).<sup>116</sup> The fragment under cat. No. 170 and 171 most likely belong to this type of vessel.
3. vessels on a ring-shaped full foot (cat. No. 169, 172, fig. 34.3)  
The conical chalice is the most frequent shape placed on the narrow, ring-shaped foot.
4. vessels on a higher cylindrical foot (cat. No. 163, fig. 34.4)

<sup>116</sup> Orion 2000: kat. br. 22, 35, 36, 40.

<sup>117</sup> Dvodijelna boca potječe iz Starih Mikanovaca, vidi: Vučedol 1988: kat. br. 47.

<sup>118</sup> Pronađene su na Vučedolu, položaj Gradac: Schmidt 1945: T.42:1; Dimitrijević 1979c: T. XXIX: 6; položaj Vinograd Streim: Vučedol 1988: kat. br. 11–13; u Vinkovcima: Vučedol 1988: kat. br. 14.

<sup>119</sup> Isti oblik poznat je i s Vučedola, vidi: Schmidt 1945: T. 42:5–7.

<sup>120</sup> Za Vučedol vidi: Schmidt 1945: T. 42:9; za Vinkovce: Vučedol 1988: kat. br. 190.

<sup>121</sup> Schmidt 1945: T. 43:2–3; Dimitrijević 1956: 20.

<sup>122</sup> U sarvaškoj kartoteci kao i u inventarnim muzejskim knjigama ti nalazi zavedeni su kao lijevci.

<sup>123</sup> Saveljić Bulatović & Lutovac 2003: 31, kat. br. 6.4.

<sup>124</sup> Vučedol 1988: kat. br. 187–189 (nalazišta Vinkovci, Stari Mikanovci, Vučedol).



Sl. 35 trodijelna posuda, kat. br. 201 | Fig. 35 Threepartite vessel, cat. No. 201





Poklopac u vučedolskoj kulturi (kat. br. 225) nije toliko učestao oblik, iako ga sporadično nalazimo i na drugim nalazištima vučedolske kulture.<sup>124</sup> Možda razlog malom broju poklopaca možemo tražiti i u Dimitrijevićevoj postavci po kojoj su funkciju poklopca imale male kalotaste zdjelice bez izražena dna.<sup>125</sup>

### Kulturni predmeti

U vučedolskoj kulturi postoje i neki tipovi predmeta za koje se nedvojbeno smatra da su imali kulturno značenje. Najvažniji su žrvenici sedlasta ili rogolika tipa.<sup>126</sup> Uglavnom su neukrašeni, a upravo se po bogatom ukrasu ističe jedan primjerak iz Sarvaša (sl. 37).<sup>127</sup>

Drugi tip kulturnih predmeta su žrtveni stolići.<sup>128</sup> Primjerke iz Sarvaša spominje već Bosendorfer, navodeći da je upravo za Sarvaš karakterističan tip predmeta stolić ili menza s ukrašenim širokim rubom koji se proširuje te prelazi u cilindrične noge.<sup>129</sup>

Među građom koja se čuva u Arheološkom muzeju u Zagrebu samo smo jedan ulomak (kat. br. 207) mogli pripisati tipu sedlastoga žrtvenika, a za mali okrugli stolić (kat. br. 195) smatramo da je ipak bio dječja igračka.

U kultne predmete ubrajamo i kadionice, odnosno bikonične posude iz dva dijela s nizom rupica (kat. br. 197–200, sl. 38).<sup>130</sup>

### Plastika

Iz Sarvaša potječu i tri keramička modela nogu, koja nam vjerno pokazuju dva tipa obuće korištene u kasnom eneolitu, odnosno u vučedolskoj kulturi.



Sl. 37 žrtvenik (predmet se čuva u MSO, foto: predmetna kartica, arhiv AMZ) | Fig. 37 Altar (the item is stored in MSO, photograph: Cart of items, holdings AMZ)

### Remaining ceramic shapes

Among the Sarvaš material a series of specific shapes, typical of the Vučedol pottery, is joined to the already listed standard shapes. Herein we include multi-part bottles (cat. No. 201–203, fig. 35),<sup>117</sup> wall-hung vessels in the shape of bread oven (cat. No. 183–186, fig. 36),<sup>118</sup> square vessels (cat. No. 177, 178)<sup>119</sup> and oval vessel with a barrier, so called salt-cellars (cat. No. 182)<sup>120</sup>

In the Sarvaš material four shapes have been identified that due to their dimensions can be classified as children's toys. One of them is the imitation of a sacrificial table (cat. No. 195), the second of a shallow, conical bowl (cat. No. 181) and the remaining is a chalice on more feet (cat. No. 164, 194, 196).

From the material also a vessel of a conical shape (cat. No. 176) has been singled out but the rim has not been preserved. Therefore, we are unable to define where it belongs to in terms of typology. It has a polished surface, dark colour, typical Eneolithic manufacture with a decoration made by incision on the inside part and at the base.

In the Sarvaš material seven whole or fragment items have been singled out – narrow, hollow necks that widen conically at one end (cat. No. 187–193) that are frequently interpreted in the literature as throats for leather bellows.<sup>121</sup> Except for Sarvaš, many of them are found also at Vučedol. It must be mentioned that they might have been used also as funnels<sup>122</sup> In fact, the exemplars from counts' graves in Montenegro are considered funnels.<sup>123</sup>

The lid (cat. No. 225) is not a frequent shape in the Vučedol culture, although it is sporadically found at other finding sites of the Vučedol culture.<sup>124</sup> The reason for the low number of lids can be seen also in Dimitrijević's thesis according to which the function of lids was performed by small calotte-shaped bowls without a pronounced base.<sup>125</sup>

### Cult objects

In the Vučedol culture there are certain types of items that are undoubtedly considered to have had a cult meaning. The most important are saddle or horn-shaped<sup>126</sup> altars. They are mainly not decorated, although an exemplar from Sarvaš stands out exactly due to its rich decoration (fig. 37).<sup>127</sup>

The second type of cult objects are small sacrifice tables<sup>128</sup>. The Sarvaš exemplars are already mentioned by Bosendorfer who mentioned that exactly of the Sarvaš the characteristic kind of item is the small table with a decorated, broad edge that widens and proceeds into the cylindrical feet.<sup>128</sup>

Among the material stored at the Archaeological Museum in Zagreb only one fragment (cat. No. 207) can be attributed to the type of the saddle-shaped altar. As regards the small round table (cat. No. 195), we believe it still was a children's toy.

<sup>125</sup> Dimitrijević 1956: 17.

<sup>126</sup> Dimitrijević 1979c: 294; Milićević 1988: 30; Hoti 1990.

<sup>127</sup> nalazi se u Muzeju Slavonije u Osijeku, vidi: Dimitrijević 1979c: T. XXXIV:1.

<sup>128</sup> Schmidt 1945: T. 51:2; Dimitrijević 1979c: T. XXXIV:2; Težak 1975: sl. 6–13, 19–20.

<sup>129</sup> Bosendorfer 1942: 20.

<sup>130</sup> Težak 1975: 12.

ut una tri  
braka in kasto  
i nite boje i divlj  
mole njehe  
su porec po mede  
sui moti vone v  
mnoti vone v  
mnoti vone v  
mnoti vone v



Materijal:   
 vrsta:   
 težina: 14,8 cm, 6,5 cm  
 površina: 14,8 cm, 6,5 cm  
 površina: 14,8 cm, 6,5 cm

Gornji dio jance  
 kadionice tauru  
 i nite boje i divlj  
 v po cijeloj  
 površini  
 s. m. crtama  
 s. m. crtama  
 površina: 14,8 cm, 6,5 cm  
 površina: 14,8 cm, 6,5 cm



7864

Sl. 38 Gornji dio kadionice, kat. br. 200 |  
 Fig. 38 The upper section of a censer, cat. No. 200

Primjerak pod kat. br. 204 vjerna je reprodukcija čizme od tvrde kože, možda svinjske, dok modeli pod kat. br. 205–206 prikazuju drugi tip čizme ili visoke cipele od meke kože koje su se vezale iznad gležnja.<sup>131</sup>

### Metalurški proizvodi

Kalupe za lijevanje listolikih bodeža (sl. 39) i dlijeta (sl. 40) Schmidt isprva pripisuje badenskoj kulturi.<sup>132</sup> Njihovu kronološku važnost prvi je naveo Miložić, usporedivši ih s primjercima iz ostave Poliokhni.<sup>133</sup> Dimitrijević je na temelju sačuvane dokumentacije utvrdio da su kalupi bili inventar vučedolske jame ukopane u badenski kulturni sloj. Tu »ljevačku jamu« datirao je u B1 stupanj.<sup>134</sup>

Iako vučedolska kultura poznaje dva tipa bodeža s trnom na koji se nasađivala drška: sa ili bez središnjeg pojačanoga rebra,<sup>135</sup> naši primjerci djeluju dosta nefunkcionalno te je u literaturi već razmatrano pitanje njihove drugačije funkcije: kao britva ili nož.<sup>136</sup>

\* \* \*

Oblici koji se pojavljuju u Sarvašu karakteristični su za B1 i B2 stupanj vučedolske kulture. Za B1 stupanj Dimitrijević navodi karakteristične oblike trodijelne flaše, zidne posude, kadionice, zdjele na čepastim nogama.<sup>137</sup> Za B2 stupanj

Censers – i.e. biconical vessels of two parts with rows of holes – are also considered cult objects (cat. No. 197–200, fig. 38).<sup>129</sup>

### Models

From the Sarvaš originate also three feet models, that faithfully show two kinds of footwear used in the late Eneolithic, respectively in the Vučedol culture.

The exemplar cat. No.24 is a faithful reproduction of a boot of hard leather, maybe swine, whereas the models cat. No. 205–206 show a different type of boot or high shoe of smooth leather lashed below the ankle.<sup>130</sup>

### Metallurgic products

Schmidt attributed the moulds for casting leaf-like daggers (fig. 39) and chisels (fig. 40) to the Baden culture.<sup>131</sup> Their chronological importance was firstly mentioned by Miložić who compared them to the exemplars from the Poliokhni hoard.<sup>132</sup>

Based on the preserved documentation Dimitrijević found out that the moulds were the inventory from the Vučedol pit embedded into the Baden cultural layer. He dated this »casting pit« to the phase B1.<sup>134</sup>

Although the Vučedol culture knew of two types of daggers – with a spine on which the handle was placed with or without the central, reinforced rib<sup>135</sup> – our exemplars seem pretty non-



Sl. 39 dvodijelni kalup za lijevanje bodeža, kat. br. 226 | Fig. 39 Bipartite mold for casting daggers, cat. No. 226

<sup>131</sup> Milićević 1984: 12, T.5:1–3.

<sup>132</sup> Schmidt 1945: 141–142, sl. 81A.

<sup>133</sup> Miložić 1949: 88, bilješka 49.

<sup>134</sup> Dimitrijević 1979c: 296.

<sup>135</sup> Durman 1983: 59.

<sup>136</sup> Vinski 1961: 4; Durman 1983: 59.

<sup>137</sup> Dimitrijević 1979c: 290–291.



Sl. 40 dvodijelni kalup za lijevanje dlijeta, kat. br. 228 | Fig. 40 Bipartite mold for casting chisles, cat. No. 228

karakteristične su posude s cilindričnim vratom i ušicama na truhu (amfore), vrčevi s trakastom ručkom kao i kupe (odnosno zdjele) na niskoj i križnoj nozi kao i na cilindričnoj nozi (kao i naš primjerak pod kat. br. 163).<sup>138</sup>

Ukrašavanje je također karakteristično za vučedolsku kulturu: radi se o arhitektonskom stilu, motivi su posloženi u zone, odnosno frizove i metope (kat. br. 50, 64, 65, 81, 90, 91, 93, 94). Aplicirani su geometrijski uzorci, cik-cak motivi (kat. br. 128, 131, 155, 160, 161, 163, 170, 171, 184, 186, 200), kapljičasti ubodi (kat. br. 124, 151, 153–156), trokuti (kat. br. 119) ili rombovi (kat. br. 103, 107, 109, 113, 114, 133, 137), zatim složene kombinacije, kao npr. motiv šahovske ploče (kat. br. 64). Od krivolinijskih motiva karakterističan je motiv rozete ili sunčeva kruga (kat. br. 140, 141, 143–148). Rozete su uglavnom aplicirane na terinama (bikoničnim dubokim zdjelama). Motiv križa, karakterističan za B2 stupanj vučedolske kulture često je apliciran na obrađenim primjercima (kat. br. 52, 53, 64, 121, 123, 137, 150, 158, 164, 171, 173).<sup>139</sup>

Sarvaš se ističe kao jedino naselje vučedolske kulture naseljeno u obje klasične faze (B1 i B2) vučedolske kulture, a sva

functional, so that in the literature another function was examined: that of a blade or knife<sup>136</sup>.

\* \* \*

The shapes that appear at Sarvaš are typical of the phase B1 and B2 of the Vučedol culture. For the phase B1 Dimitrijević mentions the typical shapes of tripartite bottles, wall-hung vessels, censers, bowls with stopper-shaped feet.<sup>137</sup> For the phase B2 typical are vessels with a cylindrical neck and lugs at the belly (amphorae), jars with a band-shaped handle and chalices (i.e. bowls) on a low, cross foot (like our exemplar cat. No. 163).<sup>138</sup>

Decorations are also very typical of the Vučedol culture: it is an architectural style, the motives are placed in zones, i.e. mouldings and metopes (cat. No. 50, 64, 65, 81, 90, 91, 93, 94). Geometrical shapes are applied, zigzag motives (cat. No. 128, 131, 155, 160, 161, 163, 170, 171, 184, 186, 200), tear-shaped stabblings (cat. No. 124, 151, 153–156), triangles (cat. No. 119) or rhombuses (cat. No. 103, 107, 109, 113, 114, 133, 137), then, complex combinations, as for example the chess table motif (cat. No. 64). Among the irregular line motifs typical

<sup>138</sup> Dimitrijević 1979c: 292.

<sup>139</sup> Dimitrijević 1979c: 293.

Predmet

Rekvizit broj

dat.

7878



Fragment posude sa...  
materijal: glina  
sirina: 13,5 mm

7879



Fragment posude...  
materijal: glina  
sirina: 15,8 mm

7880



Fragment posude...  
materijal: glina  
sirina: 10,3 mm

7881



Fragment posude...  
materijal: glina  
sirina: 13,5 mm



7878  
7879  
7880



7878  
7879  
7880

isto

isto

1

7878  
7879  
7880

7885

7886

7887

7888

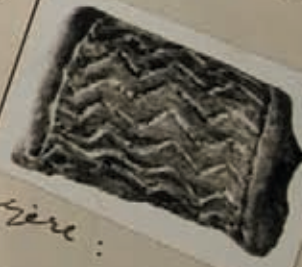

Fragment posude...  
materijal: glina  
sirina: 13,5 mm



Fragment posude...  
materijal: glina  
sirina: 13,5 mm

Sl. 41 Ulomci posuda, Kat. br. 113 i 148  
Fig. 41 Fragments of vessels, cat. No. 113 and 148







ostala naselja pripadaju samo jednom stupnju.<sup>140</sup> Dimitrijević razlog za to vidi u počecima širenja i ekspanzije te kulture prema Baranji, kojoj je Sarvaš bio bliže od Vučedola.

## Ostali nalazi

### Predmeti od keramike

Od svakodnih uporabnih predmeta izdvojili smo nekoliko oblika, od kojih su najučestalije keramičke kuke s jednom ili dvjema rupama za vješanje, čest nalaz u vučedolskim naseljima.<sup>141</sup> Ostali nalazi, kalemovi za predivo i utezi nisu kulturološki relevantni jer se pojavljuju na nalazištima gotovo svih eneolitičkih kultura.<sup>142</sup>

Među građom je nađeno i šest okruglih keramičkih predmeta sa središnjim cjevastim produžetkom otvora. Najvjerojatnije je riječ o modelima kotača kakvi se javljaju u eneolitiku i brončanom dobu.<sup>143</sup> Modeli kola u našim se krajevima pojavljuju s badenskom kulturom,<sup>144</sup> prisutni su u vučedolskoj kulturi,<sup>145</sup> kao i u brončanom dobu.<sup>146</sup>

### Predmeti od bakra

U fundusu Arheološkog muzeja u Zagrebu samo je jedan metalni predmet koji možemo atribuirati razdoblju eneolitika. Za mali bakreni bodež tipa lamele, bez središnjega rebra (kat. br. 229, sl. 43) nemamo bližih podataka o mjestu pronalaska. Najvjerojatnije je dospio u Muzej s ostalom, uglavnom keramičkom građom na početku dvadesetoga stoljeća. Z. Vinski tom bodežu paralele nalazi u primjercima iz Ljubljanskog barja te ga pripisuje vučedolskoj kulturi.<sup>147</sup>

Na nalazištu Vučedol pronađen je dosta sličan bodež, tipa lamele, ali s ostacima rupica za zakovice kojih naš primjerak nema.<sup>148</sup> Bodež je pronađen u sloju koji nedvojbeno pripada nosiocima badenske kulture.

Iako je bez stratigrafskih pokazatelja dosta teško pripisati nalaz određenoj kulturi, skloniji smo njegovoj atribuciji badenskoj kulturi. Tome u prilog ide i nedavno dobiveni rezultat analize metodom röntgenske fluorescencije – EDXRF, koji je potvrdio prisutnost velike količine arsena u bodežu. Sigurnost postojanja badenske metalne produkcije na sarvaškom telu potvrđuje nam i nalaz plosnate bakrene sjekire koja se čuva u Gradskom muzeju u Vukovaru.<sup>149</sup>

### Predmeti od kosti

Iz Sarvaša potječe i velik broj koštanih predmeta, od kojih tek malen broj možemo atribuirati nekoj određenoj kul-

is the rosette or Sun circle (cat. No 140, 141, 143–148). Rosettes are mainly applied to terrines (biconical deep bowls). The cross motif typical of the phase B2 of the Vučedol culture is frequently applied on retouched exemplars (cat. No. 52, 53, 64, 121, 123, 137, 150, 158, 164, 171, 173).<sup>139</sup>

The Sarvaš stands out as the only settlement of the Vučedol culture that was inhabited during both classical phases (B1 and B2) of the Vučedol culture, whereas all other settlements belong to only one phase.<sup>140</sup> Dimitrijević attributes this to the beginnings of the expansion of this culture towards Baranja, to which Sarvaš was closer than Vučedol.

## Remaining finds

### Ceramic artefacts

Among all every-day artefacts we selected few forms, the most frequent among them are ceramic hooks with one or two suspension holes – a frequent find at the Vučedol settlements.<sup>141</sup> The remaining finds, yarn spools and weights are not relevant in terms of culture, since they are found at almost all Eneolithic finding sites<sup>142</sup>

Among the material six round ceramic items have been found with a central, pipe-shaped extension of the opening. Most likely these are types of wheel that appear in the Eneolithic and Bronze Age.<sup>143</sup> Wheel models appear on our territories with the Baden culture,<sup>144</sup> they are present in the Vučedol culture<sup>145</sup> as well as in the Bronze Age.<sup>146</sup>

### Copper artefacts

In the holdings of the Archaeological Museum in Zagreb only one metal artefact can be attributed to the Eneolithic period. There is no detailed information concerning the find location of the small copper lamella-type dagger with no central rib (cat. No. 229, fig. 43). Most likely it reached the Museum with the remaining, mainly ceramic materials, at the beginning of the 20th century. Z. Vinski identified some parallels to the exemplars from the Ljubljansko barje and attributes it to the Vučedol culture.<sup>147</sup>

At the Vučedol site a very similar lamella-type dagger was found but this one presents the remainings of rivet holes that our exemplar lacks.<sup>148</sup> The dagger was found in a layer that undoubtedly belongs to the bearers of the Baden culture.

Although it is very difficult to attribute a find to a certain culture without stratigraphic indicators, we tend to ascribe it to the Baden culture. In favour of this also speaks the recently obtained

<sup>140</sup> Dimitrijević 1979c: 303.

<sup>141</sup> Schmidt 1945: T. 26:15–16, T. 48:14–15; Vinkovci 1999: kat. br. 86.

<sup>142</sup> U ovome radu obradili smo samo one nalaze koje smo sa sigurnošću mogli pripisati razdoblju neolitika ili eneolitika, dok većina pršljenaka iz Sarvaša (41 kom.) može pripadati i mlađim razdobljima, pa smo ih izostavili iz publikacije. Za kalemove vidi: Petrović & Jovanović 2002: 30, kat. br. 22 (badenska kultura), Schmidt 1945: T. 48:11–13 (vučedolska kultura). Za piramidalne utege vidi: Petrović & Jovanović 2002: 42, kat. br. 6 (badenska kultura); Petrović & Jovanović 2002: 105, kat. br. 5 (kostolačka kultura).

<sup>143</sup> Marković 2002: 34 s navedenim analogijama.

<sup>144</sup> Najpoznatiji primjerci kola u badenskoj kulturi potječu iz Mađarske, vidi: Banner 1956: 127; Kalicz 1976. Na Vučedolu su pronađena dva dijela keramičkog modela kola, vidi: Težak–Gregl 1988: 13.

<sup>145</sup> Vučedol 1988: kat. br. 24.

<sup>146</sup> Bondar 1995: 216–217; Machnik 1991: sl. 8.

<sup>147</sup> Vinski 1961: 5.

<sup>148</sup> Težak–Gregl 1987: 74, u navedenom radu navode se analogije tom tipu bodeža pa ih ovdje nećemo ponavljati.

<sup>149</sup> Simbol 2006: kat. br. 18.



Sl. 43 bodež, kat. br. 229 | Fig. 43 Dagger, cat. No. 229

result of the EDXRF analysis, which confirmed the presence of large quantities of arsenic in the dagger. The existence of Baden metal production at the Sarvaš tell is confirmed by the find of a flat copper axe stored in the Municipal Museum of Vukovar.<sup>149</sup>

#### Bone artefacts

A large number of stone artefacts originate from Sarvaš. Unfortunately, only a small number of them can be attributed to a certain culture. Bone tools can basically be divided into two groups<sup>150</sup>

- a. tools of antler (cat. No. 246, 250–252)
- b. fine manufactured bone items: spatulas, awls and harpoons.

Due to their large number, horn hoes with a hole for placing the handle undoubtedly stand out (cat. No. 237–244), as well as fine manufactured bone harpoons (cat. No. 230–235).

With certainty we can ascribe to the Vučedol culture the find of the tool with cogs on one side made of the scoop of animal bone (cat. No. 245), likewise the harpoons,<sup>151</sup> whereas the hoes,<sup>152</sup> awls (cat. No. 249, 253–255) and spatulas (cat. No. 247, 248, 258) are the typical find of almost all listed cultures.

#### Stone artefacts

Stone, wood and bone are gifts from nature that the prehistoric man availed of from his beginnings. Stone as well as bone arte-



Sl. 44 sjekira s rupom za nasad, kat. br. 236 | Fig. 44 Axe with a mace hole, cat. No. 236

turi. Alatkke od kosti u osnovi možemo podijeliti na dvije grupe:<sup>150</sup>

- a. alatkke od jelenjih rogova ili parožaka (kat. br. 246, 250–252)
- b. fino izrađeni koštani predmeti: spatule, šila i harpuni.

Svojom brojnošću svakako se izdvajaju motike od roga s rupom za nasad drške (kat. br. 237–244) te fino obrađeni koštani harpuni (kat. br. 230–235).

Vučedolskoj kulturi sa sigurnošću možemo pripisati nalaz alatkke s nazubljenjima na jednom rubu izrađene od lopatice životinjske kosti (kat. br. 245) kao i harpune,<sup>151</sup> dok su motike,<sup>152</sup> šila (kat. br. 249, 253–255) i spatule (kat. br. 247, 248, 258) karakterističan nalaz gotovo svih u radu navedenih kultura.

### Predmeti od kamena

Kamen, drvo i kost darovi su prirode koje je pretpovijesni čovjek imao na raspolaganju od svojih početaka. Međutim predmete izrađene od kamena i kosti ne možemo točno kulturološki odrediti. Kamen je zahvaljujući svojim svojstvima najvažniji i najtrajniji, pa je i ostao kao siguran pokazatelj ljudske djelatnosti kroz prošlost. Kameni predmeti svrsishodni su proizvodi te su gotovo u svim neolitičkim i eneolitičkim kulturama zastupljeni isti tipovi.<sup>153</sup>

Među građom iz Sarvaša uglavnom su zastupljene alatkke, pa smo samo dva predmeta mogli atribuirati u nakit (kat. br. 260–261). Kamene perle zabilježene su, iako u dosta skromnom broju, od razdoblja neolitika.<sup>154</sup>

Ostali kameni proizvodi podijeljeni su u tri grupe:

- a. alatkke obrađene glačanjem (kat. br. 262–268),
- b. alatkke obrađene brušenjem (kat. br. 269–270),
- c. cijepane alatkke (kat. br. 271–296).<sup>155</sup>

Od alatki obrađenih glačanjem najzastupljenije su sjekire s rupom za nasad (kat. br. 262–265, 267). Dvije sjekire sa središnjim zadebljanjem (kat. br. 262 i 264) najvjerojatnije pripadaju tipu bojnih sjekira.<sup>156</sup> Taj karakteristični oblik čest je u bakrenom dobu, kada se javlja i u grobovima, npr. u Crnoj Gori,<sup>157</sup> ili u Varni, gdje su osim kamenih, u bogatim kneževskim grobovima, prilagani i tipološki isti bakreni primjerci.<sup>158</sup>

Od alatki pak obrađenih brušenjem najzastupljeniji je rastirač, alatka okrugla ili gotovo četvrtasta oblika, koja je služila za usitnjavanje plodova, žita i pigmenata (kat. br. 269–270).<sup>159</sup>

Cijepana litička građa u najvećem se broju odnosi na odbojke, sječiva i jezgre. Od alatki najčešće su zastupljena grebala, a na nekoliko je sječiva ustanovljeno postojanje sjaja na rubu (kat. br. 292, 295), što nam potvrđuje da je alatka korištena pri rezanju bilja ili nekog drugog organskog materijala. Upotrebljavani kamen uglavnom je rožnjak, tamnocrvene ili tamnosive boje.

facts cannot be defined in terms of culture. Stone is however thanks to its features the most important and most durable and has therefore remained as a manifest indicator of the human activity across the past centuries. Stone artefacts always had a purpose. Therefore, the same types are present in almost all Neolithic and Eneolithic cultures.<sup>153</sup>

In the Sarvaš material tools are mainly represented, so that only two items could be defined as jewellery (cat. No. 260-261). Stone pearls are registered, although in a very modest amount, from the Neolithic period onwards.<sup>154</sup>

The remaining stone products are divided into three groups:

- a. tools made by polishing (cat. No. 262–268),
- b. tools made by grinding (cat. No. 269–270),
- c. chipped tools (cat. No. 271–296).<sup>155</sup>

Among the polished tools the most frequent are shaft hole axes (cat. No. 262–265, 267). Two axes with a central thickening (cat. No. 262 and 264) most likely belong to the type of battle axes.<sup>156</sup> This characteristic shape is frequent in the Copper Age, when it appears also in graves in Montenegro<sup>157</sup> or in Varna in Bulgaria, where beside stone axes, in the rich dukes' graves the same typological copper exemplars are found.<sup>158</sup>

Among the grinding tools the most frequent is the hammerstone, a tool of a round or almost square shape that was used for chopping fruits, wheat and pigments (cat. No. 269–270).<sup>159</sup>

The chipped material refers to a largest degree to flakes, blades and cores. Among the tools the most frequently represented are endscrapers. The existence of edge gloss was identified on some blades (cat.No. 292, 295), which means that the tool was used for cutting plants or some other organic material. The stone used is mainly chert, dark red or dark grey.

<sup>150</sup> Kao primjer tipologije alatki od kosti i roga navodimo Perišić 1984: 29–50.

<sup>151</sup> Dimitrijević 1979c: 296.

<sup>152</sup> Kao neke od primjera analogija za motike navodimo: Baden Culture 2004: kat. br. 62–63 (badenska kultura); Petrović & Jovanović 2002: 278 (kostolačka kultura); Vučedol 1988. kat. br. 5–6; Vinkovci 1999: kat. br. 88 (vučedolska kultura).

<sup>153</sup> Za tipologiju glačanih kamenih alatki vidi: Antonović 2003: 52–69; Karavanić & Balen 2003: 50; za tipologiju cijepanih alatki vidi: Šošić & Karavanić 2005: 23–25.

<sup>154</sup> Antonović 2003: 67, sl. 46:8,9

<sup>155</sup> Za razlikovanje brušenja od glačanja vidi: Karavanić & Balen 2003: 19,54.

<sup>156</sup> Balen-Letunić 1981: 9.

<sup>157</sup> Saveljić Bulatović & Lutovac 2003: kat. br. 6.2 (lokalitet Tološi – Boljevića Gruda)

<sup>158</sup> Kao primjer navodimo grob 43, vidi: Ivanov & Nikolov 1986: kat. br. 327, 335.

<sup>159</sup> Ovdje su objavljena samo dva primjerka, a čuva ih se šest.

## Zaključak

U ovome radu predstavljena su 303 predmeta (301 katalogska jedinica) prikupljena za Arheološki muzej u Zagrebu u prvoj polovici 20. st. Osnovu sarvaškog fundusa čini građa prikupljena tijekom iskopavanja R. R. Schmidta 1942. – 1943. godine, ali je zastupljena i građa sakupljena prilikom obrađivanja zemlje, koju je Muzej dobio ili kupio od lokalnoga stanovništva. Bez jasnog arheološkoga konteksta proučavanje ove građe bilo je dosta otežano. Obradena je isključivo građa koja je tipološki i kulturološki određiva te pripada razdoblju mlađega kamenog doba (neolitika) i bakrenoga doba (eneolitika). Kako je riječ o građi kojoj je nepoznato mjesto nalaženja, ili kao u slučaju Schmidtovih iskopavanja, kada nema sačuvane dokumentacije, materijal smo mogli samo katalogski obraditi.

Nalazi iz Sarvaša koji se čuvaju u Arheološkome muzeju u Zagrebu su najvećim dijelom keramički. Tipološki je zastupljen dosta raznovrstan materijal, posebice iz razdoblja eneolitika, poglavito vučedolske kulture. Predmeti od kamena i kosti zastupljeni su u manjoj mjeri, jer je za tu vrstu nalaza bez poznavanja stratigrafske pozicije dosta teško odrediti kulturnu pripadnost. Obraden je također i jedan metalni predmet.

Sarvaš je višeslojan lokalitet tel tipa naseljen tijekom pretpovijesti, a kulturni mu sloj, na nekim mjestima, doseže dubinu do 6 metara, čime se po sadašnjem stanju istraživanja, iskazuje kao puno veći od Vučedola. Oba ta umjetno stvorena brežuljka nastala su neprekidnim naseljavanjem te su bili središta društvenoga i ekonomskoga života, važna u strateškom i komunikacijskom smislu.

Stratigrafija Sarvaša uvelike se poklapa sa stratigrafijom Vučedela, uz iznimku sopotskoga sloja, koji na Vučedolu do sada nije ustanovljen. Na Sarvašu se može gotovo neprekinuto pratiti život od ranoga neolitika. Ustanovljeni slijed kultura kreće od neolitičkih: starčevačke i sopotske, eneolitičkih: badenske, kostolačke i vučedolske te brončanodobnih kultura: vinkovačke i belegiš II kulture. Nalazi latenske, rimske i srednjovjekovne keramike ponovno nam potvrđuju strateški važan i povoljan položaj Sarvaša.

Iako nam je građa iz Arheološkoga muzeja u Zagrebu predstavila neke nove i do sada nepoznate oblike, tu pogavito mislimo na neolitičke nalaze objavljene pod kat. br. 4 i 5 te keramičke oblike kojima smo nesumnjivo upotpunili tipološku sliku eneolitičkih kultura, naročito vučedolske,

## Conclusion

In this work 303 artefacts (301 cat. Numbers) are presented that have been collected for the Archaeological Museum in Zagreb in the first half of the 20<sup>th</sup> century. The base of the Sarvaš holdings is made up by the materials gathered in the course of the excavations by R.R. Schmidt from 1942 – 1943. The material received or acquired by the Museum from the local population during earth cultivation is also presented. The analysis of the material was made significantly difficult by the lack of a clear archaeological context. Therefore, only the materials that could typologically and culturally be identified and belonging to the earlier Stone Age (Neolithic) and the Copper Age (Eneolithic) were analysed. Since the materials concerned have no precise find location, or as the case of Schmidt's excavations, have no preserved documentation, the materials could be analysed only in a catalogue.

The Sarvaš finds stored in the Archaeological Museum in Zagreb offered to a large degree various ceramic finds. From the typological point of view, very differentiated material is available, especially from the Eneolithic period and particularly of the Vučedol culture. Stone and bone artefacts are represented in a smaller degree in this work due to the fact that for such kinds of findings it is very difficult to state the cultural belonging without knowing the stratigraphic position. One metal artefact has also been analysed.

The Sarvaš site is a multilayer site of the »tell« type, settled in prehistoric times, and its cultural layer, on some places reaches up to 6 meters, whereby it proves to be much larger than Vučedol, according to the current research status. Both of these two artificially created hills originated from continuous settlements and thus represented the centres of the social and economic life, were important in terms of strategic value and communication.

The Sarvaš stratigraphy significantly overlaps with the Vučedol stratigraphy, with the exception of the Sopot layer, which has not been identified at Vučedol. At the Sarvaš site it is possible to almost uninterruptedly follow the life from the early Neolithic. The identified succession of cultures goes from the Neolithic ones: Starčevo and Sopot cultures, Eneolithic ones: the Baden, Kostolac and Vučedol cultures, thereafter the Bronze Age cultures of Vinkovci and Belegiš II. The finds of Roman and Middle Age pottery corroborate the strategic importance and favourable location of the Sarvaš.

Although the materials from the Archaeological Museum of Zagreb revealed some new and until now unknown shapes – in



Handwritten notes on a document, including a table with columns and rows of text. The text is in a cursive script, likely a historical or scientific record. The document is partially covered by the ceramic vessels and a black surface.

943.	Sarvas	neuphara	poruda
	neorua	lucitana	na
	delnon	neibou	
944.	Sarvas	neuphara	poruda
	neorua	lucitana	na
	delnon	neibou	
945.	Sarvas	neuphara	poruda
	neorua	lucitana	na
	delnon	neibou	
946.	Sarvas	neuphara	poruda
	neorua	lucitana	na
	delnon	neibou	

čijih je nalaza u najvećem broju, moramo zaključiti da je bilo nemoguće izvršiti reviziju stratigrafije Schmidtovih iskopavanja. Na žalost, čak i sa signiranim materijalom (navedene su dubine i kvadranti), u stratigrafskom smislu oni ništa ne znače, jer zbog uleknuća slojeva te naročito zbog ukopanih objekata (na materijalu nema oznaka jama) same dubine ne odražavaju stratigrafiju i kulturni sloj različitih faza naseljavanja Sarvaša. Tako je npr. u kvadrantu A na dubini od 7,20 m pronađena sopotska posuda, dok su u kvadrantu B na 5,60 m ustanovljeni starčevački nalazi. Postojanje jama sugerira nam i podatak da je na sličnim dubinama, npr. na 5,80 m relativne dubine u kvadrantu 8, u kvadrantu 23 na 5,90 m ili recimo u kvadrantu 24 na 5,70 m ustanovljen vučedolski materijal. U kvadrantima 15 i 20 na istim se dubinama pojavljuju vučedolski i kasnobrončanodobni materijal.<sup>160</sup>

Usprkos svim tim objektivnim teškoćama u interpretaciji nalaza, kronološka pozicija kultura koje su naseljavale Sarvaš dosta nam je dobro poznata. Na osnovi objavljenoga materijala možda će se ipak morati računati s dužim trajanjem sopotske kulture, kao i s jednom starijom fazom naseljavanja u razdoblju eneolitika od badenske kulture, odnosno s Boleráz horizontom.

U svakom slučaju, tek će nam objava cjelokupne građe iz Schmidtovih iskopavanja – neolitički i eneolitički materijal koji se čuva u Muzeju Slavonije u Osijeku, ako izuzmemo nekoliko posuda objavljenih u katalozima, nije objavljen – pružiti potpuni uvid, što ovo iznimno nalazište i zaslužuje.

particular the Neolithic finds published under catalogue number 4 and 5 and the ceramic forms that undoubtedly completed the typological picture of Eneolithic cultures, especially the Vučedol culture, whose finds are most numerous – we have to conclude that it was impossible to review the stratigraphy of the excavations by Schmidt. Unfortunately, even classified materials (the depths and quadrants are stated) do not mean much in the stratigraphic sense, since due to the waver of layers and especially due to the ditched objects (on the material there are no signs of pits) only depths do not reflect the stratigraphy and the cultural layer of the different phases of settling Sarvaš. For example in the quadrant A at the depth of 7,20 m a Sopot vessel was found, whereas in the quadrants B at 5,60 m Starčevo finds were identified. The existence of pits is suggested by the fact that at similar depths, e.g. at the depth of 5,80 m in quadrant 8, in quadrant 23 at the depth of 5,90 m or in quadrant 24 at 5,70 m Vučedol materials were found. In the quadrants 15 and 20 at the same depths the Vučedol and Late Bronze Age material was identified.<sup>160</sup>

In spite of the objective difficulties in the interpretation of finds, the chronological position of cultures inhabiting Sarvaš is well known. On the basis of the published material we may need to assume a longer duration of the Sopot culture as well as an earlier phase of settlement of the Baden culture, i.e. the Boleráz horizon in the Eneolithic period.

In any case, only the publication of the whole material from Schmidt's excavations – the Neolithic and Eneolithic material stored in the Museum of Slavonia in Osijek, has not been published yet if we exclude a few vessels published in catalogues – will offer a complete insight, which this exceptional finding site deserves.

<sup>160</sup> Pri iznošenju navedenih podataka veliku korist imali smo od već ranije spomenute kartoteke koja se čuva u AMZ-u (na karticama se uz fotografiju pojedinog iskopanog predmeta navode dubina, kvadrant te dimenzije) što nam je omogućilo usporedbu građe koja se čuva u zagrebačkom i osječkom muzeju. Ipak, moramo naglasiti i nedostatak pri interpretaciji građe putem fotografija – na taj smo način mogli prepoznati samo tipične, uglavnom ukrašene primjerke.

Appendix – English translation of the footnotes

- 1 Geografija 1975: 123.
- 2 Geografija 1975: 11.
- 3 Geografija 1975: 43–44.
- 4 Victor 1870; Celestin 1897.
- 5 Schmidt 1945.
- 6 Vinski 1955; Vinski-Gasparini 1956.
- 7 Dimitrijević 1966.
- 8 Minichreiter 1991.
- 9 For a detailed list of excavations see Marković 1994: 11–13.
- 10 Minichreiter 2005: 25.
- 11 Krznarić-Škrivanko 2003.
- 12 Durman et al. 2003: 46–50.
- 13 Minichreiter 1992a (Starčevo culture); Težak-Gregl 1993 (culture of linear band-shaped pottery).
- 14 Marković 1994; Težak-Gregl 1998.
- 15 Čečuk & Radić 2005 (Vela Spila); Marijanović 2005 (Gudnja).
- 16 Due to the given reasons we decided to rank the materials in the Catalogue at the end of the monograph according to the cultural affiliation, the type of material and typology, and not as usually done according to the stratigraphic units. The materials from Schmidt's excavations, contain along with the inventory number also the quadrant and the depth, i.e. all information available to us.
- 17 Hoernes 1901:276; Wosinsky 1904: 43, 44; Hoernes & Menghin 1925: 340, 764; Childe 1929: 210.; Schuchhardt 1926: 153.; Reinecke 1897: 78
- 18 Often peasants sold the found materials outside the national border. A letter stored at the archives of the Archaeological Museum in Zagreb (hereafter AMZ) bears witness to that occurrence dating 1906, addressed to Karl Penzinger and containing the prohibition of selling materials abroad (No. 27/1906).
- 19 Hoffiller 1938.
- 20 Bosendorfer 1942: 17
- 21 Šimić 1991: 6.
- 22 Schmidt 1945: 127–131.
- 23 Grubišić 2002: 117–130.
- 24 Quadrants were marked with numbers from 1 to 25 and with letters A and B, whereas one quadrant had the mark 10 A.
- 25 Grubišić 2002: 126–127.
- 26 Dimitrijević 1968: 26; Dimitrijević 1969: 68, note 13.
- 27 Schmidt 1945: 127–131, 141–142, 145–146.
- 28 Miložić 1949: 82–90.
- 29 Archives AMZ, No. 261/1943.
- 30 Dimitrijević 1968: 26–27.
- 31 Dimitrijević published also a profile drawing of the given blocks, i.e. quadrants, see Dimitrijević 1971: fig. 2
- 32 Archives AMZ, 29.10.1945., No. 210/1945.
- 33 Grubišić 2002: 119–120.
- 34 Garašanin 1951: 79–80; Tasić 1967: 22, 61; Tasić 1970: 26; Tasić 1984: 33–34; Parzinger 1993: 20; Marković 1993: fig. 5:5; Marković 1994: 17, 239 (fig. 7B), 241 (fig. 9A).
- 35 Šimić 1991: 7.
- 36 Šimić 1986a: 23–24; Šimić 1986b: 37–38; Šimić 1987: 64–65.
- 37 Šimić 1991: 10–35; Šimić 1992: 31–48; Šimić 1993: 127–148; Šimić 2000: 122, in these editions the materials from Schmidt's excavations has been published
- 38 In the letter stored at the AMZ archives (No. 75/1900) Đ. Schäffer gives information about the circumstances of the finding: items of the Vučedol culture (cat. No. 73, 100) were found at 2–3 m of relative depth, and wheat at 4 m, quotation „on a four fingers thick and three meters long stretching sediment.«
- 39 Gubišić 2002: 130.
- 40 Dizdar & Krznarić-Škrivanko 2000: 9–10.
- 41 Minichreiter 1992a, 29–35 (Zadubravlje, explored 6200 m2); Krznarić-Škrivanko 1999, 11 (tell Vinkovci, explored 11 614 m2); Minichreiter 2005: 25–30 (Galovo, explored 2200 m2).
- 42 Schmidt 1945: 129.
- 43 Dimitrijević 1969: 15.
- 44 Schmidt mentions „neolithische siedlung mit grubenhäuser« see Schmidt 1945: 129.
- 45 Schmidt 1945: fig. 74, 74 A. Vessel on fig. 74:2 does not represent a typical Starčevo shape and belongs to the later period (the find is stored at the Museum of Slavonia in Osijek). The find on fig. 74:6 belongs to the Sopot culture and will be analysed in the following chapter.
- 46 Dimitrijević 1969b: T. 1:2; Dimitrijević 1974: T. IV:6–10; Minichreiter 1992a: 21, 22, T.10, fig. 21:1,8,9; Marković 1994: T.1:4–7.
- 47 Arandelović-Garašanin 1954: 8, 16, 18, 25, 45, 133.
- 48 Šimić 1995: 9, cat. No. 2.1; Težak-Gregl 1998: 72, fig. 6; Minichreiter 2000: fig. 3; only few of the latest publications have been taken for illustration purposes.
- 49 Minichreiter 2000.
- 50 Schmidt 1945: T.74:3.
- 51 Minichreiter 1992b: 10.; Težak-Gregl 2003. The opinion of some authors has to pointed out here, according to which this shape might belong to the Vučedol culture, see Milićević Bradač 2005: 191, fig. 12.
- 52 In the Catalogue for coarse pottery the term »poorly polished and uneven surface« was used, whereas the fine pottery was graded form: »matte surface« (mainly polished, with no gloss), »partly polished« (signs of polishing are visible) and »polished surface« (taken over from Vrdoljak 1994: 14).
- 53 Some of the shapes are in fact characteristic for the whole Neolithic period and appear in few Neolithic cultures. Since we do not avail of the stratigraphic context the items were attributed according to the manufacturing to the Starčevo culture, although we do not exclude then possibility of them being ascribed to the early Sopot culture (this particularly refers to the items cat. No. 4 and 5).
- 54 Perić 1995: T. XXXV:5.
- 55 Vasić 1936: T. XXIII:55.
- 56 Makkay et al. 1996: fig. 18:11.
- 57 Makkay 1987: fig. 2:1–7, 10.
- 58 Barna 2001: T. 1:3.
- 59 Karmanski 2005: T. LXX, LXXV:2.
- 60 Dimitrijević 1968: 27.
- 61 Dimitrijević 1974: T. IV:6–10; Dimitrijević 1979a: 246; Marković 1994: 71.
- 62 Minichreiter 1992a: 22; Minichreiter 1997: 21–22.
- 63 Schmidt 1945: 129.
- 64 Miložić 1949: 82.
- 65 Dimitrijević 1968: 27.
- 66 Dimitrijević 1969b: 52; Dimitrijević 1979a: 265.
- 67 Dimitrijević 1979a: 270–273.
- 68 Krznarić-Škrivanko 1997.
- 69 The given finds are stored at the AMZ, the figure was taken from the earlier mentioned card files. For weight finds at Sopot objects see: Krznarić-Škrivanko 2003: 65.
- 70 Balen-Letunić 1982: 71.
- 71 Hoffiller 1938: T.2:1.
- 72 Eibner 1973; Balen-Letunić 1982: 72.
- 73 Dimitrijević 1968: 42–43.
- 74 Exemplar similar to a small, biconical pot, cat. No. 7 is from Otok, see Dimitrijević 1968: T. V:7.
- 75 Dimitrijević 1968: fig. 8:22–23.
- 76 Schmidt 1945: 129, 141; Miložić 1949: 82.
- 77 Dimitrijević 1968: 27.
- 78 Dimitrijević 1979b: 199.
- 79 Dimitrijević 1979b: 212.
- 80 Tasić 1979: 249; Nikolić 2000: 42–43; Balen 2002b: 44.
- 81 Balen 2004: 66.
- 82 Banner already inserted it on the chart where the Baden culture stretched 1956: 136.

- <sup>83</sup> Dimitrijević 1979b: T. XXII:9, Marković 1994: T. 28:4–5; Težak-Gregl 1998: fig. 43, 45. In the literature one more bowl has been published (Dimitrijević 1979b: T.XXIII: 10, Marković 1994: T. 29:6), it is however a find from Vučedol, from Schmidt's excavations (see Schmidt 1945: T. 23: 6). Hoffiller also published a few items but did not attribute them to the Baden culture. From the Museum of Slavonia in Osijek one bowl of the Baden culture from Schmidt's excavations has been published, (see: Šimić 1995: cat. No. 4.9, without a photo).
- <sup>84</sup> Dimitrijević 1979b: 214.
- <sup>85</sup> Dimitrijević 1979b: 206.
- <sup>86</sup> Tasić 1984: 31–32; Tasić 2001; Garašanin 2001.
- <sup>87</sup> Tasić 2001: 344–345.
- <sup>88</sup> Petrović & Jovanović 2002: 60, 64–69.
- <sup>89</sup> Schmidt 1945: 127–131, 184–185.
- <sup>90</sup> Milojčić 1943: 41–54.
- <sup>91</sup> Milojčić 1953: 151–157.
- <sup>92</sup> Dimitrijević 1968: 26–27.
- <sup>93</sup> Hoffiller 1938: T. 9.
- <sup>94</sup> Tasić 1979: 249; Nikolić 2000: 42–43; Balen 2002b: 44.
- <sup>95</sup> Nikolić 2000: T. XXXIX:1–4.
- <sup>96</sup> Tasić 1979: 254; Nikolić 2000: 49 (type II), T.XXXIX:8; Petrović & Jovanović 2002: 228 (types 5 and 6).
- <sup>97</sup> Dimitrijević 1979: T. XXVII:3.
- <sup>98</sup> To this kind of vessel also the body fragments belong, respectively of the lower section or rounded base that have not been reproduced here, see Hoffiller 1938: T. 9:6–8,10; Balen 2002a: T. 4:5–6.
- <sup>99</sup> Balen 2002a: T. 8:2.
- <sup>100</sup> Marković 1994: T. 31:5.
- <sup>101</sup> Petrović & Jovanović 2002: 228 (type 1 and 2).
- <sup>102</sup> Petrović & Jovanović 2002: 228 (cup type 1)
- <sup>103</sup> Unpublished material from systematic excavations at the Streim vineyard
- <sup>104</sup> Petrović & Jovanović 2002: 105 (cat. No. 4)
- <sup>105</sup> Durman 1995.
- <sup>106</sup> Schmidt 1945: 129, 145–146.
- <sup>107</sup> Dimitrijević 1968: 27.
- <sup>108</sup> Šimić 1986a: 24.
- <sup>109</sup> From the Museum of Slavonia in Osijek a few items have been published, mainly vessels of the Vučedol culture from Schmidt's excavations, see: J. Šimić 1995: cat. No. 3.3–3.7, 3.10–3.16, 4.13, 6.4; same 1997: cat. No. 23–26.
- <sup>110</sup> In the literature this item is often referred to as pear-shaped vase, see: Dimitrijević 1956: 18. For some of the analogies see: Orion 2000: at. No. 5,6,27
- <sup>111</sup> An almost identical small vessel originates from Vučedol, see: Orion 2000: cat. No. 11.
- <sup>112</sup> Šimić 1997: 18, cat. No. 3.12 (a smaller terrine with decorated lower section from the holdings of the Museum of Slavonia in Osijek)
- <sup>113</sup> The same type is present also at Vučedol, see Schmidt 1945: T. 33:6, T. 34:1.
- <sup>114</sup> Among the here analysed material only the type with a short neck is present, for analogies see: Orion 2000: cat. No. 7,57. For vessel exemplars with a long, cylindrical neck see: Dimitrijević 1979c: T. XXVIII:6, T.XXX:1,3,8.
- <sup>115</sup> At the Vučedol finding sites two varieties of this type have been identified, the S-profiled bowl and the shallow, square bowl, see: Orion 2000: cat. No. 23, cat. No. 24. The shallow, square bowl is considered to have been used for cult purposes, see: Težak 1975: 10–11.
- <sup>116</sup> Orion 2000: cat. No. 22, 35, 36, 40.
- <sup>117</sup> Bipartite bottle originates from Stari Mikanovci, see: Vučedol 1988: cat. No. 47.
- <sup>118</sup> Found at Vučedol, position Gradac: Schmidt 1945: T.42:1; Dimitrijević 1979c: T. XXIX: 6; position Streim vineyard: Vučedol 1988: cat. No. 11–13; in Vinkovci: Vučedol 1988: cat. No. 14.
- <sup>119</sup> The same shape is known also from Vučedol, see: Schmidt 1945: T. 42:5–7.
- <sup>120</sup> For Vučedol see: Schmidt 1945: T. 42:9; for Vinkovci: Vučedol 1988: cat. No. 190.
- <sup>121</sup> Schmidt 1945: T. 43:2–3; Dimitrijević 1956: 20.
- <sup>122</sup> In the Sarvaš card files and in the inventory museum books these finds are listed as funnels.
- <sup>123</sup> Saveljić Bulatović & Lutovac 2003: 31, cat. No. 6.4.
- <sup>124</sup> Vučedol 1988: cat. No. 187–189 (finding sites Vinkovci, Stari Mikanovci, Vučedol).
- <sup>125</sup> Dimitrijević 1956: 17.
- <sup>126</sup> Dimitrijević 1979c: 294; Miličević 1988: 30; Hoti 1990.
- <sup>127</sup> Stored in the Museum of Slavonia in Osijek, see: Dimitrijević 1979c: T. XXXIV:1.
- <sup>128</sup> Schmidt 1945: T. 51:2; Dimitrijević 1979c: T. XXXIV:2; Težak 1975: fig. 6–13, 19–20.
- <sup>129</sup> Bosendorfer 1942: 20.
- <sup>130</sup> Težak 1975: 12.
- <sup>131</sup> Miličević 1984: 12, T.5:1–3.
- <sup>132</sup> Schmidt 1945: 141–142, fig. 81A.
- <sup>133</sup> Milojčić 1949: 88, note 49.
- <sup>134</sup> Dimitrijević 1979c: 296.
- <sup>135</sup> Durman 1983: 59.
- <sup>136</sup> Vinski 1961: 4; Durman 1983: 59.
- <sup>137</sup> Dimitrijević 1979c: 290–291.
- <sup>138</sup> Dimitrijević 1979c: 292.
- <sup>139</sup> Dimitrijević 1979c: 293.
- <sup>140</sup> Dimitrijević 1979c: 303.
- <sup>141</sup> Schmidt 1945: T. 26:15–16, T. 48:14–15; Vinkovci 1999: cat. No. 86.
- <sup>142</sup> In this work only those items have been analysed that could with certainty be attributed to the Neolithic or the Eneolithic period, whereas the majority of vertebrae from Sarvaš (41 pieces) may belong also to younger periods so they were left out from the publication. For spoils see: Petrović & Jovanović 2002: 30, cat. No. 22 (Baden culture), Schmidt 1945: T. 48:11–13 (Vučedol culture). For pyramid-shaped weights see: Petrović & Jovanović 2002: 42, cat. No. 6 (Baden culture); Petrović & Jovanović 2002: 105, cat. No. 5 (Kostolac culture).
- <sup>143</sup> Marković 2002: 34 with the given analogies.
- <sup>144</sup> The best known exemplars of wheel in the Baden culture originate from Hungary, see: Banner 1956: 127; Kalicz 1976. At Vučedol two parts of a ceramic wheel model were found, see: Težak-Gregl 1988: 13.
- <sup>145</sup> Vučedol 1988: cat. No. 24.
- <sup>146</sup> Bondar 1995: 216–217; Machnik 1991: fig. 8.
- <sup>147</sup> Vinski 1961: 5.
- <sup>148</sup> Težak-Gregl 1987: 74, in the given work the analogies are mentioned to this type of dagger so they will not be repeated here.
- <sup>149</sup> Symbol of god and king 2006: cat. No. 18.
- <sup>150</sup> As an example of the typology of bone and horn tools see: Perišić 1984: 29–50.
- <sup>151</sup> Dimitrijević 1979c: 296.
- <sup>152</sup> For some examples of analogies for hoes see: Baden Culture 2004: cat. No. 62–63 (Baden culture); Petrović & Jovanović 2002: 278 (Kostolac culture); Vučedol 1988. cat. NO. 5–6; Vinkovci 1999: cat. No. 88 (Vučedol culture).
- <sup>153</sup> For the typology of polished stone tools see: Antonović 2003: 52–69; Karavanić & Balen 2003: 50; for the typology of chipped tools see: Šošić & Karavanić 2005: 23–25.
- <sup>154</sup> Antonović 2003: 67, fig. 46:8,9
- <sup>155</sup> For a differentiation between grinding and polishing see: Karavanić & Balen 2003: 19,54.
- <sup>156</sup> Balen-Letunić 1981: 9.
- <sup>157</sup> Saveljić Bulatović & Lutovac 2003: cat. No. 6.2 (finding site Tološi – Boljevića Gruda).
- <sup>158</sup> As an example the grave 43 is mentioned, see: Ivanov & Nikolov 1986: cat. No. 327, 335.
- <sup>159</sup> Only two exemplars are published here, whereas six are stored.
- <sup>160</sup> At conveying the given information we very much used the earlier mentioned card files stored at the AMZ (in the cards beside the photograph of the single excavated item also the depth, quadrant and dimensions are given). This allowed us to compare the materials stored at the Zagreb and the Osijek museums. However, we have to point out the shortcoming of interpreting the materials based on photographs – in this way only typical, mainly decorated exemplars could be recognized.





# Katalog | Catalogue

---

Kratice korištene u katalogu predmeta: kv. – kvadrant, dub. – dubina, ø – promjer, deblj. – debljina, vis – visina.

Abbreviations used in the Catalogue  
q. – quadrant, ht – hight

## Katalog

1. inv. 7914, kv. A, dub. 5,40  
Lonac zaobljena tijela i cilindrična vrata. Ukrašen barbotinom, svijetlosmeđe boje. Na trbuhu i pri dnu posude nalazi se pet parova plastičnih izbočina.  
Dimenzije: vis. 42,6 cm,  $\varnothing$  ruba 30 cm,  $\varnothing$  dna 13,2 cm, deblj. stijenke 1,2 cm  
Lit.: Schmidt 1945: sl. 74:1; Minichreiter 1992a: sl. 21:1; Die Neandertaler 1994: 111, kat. br. N 2 (krivo su napisani inventarni broj i nalazište)
- 2 inv. 16933, kv. A-B, dub. 4,80  
Lonac S-profilirana tijela s četirima ušicama na trbuhu te s prstenastom nogom. Crvene boje, slabo zaglađene i neravne površine.  
Dimenzije:  $\varnothing$  ruba 7,8 cm,  $\varnothing$  dna 6 cm, vis. 9,8 cm, deblj. stijenke 0,5 cm.  
Lit.: Schmidt 1945: sl. 74:5; Dimitrijević 1969a: T. 2:2; Dimitrijević 1974: T. IV:10; Minichreiter 1992a: sl. 21:9.
3. inv. 20369, kv. 14, dub. 4,50  
Zaobljen lončić ravna dna. Sive boje, neravne, slabo zaglađene površine, djelomično rekonstruiran.  
Dimenzije:  $\varnothing$  ruba 5,5 cm, vis. 8,4 cm, promjer dna 4,5 cm, deblj. stijenke 0,5 cm
4. inv. 4937 (sl. 20)  
Zaobljena kupa na nozi. Dno noge izvedeno je u 5 krakova (jedan je oštećen). Žučkasto-sive boje, glatke, mat površine.  
Dimenzije:  $\varnothing$  ruba 5 cm, vis. 5 cm, deblj. stijenke 0,5 cm,  $\varnothing$  noge 4,5 cm  
Lit.: Hoffiller 1938: T. 2:4
5. inv. 7907, kv. 19, dub. 4,00  
Konična plitka kupa na nozi. Dno noge račva se u 10 krakova. Žutosmeđe boje, slabo zaglađene i neravne površine.  
Dimenzije:  $\varnothing$  ruba 5,7 cm, vis. 4,2 cm,  $\varnothing$  noge 5 cm, deblj. stijenke 0,5 cm
6. inv. 5884  
Noga posude koja se račva u tri kraka. Oker boje, slabo zaglađene i neravne površine.  
Dimenzije:  $\varnothing$  dna 7,2 m, vis. 3,35 cm, deblj. stijenke 0,7 cm
7. inv. 20382  
Bikonični lončić izvučena ruba. Tamnosive boje, mat, glatke površine. Djelomično rekonstruiran.  
Dimenzije:  $\varnothing$  ruba 8 cm, vis. 8 cm,  $\varnothing$  dna 5 cm, deblj. stijenke 0,4 cm
8. inv. 5996  
Ulomak zdjele bikonična tijela i izvijena ruba. Oker boje, glatke površine.  
Dimenzije: 8,2 x 6,4 cm, deblj. stijenki 0,7 cm
9. inv. 20832  
Zaobljeni lončić s dvjema ušicama na trbuhu. Sive boje, neravne, slabo zaglađene površine; polovica posude je rekonstruirana.  
Dimenzije:  $\varnothing$  ruba 6 cm, vis. 7,4 cm,  $\varnothing$  dna 4,6 cm, deblj. stijenke 0,5 cm
10. inv. 4935  
Ulomak S-profilirana tijela s ušicom na trbuhu. Oker-sive boje, glatke površine.  
Dimenzije: 6,8 x 5,1 cm, deblj. stijenke 0,65 cm
11. inv. 6190  
Zvonolika noga. Tamnosive boje, uglačane površine.  
Dimenzije:  $\varnothing$  noge 6,8 cm, vis. 4,5 cm, deblj. stijenke 0,8 cm
12. inv. 5886  
Noga s rupom. Tamnosive boje, mat, glatke površine.  
Dimenzije:  $\varnothing$  dna 10,6 cm, vis. 7,4 cm
13. inv. 6328  
Posudica zaobljena tijela s izljev-
- kom. Oker boje, slabo zaglađene i neravne površine.  
Dimenzije: vis. 5,8 cm, deblj. stijenke 0,6 cm  
Lit.: Hoffiller 1938: T. 2:1
14. inv. 6187  
Konična zdjelica. Neravne, slabo zaglađene površine, žučkastosive boje.  
Dimenzije:  $\varnothing$  ruba 3,2 cm, vis. 1,6 cm,  $\varnothing$  dna 1,2 cm, deblj. stijenke 0,2 cm  
Lit.: Hoffiller 1938: T. 2:6; Balen 1982: T.3:9
15. inv. 7910, kv. 18, dub. 5,90  
Kupa zaobljena tijela na punoj nozi. Žučkasto-smeđe boje, slabo zaglađene i neravne površine.  
Dimenzije:  $\varnothing$  ruba 3,5 cm, vis. 3,2 cm,  $\varnothing$  noge 2,3 cm, deblj. stijenke 0,5 cm  
Lit.: Schmidt 1945: sl. 74: 6; Balen 1982 T. 3:6
16. inv. 5741  
Zdjela zaobljena tijela, uvučena ruba i ravna dna. Čitava površina posude ukrašena je ubadanjem i urezivanjem, a na tijelu su posude četiri gredaste plastične aplikacije. Oker-smeđe boje, slabo zaglađene i neravne površine. Djelomično rekonstruirana.  
Dimenzije: vis. 20,8 cm,  $\varnothing$  ruba 30 cm,  $\varnothing$  dna 10,8 cm, deblj. stijenke 0,8 cm  
Lit.: Hoffiller 1938: T. 2:5
17. inv. 5996  
Ulomak zdjele S-profilirana tijela s ušicom na trbuhu. Ukrašena žigosanim ubodima, tamnosive boje, uglačane površine.  
Dimenzije: 10,2 x 10,5 cm, deblj. stijenke 0,6 cm  
Lit.: Hoffiller 1938: T. 9:11; Balen 2002a: T. 4:3
18. inv. 5880  
Ulomak zdjele S-profilacije ukrašene žigosanjem. Tamnosmeđe boje,

## Catalogue

1. inv. 7914, q. A, depth. 5,40  
A pot with a rounded profile and a cylindrical neck, decorated by barbotine, light brown. Five pairs of relief extrusions are placed at the belly and base of the vessel.  
Dimensions: ht. 42,6 cm, rim width 30 cm, base width 13,2 cm, wall width 1,2 cm  
Lit.: Schmidt 1945: fig. 74:1; Minichreiter 1992a: fig. 21:1; Die Neandertaler 1994: 111, cat. No. N 2 (the inventory number and the finding site are incorrect)
2. inv. 16933, q. A-B, depth. 4,80  
An S-profiled pot with four lugs at the belly and a ring-shaped foot. Red, poorly polished and uneven surface.  
Dimensions: rim diameter 7,8 cm, base diameter 6 cm, ht. 9,8 cm, wall width 0,5 cm.  
Lit.: Schmidt 1945: fig. 74:5; Dimitrijević 1969: T.2:2, Dimitrijević 1974: T.IV:10, Minichreiter 1992a: fig.21:9.
3. inv. 20369, q. 14, depth. 4,50  
A rounded little pot with a flat base. Dark grey, uneven, poorly polished surface, partly reconstructed.  
Dimensions: rim diameter 5,5 cm, ht. 8,4 cm, base diameter 4,5 cm, wall width 0,5 cm
4. inv. 4937 (fig. 20)  
A rounded chalice on a foot. The foot bottom consists of 5 tentacles (one is damaged). Yellowish-grey, matte surface.  
Dimensions: rim diameter 5 cm, ht. 5 cm, wall width 0,5 cm, foot diameter 4,5 cm  
Lit.: Hoffiller 1938: T.2:4
5. inv. 7907, q. 19, depth. 4,00  
A conical, shallow chalice on foot. The foot bottom is divided into 10 tentacles. Yellow-brown, poorly polished and uneven surface.  
Dimensions: rim diameter 5,7 cm, ht. 4,2 cm, foot diameter 5 cm, wall width 0,5 cm
6. inv. 5884  
A vessel foot composed of three tentacles. Ochre, poorly polished and uneven surface.  
Dimensions: base diameter 7,2 m, ht. 3,35 cm, wall width 0,7 cm
7. inv. 20382  
A biconical small pot, partly reconstructed. Dark grey, matte surface.  
Dimensions: rim diameter 8 cm, ht. 8 cm, base diameter 5 cm, wall width 0,4 cm
8. inv. 5996  
A fragment of a bowl with a biconical body and an everted neck, ochre, matte surface.  
Dimensions: 8,2 x 6,4 cm, wall width 0,7 cm
9. inv. 20382  
A rounded small pot with two lugs at the belly. Grey, uneven, poorly polished surface, half of the vessel is reconstructed.  
Dimensions: rim diameter 6 cm, ht. 7,4 cm, base diameter 4,6 cm, wall width 0,5 cm
10. inv. 4935  
A fragment of an S-profiled body with a lug at the belly. Ochre – grey, matte surface.  
Dimensions: 6,8 x 5,1 cm, wall width 0,65 cm
11. inv. 6190  
A bell-shaped foot, dark grey, polished surface. Dimensions: foot diameter 6,8 cm, ht. 4,5 cm, wall width 0,8 cm
12. inv. 5886  
A foot with a hole, dark grey, matte surface.  
Dimensions: base diameter 10,6 cm, ht. 7,4 cm
13. inv. 6328  
A small vessel with a rounded body and a poorly polished and uneven surface.  
Dimensions: ht. 5,8 cm, wall width 0,6 cm  
Lit.: Hoffiller 1938: T.2:1
14. inv. 6187  
A conical small bowl, uneven, poorly polished surface, yellowish-grey.  
Dimensions: rim diameter 3,2 cm, ht. 1,6 cm, base diameter 1,2 cm, wall width 0,2 cm  
Lit.: Hoffiller 1938: T.2:6, Balen 1982: T.3:9
15. inv. 7910, q. 18, depth. 5,90  
A rounded chalice on a full foot, yellowish-grey, poorly polished and uneven surface.  
Dimensions: rim diameter 3,5 cm, ht. 3,2 cm, foot diameter 2,3 cm, wall width 0,5 cm  
Lit.: Schmidt 1945: fig. 74: 6, Balen 1982: T.3:6
16. inv. 5741  
A rounded bowl with an indent rim and a flat base. The whole surface is decorated by stabbing and incision and on the vessel's body four relief beam-like decorations are applied. The vessel is ochre – brown, of a poorly polished and uneven surface. Partly reconstructed.  
Dimensions: ht. 20,8 cm, rim diameter 30 cm, base diameter 10,8 cm, wall width 0,8 cm  
Lit.: Hoffiller 1938: T.2:5
17. inv. 5996  
A fragment of a bowl with a lug at the belly, S-profiled, decorated by impressed stabbings. Dark grey, polished surface.  
Dimensions: 10,2 x 10,5 cm, wall width 0,6 cm  
Lit.: Hoffiller 1938: T. 9:11; Balen 2002a: T. 4:3

- uglačane površine.  
Dimenzije: 12,5 x 6,2 cm, deblj. stijenke 0,7 cm  
Lit.: Hoffiller 1938: T. 6:15
- 19.** inv. 7895, kv. 18, dub. 5,50  
Zdjela s tunelastim ručkama na trbuhu i ravnim dnom. Ispod ruba i na ramenu nalazi se ukras izveden ubadanjem. Polovica je posude oker boje, a polovica tamnosmeđe boje; uglačana površina.  
Dimenzije: vis. 18,8 cm, ø ruba 19 cm, ø dna 9,4 cm, deblj. stijenke 0,6 cm
- 20.** inv. br. 4678  
Ulomak lončića sive boje. Površina je slabo zaglađena i neravna, a vidljive su sitne primjese u sastavu gline. Zaobljena tijela i uvučena ruba. Ukrašen urezivanjem – motiv riblje kosti.  
Dimenzije: ø ruba 11 cm, deblj. stijenke 0,9 cm
- 21.** inv. 4522  
Šalica S-profilirana tijela i s trakastom ručkom sedlasta presjeka. Trbuh je ukrašen kaneliranjem. Tamnosive boje, uglačane površine.  
Dimenzije: vis. 6,8 cm, ø ruba 7 cm, ø dna 2 cm, deblj. stijenke 0,3 cm  
Lit.: Hoffiller 1938: T. 3:9
- 22.** inv. 4939  
Dio šalice niska zaobljena trbuha i visoka cilindrična vrata. Tamnosive boje, mat površine.  
Dimenzije: deblj. stijenke 0,3 cm
- 23.** inv. 20383  
Šalica niska zaobljena trbuha i visoka cilindrična vrata te blago izvijena ruba; sive boje, glatke, mat površine. Trakasta ručka je rekonstruirana. Trbuh je ukrašen plitkim kanelurama.  
Dimenzije: vis. 6,8 cm, ø ruba 4,8 cm, ø dna 2,8 cm, deblj. stijenke 0,3 cm
- 24.** inv. 5742  
Šalica niska zaobljena trbuha i visoka cilindrična vrata blago izvijena ruba, s trakastom ručkom koja nadvisuje rub. Ukrašena je kaneliranjem i trima plastičnim rebrima s urezima. Tamnosmeđe boje, uglačane površine.  
Dimenzije: vis. 8,2 cm, ø ruba 4,8 cm, ø dna 3,5 cm, šir. ručke 1,6 cm  
Lit.: Hoffiller 1938: T. 3:1
- 25.** inv. 5743 (sl. 22)  
Šalica niska zaobljena trbuha i duga cilindrična vrata blago izvijena ruba, s trakastom ručkom koja nad-
- visuje rub. Ukrašena je kaneliranjem i trima plastičnim rebrima s urezima. Tamnosmeđe boje, uglačane površine.  
Dimenzije: vis. 9 cm, ø ruba 5 cm, ø dna 3 cm, šir. ručke 1,8 cm, deblj. stijenke 0,25 cm.  
Lit.: Hoffiller 1938: T. 3:3; Dimitrijević 1979b: T. XXIII:9; Marković 1994: T. 28:4
- 26.** inv. 5744  
Šalica niska zaobljena trbuha i visoka cilindrična vrata blago izvijena ruba. Trakasta ručka je rekonstruirana. Ukrašena je kaneliranjem i trima plastičnim rebrima s urezima. Tamnosive boje, mat površine.  
Dimenzije: vis. 8,5 cm, ø ruba 5,4 cm, ø dna 3,5 cm
- 27.** inv. 7936, kv. 9, dub. 2,40 (sl. 23)  
Izdužena, ovalna posuda tamnosive boje, djelomično uglačane površine, kratka cilindrična vrata i bikonična tijela. Vrat je naznačen plastičnim prstenom od kojeg se na dvije strane, prema bikoničnom prijelomu spuštaju tri plastična rebra te na trbuhu završavaju ušicama.  
Dimenzije: vis. 10,5 cm, ø ruba 5,4 cm, ø trbuha 13,7, ø dna 6,1 cm  
Lit.: Dimitrijević 1979b: T. XXII:8; Marković 1994: T. 28:5
- 28.** inv. 4675  
Izdužena, ovalna posuda s tunelastim ušicama na najširem dijelu. Ravna dna i rekonstruirana cilindrična vrata. Tamnosmeđe boje, uglačane površine.  
Dimenzije: vis. 10,6 cm, ø ruba 8,4 cm, ø dna 6,8 cm, ø trbuha s ušicama 24,4 cm  
Lit.: Hoffiller 1938: T. 2:2
- 29.** inv. 7859, kv. 14, dub. 4,60  
Kalotasta zdjela, blago zaobljena dna s dvjema ušicama. Uglačane površine, tamnosmeđe boje. Tijelo posude ukrašeno je žigosanjem i brazdastim urezivanjem.  
Dimenzije: vis. 5,7 cm, ø ruba 20,7 cm, deblj. stijenke 0,4 cm  
Lit.: Dimitrijević 1962: T. III:21; Marković 1994: T. 30:2; Balen 2002a: T.5:1
- 30.** inv. 5879  
Ulomak zdjele zaobljena tijela. Ukras izveden brazdastim urezivanjem i žigosanjem. Mat, glatke površine; izvana je smeđe, a iznutra tamnosmeđe boje.  
Dimenzije: 7 x 7,8 cm, deblj. stijenke 0,65  
Lit.: Hoffiller 1938: T. 9:9
- 31.** inv. 5996  
Ulomak zdjele blago izvijena ruba. Ukrašen žigosanjem. Iznutra je crvene, a izvana smeđe boje; djelomično uglačane površine.  
Dimenzije: 6,2 x 4,7 cm, deblj. stijenke 0,5 cm  
Lit.: Hoffiller 1938: T. 9:12.
- 32.** inv. 5880  
Ulomak zdjele ukrašene brazdastim urezivanjem i žigosanjem. Mat, glatke površine i smeđe boje.  
Dimenzije: 7,1 x 4,5 cm, deblj. stijenke 0,5 cm  
Lit. Hoffiller 1938: T. 9:13
- 33.** inv. 7877, kv. 4, dub. 3,40  
Ulomak zdjele blago izvijena ruba, ukrašene žigosanjem. Tamnosive boje, djelomično uglačane površine.  
Dimenzije: 7,2 x 4,7 cm, deblj. stijenke 0,5 cm
- 34.** inv. 5879  
Ulomak zdjele zaobljena tijela, ukrašene žigosanjem. Sivosmeđe boje, djelomično uglačane površine.  
Dimenzije: 4,5 x 4,4 cm, deblj. stijenke 0,6 cm  
Lit.: Hoffiller 1938: T. 9:18
- 35.** inv. 4936  
Ulomak zdjele zaobljena tijela, ukrašene žigosanjem. Tamnosmeđe boje, djelomično uglačane površine.  
Dimenzije: 4,1 x 5,6 cm, deblj. stijenke 0,5 cm  
Lit.: Hoffiller 1938: T. 9:16
- 36.** inv. 4936  
Ulomak zdjele izvijena ruba, ukrašene brazdastim urezivanjem. Tamnosive boje, djelomično uglačane površine.  
Dimenzije: 5,3 cm x 2,6 cm, deblj. stijenke 0,5 cm
- 37.** inv. 4936  
Ulomak zdjele izvijena ruba, ukrašene brazdastim urezivanjem. Tamnosive boje, djelomično uglačane površine.  
Dimenzije: 7,3 cm x 6,8 cm, deblj. stijenke 0,5 cm
- 38.** inv. 5880  
Ulomak zdjele zaobljena tijela i uvučena ruba. Ispod ruba je ukras izveden brazdastim urezivanjem. Glatke, mat površine, iznutra sive boje, a izvana tamnosive boje.  
Dimenzije: 7 x 7 cm, deblj. stijenke 0,85 cm  
Lit. Hoffiller 1938: T. 9:15

18. inv. 5880  
A fragment of an S-profiled bowl, decorated by impressing, dark yellow, polished surface.  
Dimensions: 12,5 x 6,2 cm, wall width 0,7 cm  
Lit.: Hoffiller 1938: T. 6:15
19. inv. 7895, q. 18, depth. 5,50  
A bowl with tunnel-shaped handles at the belly and a flat bottom. Below the rim, at the larger part of the belly the ornament is performed by stabbing. One half of the vessel is ochre, the other is dark brown, the surface is polished.  
Dimensions: ht. 18,8 cm, rim diameter 19 cm, base diameter 9,4 cm, wall width 0,6 cm
20. inv. No. 4678  
A fragment of a small, grey pot. The surface is poorly polished and uneven. Tiny impurities are visible in the clay. It has a rounded body and an indent rim and is decorated by incision with a »fish bone« motif. Dimensions: rim diameter 11 cm, wall width 0,9 cm
21. inv. 4522  
An S-profiled cup with a band – shaped handle and a saddle-shaped break. The belly is decorated by fluting. Dark grey, polished surface. Dimensions: ht. 6,8 cm, rim diameter 7 cm, base diameter 2 cm, wall width 0,3 cm  
Lit.: Hoffiller 1938: T. 3:9
22. inv. 4939  
A cup fragment with a shallow, rounded rim and a long cylindrical neck. Dark brown, matte surface. Dimensions: wall width 0,3 cm
23. inv. 20383  
A cup with a shallow rounded belly and a long cylindrical neck with a gently everted rim. Grey, polished and matte surface. The banded handle is reconstructed, the belly is decorated with shallow flutes. Dimensions: ht. 6,8 cm, rim diameter 4,8 cm, base diameter 2,8 cm, wall width 0,3 cm
24. inv. 5742  
A cup with a shallow rounded belly, a long cylindrical neck, a gently everted rim and a banded handle that out-tops the rim. Decorated by fluting and three relief applied ribs decorated with commas. Dark brown, polished surface.  
Dimensions: ht. 8,2 cm, rim diameter 4,8 cm, base diameter 3,5 cm, handle width 1,6 cm  
Lit.: Hoffiller 1938: T. 3:1
25. inv. 5743 (fig. 22)  
A cup with a shallow, rounded belly and a long cylindrical neck with a gently everted rim and a banded handle that both out-tops the rim. It is decorated by fluting and with three relief applied ribs embellished with commas. Dark brown, polished surface.  
Dimensions: ht. 9 cm, rim diameter 5 cm, base diameter 3 cm, handle width 1,8 cm, wall width 0,25 cm.  
Lit.: Hoffiller 1938: T. 3:3; Dimitrijević 1979b: T. XXIII:9; Marković 1994: T. 28:4
26. inv. 5744  
A cup with a shallow rounded belly and a long cylindrical neck with a gently everted rim. The banded handle is reconstructed. The cup is decorated by fluting and with three relief applied ribs decorated with commas. Dark grey, matte surface.  
Dimensions: ht. 8,5 cm, rim diameter 5,4 cm, base diameter 3,5 cm
27. inv. 7936, q. 9, depth. 2,40 (fig. 23)  
An elongated, oval vessel, dark grey, partly polished surface, with a short cylindrical neck and a biconical body. The neck has a relief applied ring along to which on two sides, following the biconical break, three relief applied ribs descend and end with the lugs at the belly section.  
Dimensions: ht. 10,5 cm, rim diameter 5,4 cm, belly diameter 13,7, base diameter 6,1 cm  
Lit.: Dimitrijević 1979b: T. XXII:8; Marković 1994: T. 28:5
28. inv. 4675  
An elongated, oval vessel with tunnel-shaped lugs at the widest section. It has a flat bottom and a reconstructed cylindrical neck. Dark Brown, polished surface.  
Dimensions: ht. 10,6 cm, rim diameter 8,4 cm, base diameter 6,8 cm, belly diameter with lugs 24,4 cm  
Lit.: Hoffiller 1938: T.2:2
29. inv. 7859, q. 14, depth. 4,60  
A calotte-shaped bowl with a gently rounded base and two lugs. Polished surface, dark Brown. The vessel's body is decorated by impressing and grooved incision.  
Dimensions: ht. 5,7 cm, rim diameter 20,7 cm, wall width 0,4 cm  
Lit.: Dimitrijević 1962: T. III:21; Marković 1994: T. 30:2; Balen 2002a: T. 5:1
30. inv. 5879  
A fragment of a bowl with a rounded rim and bottom, decorated with grooved incision and impressing. Matte surface, exterior brown, interior dark brown.  
Dimensions: 7 x 7,8 cm, wall width 0,65  
Lit.: Hoffiller 1938: T. 9:9.
31. inv. 5996  
A fragment of a bowl with a gently everted rim, decorated by impressing. Interior red, exterior brown, partly polished surface. Dimensions: 6,2 x 4,7 cm, wall width 0,5 cm  
Lit.: Hoffiller 1938: T. 9:12.
32. inv. 5880  
A fragment of a bowl decorated by grooved incision and impressing. Matte surface, brown.  
Dimensions: 7,1 x 4,5 cm, wall width 0,5 cm  
Lit. Hoffiller 1938: T. 9:13
33. inv. 7877, q. 4, depth. 3,40  
A fragment of a bowl with a gently everted rim, decorated by impressing. Dark grey, partly polished surface.  
Dimensions: 7,2 x 4,7 cm, wall width 0,5 cm
34. inv. 5879  
A fragment of a rounded bowl decorated by impressing. Dark brown, partly polished surface.  
Dimensions: 4,5 x 4,4 cm, wall width 0,6 cm  
Lit.: Hoffiller 1938: T. 9:18
35. inv. 4936  
A fragment of a bowl with a rounded body decorated by impressing. Dark brown, partly polished surface.  
Dimensions: 4,1 x 5,6 cm, wall width 0,5 cm  
Lit.: Hoffiller 1938: T. 9:16
36. inv. 4936  
A fragment of a bowl with an everted rim decorated by grooved incision. Dark grey, partly polished surface.  
Dimensions: 5,3 cm x 2,6 cm, wall width 0,5 cm
37. inv. 4936  
A fragment of a bowl with an everted rim, decorated with grooved incision. Dark grey, partly polished surface.  
Dimensions: 7,3 cm x 6,8 cm, wall width 0,5 cm
38. inv. 5880  
A fragment of a bowl with a rounded body and an indent rim.

- 39.** inv. 5806 (sl. 25)  
Zdjela izvučena vrata, naglašena trbuha i omphalos dna. Ukrašen je pod rubom od dva reda uboda, a na trbuhu i na prijelazu iz vrata u trbuh izveden je brazdastim urezivanjem. Tamnosmeđe boje, uglačane površine.  
Dimenzije: vis. 8,6 cm,  $\varnothing$  ruba 12,6 cm, deblj. stijenke 0,4 cm  
Lit.: Hoffiller 1938: T. 4:6
- 40.** inv. 7903, kv. A, dub. 3,60  
Zdjela izvučena, cilindrična vrata, ravna dna i s četirima ušicama na trbuhu. Ukrašen je izveden žigosanjem. Tamnosmeđe boje, uglačane površine.  
Dimenzije: vis. 6,8 cm,  $\varnothing$  ruba 15,4 cm,  $\varnothing$  dna 6,6 cm, deblj. stijenke 0,4 cm  
Lit.: Balen 2002a: T. 5:2
- 41.** inv. 7935, kv. 24, dub. 5,70  
Zdjela cilindrična vrata, bez izražena dna i s dvjema plastičnim aplikacijama na trbuhu. Tamnosmeđe boje, uglačane površine.  
Dimenzije: vis. 6,6 cm,  $\varnothing$  ruba 13,4 cm, deblj. stijenke 0,4 cm
- 42.** inv. 20370, kv. B, dub. 3,20  
Dublja zdjela ravna dna, blago naglašena trbuha i konična vrata, s plastičnim uparenim aplikacijama na trbuhu. Rekonstruirana je polovica posude. Smeđe boje, djelomično uglačane površine.  
Dimenzije: vis. 7,6 cm,  $\varnothing$  ruba 20 cm,  $\varnothing$  dna 8 cm, deblj. stijenke 0,4 cm
- 43.** inv. 4519  
Ulomak zdjele S-profilacije. Ukrašen brazdastim urezivanjem. Tamnosmeđe boje, mat, glatke površine.  
Dimenzije: 8,8 x 8,4 cm, deblj. stijenke 0,8 cm  
Lit.: Hoffiller 1938: T. 5:2
- 44.** inv. 4518  
Ulomak široke trakaste ručke. Oker do tamnosmeđe boje, djelomično uglačane površine.  
Dimenzije: 6,6 x 6 cm, deblj. stijenke 1,2 cm
- 45.** inv. 20371  
Šalica bikonična tijela bez izražena dna. Tamnosmeđe boje, djelomično uglačane površine.  
Dimenzije: vis. 5,3 cm,  $\varnothing$  ruba 5,9 cm, deblj. stijenke 0,15 cm
- 46.** inv. 5017  
Posuda konična tijela i ravna dna, blago izvijena ruba. Dno je djelomično rekonstruirano. Crvenkastosmeđe boje, djelomično uglačane površine.  
Dimenzije: vis. 5,8 cm,  $\varnothing$  ruba 6,6 cm,  $\varnothing$  dna 3,4 cm, deblj. stijenke 0,3 cm  
Lit.: Hoffiller 1938: T. 1:6
- 47.** inv. 4934  
Ulomak zaobljena lonca. Mat, glatke površine, oker boje.  
Dimenzije: 8,5 x 12, deblj. stijenke 1 cm
- 48.** inv. 4934  
Ulomak zaobljena lonca. Mat, glatke površine. Unutarnja strana je tamnosmeđe, a vanjska oker boje.  
Dimenzije: 6,4 x 10,2, deblj. stijenke 0,9 cm
- 49.** inv. 5683  
Lončić zaobljena tijela s dvjema plastičnim, bradavičastim aplikacijama. Smeđe boje, glatke, mat površine.  
Dimenzije: vis. 7,8 cm,  $\varnothing$  ruba 6 cm,  $\varnothing$  dna 4,5 cm  
Lit.: Hoffiller 1938: T. 1:8.
- 50.** inv. 7868, kv. 18, dub. 3,90  
Ulomak lonca zaobljena tijela s plastičnom, čepastom drškom pod rubom. Ukrašen je izveden rovašenjem ispunjenim inkrustacijom. Djelomično rekonstruirano, crvene boje, uglačane površine.  
Dimenzije: deblj. stijenke 0,6 cm  
Lit.: Orion 2000: kat. br. 42.
- 51.** inv. 5876  
Ulomak lonca zaobljena tijela s vertikalnim plastičnim rebrom, ukrašenim otiskivanjem. Ukrašen na posudi izveden je rovašenjem ispunjenim inkrustacijom. Tamnosive boje, djelomično uglačane površine.  
Dimenzije: 9,5 x 6,2 cm, deblj. stijenke 1 cm  
Lit.: Hoffiller 1938: T. 4:7.
- 52.** inv. 5880  
Ulomak lonca zaobljena tijela. Tamnosive boje, slabo zaglađene i neravne površine. Ukrašen na posudi izveden je rovašenjem ispunjenim inkrustacijom.  
Dimenzije: 7,1 x 7,6 cm, deblj. stijenke 1,2 cm
- 53.** inv. 5880  
Ulomak posude zaobljena tijela, ukrašen rovašenjem ispunjenim inkrustacijom. Tamnosive boje, glatke, mat površine.  
Dimenzije: 9,9 x 5,1 cm, deblj. stijenke 0,6 cm  
Lit.: Hoffiller 1938: T. 8:8.
- 54.** inv. 5882  
Ulomak zaobljena tijela s čepastom drškom. Ukrašen je izveden rovašenjem ispunjenim inkrustacijom. Tamnosive boje, uglačane površine.  
Dimenzije: 5,4 x 5,5 cm, deblj. stijenke 0,7 cm  
Lit.: Hoffiller 1938: T. 6:3.
- 55.** inv. 4936  
Ulomak posude zaobljena tijela ukrašena rovašenjem. Unutarnja strana je oker boje, a vanjska smeđe; glatke, mat površine.  
Dimenzije: 9,6 x 5 cm, deblj. stijenke 1 cm  
Lit.: Hoffiller 1938: T. 8:1.
- 56.** inv. 7867, kv. 17–22, dub. 2,00–1,90  
Ulomak posude zaobljena tijela, ukrašena rovašenjem. Oker boje, tamnosivog presjeka, glatke, mat površine.  
Dimenzije: 32 x 13 cm, deblj. stijenke 0,8 cm
- 57.** inv. 4931  
Ulomak lonca zaobljena tijela i ravna ruba, ukrašena urezima. Tamnosive boje, slabo zaglađene i neravne površine.  
Dimenzije: 3,6 x 5,4 cm, deblj. stijenke 1 cm
- 58.** inv. 4931  
Ulomak lonca zaobljena tijela s plastičnom trakom pod rubom. Tamnosmeđe boje, slabo zaglađene i neravne površine.  
Dimenzije: 6,6 x 5,7 cm, deblj. stijenke 1,2 cm
- 59.** inv. 4931  
Ulomak lonca zaobljena tijela, blago izvučena ruba. Rub je ukrašen otiskom prsta. Unutarnja površina je oker, a vanjska smeđe boje; slabo zaglađene i neravne površine.  
Dimenzije:  $\varnothing$  lonca 24 cm, deblj. stijenke 0,8 cm
- 60.** inv. 4931  
Ulomak lonca zaobljena tijela i blago izvučena ruba, ukrašena plastičnom trakom s otiscima. Oker-smeđe boje, glatke površine.  
Dimenzije: 8,5 x 7,6 cm, deblj. stijenke 1,1 cm  
Lit.: Hoffiller 1938: T.9:3
- 61.** inv. 4934  
Ulomak lonca zaobljena tijela i blago izvijena ruba. Svjetlosmeđe boje, glatke površine.  
Dimenzije: 7,7 x 8,7 cm, deblj. stijenke 1 cm

- A decoration with grooved incision is placed below the rim. Matte surface, grey interior and dark grey exterior.  
Dimensions: 7 x 7 cm, wall width 0,85 cm  
Lit. Hoffiller 1938: T. 9:15
- 39.** inv. 5806 (fig. 25)  
A bowl with an elongated neck, accentuated belly and omphalos base. The decoration below the rim is made in the form of two lines of stabblings whereas at the belly and at the transition from the neck to the belly the decoration is made by grooved incision. Dark brown, polished surface.  
Dimensions: ht. 8,6 cm, rim diameter 12,6 cm, wall width 0,4 cm  
Lit.: Hoffiller 1938: T. 4:6
- 40.** inv. 7903, q. A, depth. 3,60  
A bowl with an extended, cylindrical neck, flat base and four lugs at the belly. The decoration is made by impressing. Dark brown, polished surface.  
Dimensions: ht. 6,8 cm, rim diameter 15,4 cm, base diameter 6,6 cm, wall width 0,4 cm  
Lit.: Balen 2002a: T. 5:2
- 41.** inv. 7935, q. 24, depth. 5,70  
A bowl with a cylindrical neck without an accentuated base and two relief applied decorations at the belly. Dark brown, polished surface.  
Dimensions: ht. 6,6 cm, rim diameter 13,4 cm, wall thickness 0,4 cm
- 42.** inv. 20370, q. B, depth. 3,20  
A deep, flat-based bowl with a gently accentuated belly and a conical neck with relief applied decorations on the belly grouped in two. Half of the vessel is reconstructed. Brown, partly polished surface.  
Dimensions: ht. 7,6 cm, rim diameter 20 cm, base diameter 8 cm, wall width 0,4 cm
- 43.** inv. 4519  
A fragment of an S-profiled bowl, decorated by grooved incisions, dark brown, matte, polished surface.  
Dimensions: 8,8 x 8,4 cm, wall width 0,8 cm  
Lit.: Hoffiller 1938: T. 5:2
- 44.** inv. 4518  
A fragment of a broad banded handle, ochre-dark brown, partly polished surface.  
Dimensions: 6,6 x 6 cm, wall width 1,2 cm
- 45.** inv. 20371  
A cup with a biconical profile without an accentuated base. Dark brown, partly polished surface.  
Dimensions: ht. 5,3 cm, rim diameter 5,9 cm, wall width 0,15 cm
- 46.** inv. 5017  
A conical vessel with a flat base and a gently everted rim. The base is partly reconstructed. Reddish-brown, partly polished surface.  
Dimensions: ht. 5,8 cm, rim diameter 6,6 cm, base diameter 3,4 cm, wall width 0,3 cm  
Lit.: Hoffiller 1938: T. 1:6
- 47.** inv. 4934  
A fragment of a rounded pot, matte surface, ochre.  
Dimensions: 8,5 x 12, wall width 1 cm
- 48.** inv. 4934  
A fragment of a rounded pot, matte surface. Interior dark brown, exterior ochre.  
Dimensions: 6,4 x 10,2, wall width 0,9 cm
- 49.** inv. 5683  
A small rounded pot with two relief applied, nipple-shaped decorations. Brown, matte surface.  
Dimensions: ht. 7,8 cm, rim diameter 6 cm, base diameter 4,5 cm  
Lit.: Hoffiller 1938: T. 1:8.
- 50.** inv. 7868, q. 18, depth. 3,90  
A fragment of a rounded pot with a relief applied stopper-like handle. The decoration is made by notching filled with encrustation. Partly reconstructed, red, polished surface.  
Dimensions: wall width 0,6 cm  
Lit.: Orion 2000: cat. No. 42.
- 51.** inv. 5876  
A fragment of a rounded pot with a vertical relief applied rib decorated by printing. The decoration on the vessel is made by notching filled with encrustation. Dark grey, partly polished surface.  
Dimensions: 9,5 x 6,2 cm, wall width 1 cm  
Lit.: Hoffiller 1938: T. 4:7.
- 52.** inv. 5880  
A fragment of a rounded pot, dark grey, poorly polished and uneven surface. The decoration is made by notching filled with encrustation.  
Dimensions: 7,1 x 7,6 cm, wall width 1,2 cm
- 53.** inv. 5880  
A fragment of a vessel decorated by notching filled with encrustation. Dark grey, matte surface.  
Dimensions: 9,9 x 5,1 cm, wall width 0,6 cm  
Lit.: Hoffiller 1938: T. 8:8.
- 54.** inv. 5882  
A fragment of a rounded body with a stopper—like handle. The decoration is made by notching filled with encrustation. Dark grey, polished surface.  
Dimensions: 5,4 x 5,5 cm, wall width 0,7 cm  
Lit.: Hoffiller 1938: T. 6:3.
- 55.** inv. 4936  
A fragment of a rounded vessel decorated by notching. Interior ochre, exterior brown, matte surface.  
Dimensions: 9,6 x 5 cm, wall width 1 cm  
Lit.: Hoffiller 1938: T. 8:1.
- 56.** inv. 7867, q. 17-22, depth. 2,00–1,90  
A fragment of a rounded vessel decorated by notching. Ochre, with a dark grey break and matte surface.  
Dimensions: 32 x 13 cm, wall width 0,8 cm
- 57.** inv. 4931  
A fragment of a rounded pot and flat rim decorated by incisions. Dark grey, poorly polished and uneven surface.  
Dimensions: 3,6 x 5,4 cm, wall width 1 cm
- 58.** inv. 4931  
A fragment of a rounded pot with a relief applied band below the rim. Dark brown, poorly polished and uneven surface.  
Dimensions: 6,6 x 5,7 cm, wall width 1,2 cm
- 59.** inv. 4931  
A fragment of a rounded pot, with a gently extended rim. The rim is decorated with fingerprints. Interior ochre, exterior brown, poorly polished and uneven surface.  
Dimensions: pot diameter 24 cm, wall thickness 0,8 cm
- 60.** inv. 4931  
A fragment of a rounded pot with a gently extended rim, decorated with relief applied band with imprints. Ochre-brown, matte surface.  
Dimensions: 8,5 x 7,6 cm, wall width 1,1 cm  
Lit.: Hoffiller 1938: T.9:3
- 61.** inv. 4934  
A fragment of a rounded pot with



- 62. inv. 4678**  
 Ulomak lonca zaobljena tijela i ravna ruba. Tamnosive boje, glatke površine.  
 Dimenzije: 12,9 x 12,5 cm, deblj. stijenke 1,3 cm
- 63. inv. 4517**  
 Ulomak lonca zaobljena tijela i ravna ruba. Rub je ukrašen otiskom štapića. Unutarnja je površina oker, a vanjska smeđe boje; slabo zaglađene i neravne površine.  
 Dimenzije: 7,4 x 7,5 cm; deblj. stijenke 0,8 cm
- 64. inv. 7845, kv. 13, dub. 4,60 (sl. 26)**  
 Lonac zaobljena tijela, s prstenastim rubom. Na vratu su plastične, bradavičaste aplikacije, a tijelo je bogato ukrašeno rovašenjem ispunjenim inkrustacijom. Tamnosmeđe boje, uglačane površine.  
 Dimenzije: vis. 17,1 cm,  $\emptyset$  ruba 13,6 cm,  $\emptyset$  dna 10 cm, deblj. stijenke 0,6 cm  
 Lit.: Dimitrijević 1977-78: T. 8:7; Dimitrijević 1979c: T. XXXI:4; Marković 1994: T. 33:2; Die Neandertaler 1994: 121, kat. br. V 10; Tasić 1995: T. XXIX:2; Orion 2000: kat. br. 50.
- 65. inv. 7869, kv. 17, dub. 3,10**  
 Ulomak trbuha zaobljena lonca. Ukrašen je brazdastim urezivanjem ispunjenim inkrustacijom. Tamnosive boje, uglačane površine.  
 Dimenzije: 18 x 12 cm, deblj. stijenke 0,6 cm
- 66. inv. 4931**  
 Ulomak lonca S-profilirana tijela, s plastičnim rebrom na vratu. Vanjska površina je oker, a unutarnja sive boje; slabo zaglađene i neravne površine.  
 Dimenzije:  $\emptyset$  lonca 26 cm, deblj. stijenke 1,1 cm  
 Lit.: Hoffiller 1938: T. 9:1
- 67. inv. 4931**  
 Ulomak lonca S-profilirana tijela, s plastičnim rebrom na vratu. Vanjska površina je oker, a unutarnja sive boje, slabo zaglađene i neravne površine.  
 Dimenzije:  $\emptyset$  lonca 16 cm, deblj. stijenke 1,1 cm
- 68. inv. 4931**  
 Ulomak lonca S-profilirana tijela, s otiskom nokta pod rubom. Tamnosmeđe boje, slabo zaglađene i neravne površine.  
 Dimenzije:  $\emptyset$  lonca 12 cm, deblj. stijenke 0,8 cm
- 69. inv. 4678**  
 Ulomak lonca S-profilirana tijela, s plastičnom trakom pod rubom i na ramenu ukrašenu utiskivanjem. Oker boje, glatke, površine.  
 Dimenzije:  $\emptyset$  lonca 19 cm, deblj. stijenke 0,9 cm
- 70. inv. 5867**  
 Ulomak lonca S-profilirana tijela, s plastičnom trakom pod rubom i na ramenu, ukrašene utiskivanjem. Oker boje, glatke, površine.  
 Dimenzije: 18 x 13,8 cm, deblj. stijenke 1,2 cm  
 Lit.: Hoffiller 1938: T.9:4
- 71. inv. 5867**  
 Ulomak lonca S-profilirana tijela. Tamnosive boje. Ispod ruba je plastična traka s otiscima prsta, a tijelo je premazano tankim barbotinom. Vratna zona je uglačana.  
 Dimenzije:  $\emptyset$  lonca 20 cm, deblj. stijenke 0,9 cm  
 Lit.: Hoffiller 1938: T. 2:11.
- 72. inv. 4931**  
 Ulomak lonca S-profilirana tijela. Tamnosive boje. Ispod ruba je ukras izveden štapićem, a tijelo je premazano tankim barbotinom. Na prijelazu iz vrata u tijelo lonca nalazi se ukras izveden otiskom nokta i plastična aplikacija. Vratna zona je uglačana.  
 Dimenzije:  $\emptyset$  lonca 36 cm, deblj. stijenke 1,1 cm  
 Lit.: Hoffiller 1938: T. 9:2.
- 73. inv. 1506**  
 Lončić S-profilirana tijela slabo zaglađene i neravne površine. Ispod ruba i vrata nalazi se ukras izveden utiskivanjem, a tijelo je ukrašeno urezanim, okomitim linijama. Na jednoj strani trbuha nalaze se dvije plastične, bradavičaste aplikacije, a na drugoj jedna. Vanjska strana je tamnosive, a unutrašnja oker boje.  
 Dimenzije: vis. 6,5 cm, r. ruba 6,4 cm,  $\emptyset$  dna 4,2 cm  
 Lit.: Hoffiller 1938: T. 1:1
- 74. inv. 20372, kv. 23, dub. 3,60**  
 Lončić S-profilirana tijela s dvjema ušicama na ramenu posude. Vratni je segment uglačan, a donji dio premazan barbotinom. Ukras pod rubom i na vratu izveden je otiskom nokta. Unutarnja površina je tamnosive, a vanjska svijetlosmeđe boje.  
 Dimenzije: vis. 12 cm,  $\emptyset$  ruba 9,6 cm,  $\emptyset$  dna 6,4 cm, deblj. stijenke 0,6 cm
- 75. inv. 7904, kv. 18-19, dub. 4,00**  
 Lonac S-profilirana tijela s trakastom ručkom na truhu. Ukrašen je žigosanim ubodima. Svijetlosive boje, glatke površine. Polovica posude je rekonstruirana.  
 Dimenzije: vis. 17 cm,  $\emptyset$  ruba 15 cm,  $\emptyset$  dna 9,4 cm, deblj. stijenke 0,6 cm
- 76. inv. 7901, kv. 13, dub. 3,40**  
 Lonac S-profilirana tijela s trakastom ručkom, ušicom i dvjema bradavičastim aplikacijama. Tijelo je ukrašeno okomitim urezanim linijama, a rub otiskom nokta. Žuto-smeđe boje; vratni segment je djelomično uglačan, a tijelo je neravno i slabo zaglađeno.  
 Dimenzije: vis. 11,4 cm,  $\emptyset$  ruba 9,4 cm,  $\emptyset$  dna 6,5 cm, deblj. stijenke 0,5 cm  
 Lit.: Dimitrijević 1979c: T. XXVIII:4.
- 77. inv. 5867**  
 Ulomak lonca S-profilirana tijela. Ukras noktom nalazi se pod rubom i na ramenu posude. Vratni segment je uglačan, a tijelo je slabo zaglađeno i neravno te ukrašeno urezanim snopom linija. Tamnosive boje, s mjestimičnim oker mrljama.  
 Dimenzije:  $\emptyset$  lonca 12 cm, deblj. stijenke 0,6 cm
- 78. inv. 4678**  
 Ulomak lonca S-profilirana tijela s trakastom ručkom na truhu. Slabo zaglađene i neravne površine, tamnosive boje.  
 Dimenzije: 19 x 18 cm, deblj. stijenke 1,3 cm
- 79. inv. 5866**  
 Lonac S-profiliranog tijela. Ukras noktom nalazi se na rubu posude. Vratni segment je djelomično uglačan, a tijelo je premazano barbotinom. Dvije tunelaste ušice smještene su na ramenu posude. Rub je djelomično rekonstruiran. Svijetlosmeđe-sive boje.  
 Dimenzije: vis. 18,2 cm,  $\emptyset$  ruba 16,8 cm,  $\emptyset$  dna 9 cm, deblj. stijenke 0,6 cm  
 Lit.: Hoffiller 1938: T.1:2.
- 80. inv. 20373**  
 Lonac S-profilirana tijela. Nedostaju mu rub i dio vrata. Vratni segment je glatke, mat površine, a tijelo je premazano barbotinom. Na ramenu posude nalazi se ukras izveden noktom te tunelasta ušica s jedne, a tunelasta ručka s druge strane. Svijetlosive boje.  
 Dimenzije: vis. 20 cm,  $\emptyset$  ruba 15,4 cm,  $\emptyset$  dna 9,2 cm, deblj. stijenke 0,6 cm

- a gently everted rim. Light brown, matte surface.  
Dimensions: 7,7 x 8,7 cm, wall width 1 cm.
62. inv. 4678  
A fragment of a rounded pot with a flat base. Dark grey, matte surface. Dimensions: 12,9 x 12,5 cm, wall width 1,3 cm
63. inv. 4517  
A fragment of a rounded pot with a flat base. The rim is decorated with stick prints. Interior ochre, exterior brown, poorly polished and uneven surface.  
Dimensions: 7,4 x 7,5 cm; wall width 0,8 cm
64. inv. 7845, q. 13, depth. 4,60 (fig. 26)  
A pot with a ring-shaped rim. At the neck relief applied nipple-like decorations are placed and the body is decorated by notching filled with encrustation. Dark brown, polished surface.  
Dimensions: ht. 17,1 cm, rim diameter 13,6 cm, base diameter 10 cm, wall width 0,6 cm  
Lit.: Dimitrijević 1977–78: T. 8:7; Dimitrijević 1979c: T. XXXI:4; Marković 1994: T. 33:2; Die Neandertaler 1994: 121, cat. No. V 10; Tasić 1995: T. XXIX:2; Orion 2000: cat. No. 50.
65. inv. 7869, q. 17, depth. 3,10  
A belly fragment of a rounded pot. Decorated by grooved incision filled with encrustation. Dark grey, polished surface.  
Dimensions: 18 x 12 cm, wall width 0,6 cm
66. inv. 4931  
A fragment of an S-profiled pot with a relief applied rib at the neck. The exterior is ochre and the interior grey, poorly polished and uneven surface.  
Dimensions: pot diameter 26 cm, wall width 1,1 cm  
Lit.: Hoffiller 1938: T. 9:1
67. inv. 4931  
A fragment of an S-profiled pot with a relief applied rib at the neck and nail prints at the vessel rim. The exterior is ochre, the interior grey, poorly polished and uneven surface.  
Dimensions: pot diameter 16 cm, wall width 1,1 cm
68. inv. 4931  
A fragment of an S-profiled pot with nail prints below the rim. Dark brown, poorly polished and uneven surface.  
Dimensions: pot diameter 12 cm, wall width 0,8 cm
69. inv. 4678  
A fragment of an S-profiled pot with a relief applied band below the rim and decorated by imprinting at the shoulder. Ochre, matte surface.  
Dimensions: pot diameter 19 cm, wall width 0,9 cm
70. A fragment of an S-profiled pot with a relief applied band below the rim and decorated by imprinting at the shoulder. Ochre, matte surface.  
Dimensions: 18 x 13,8 cm, wall width 1,2 cm  
Lit.: Hoffiller 1938: T. 9:4
71. inv. 5867  
A fragment of an S-profiled pot, dark grey. A relief band with fingerprints is applied below the rim and the body is waxed with a tiny layer of barbotine. The neck section is polished.  
Dimensions: pot diameter 20 cm, wall width 0,9 cm  
Lit.: Hoffiller 1938: T. 2:11.
72. inv. 4931  
A fragment of an S-profiled pot, dark grey. Below the rim a decoration is made with a stick, the body is waxed with a light layer of barbotine. At the transition from the neck to the pot's body a decoration is made by nail prints and a relief application is placed. The neck section is polished.  
Dimensions: pot diameter 36 cm, wall width 1,1 cm  
Lit.: Hoffiller 1938: T. 9:2.
73. inv. 1506  
A small S-profiled pot with a poorly polished and uneven surface. Below the rim and neck the decoration is made by imprinting whereas the body is decorated with incised vertical lines. On one side two and on the other one relief nipple-like decoration is applied. The exterior is dark grey, the interior ochre.  
Dimensions: ht. 6,5 cm, rim diameter 6,4 cm, base diameter 4,2 cm  
Lit.: Hoffiller 1938: T. 1:1
74. inv. 20372, q. 23, depth. 3,60  
A small S-profiled pot with two lugs at the vessel's shoulder. The neck section is polished and the lower part is waxed with barbotine. The decoration below the rim and at the neck is made by nail prints. The interior is dark grey, the exterior light brown.  
Dimensions: ht. 12 cm, rim diameter 9,6 cm, base diameter 6,4 cm, wall width 0,6 cm
75. inv. 7904, q. 18–19, depth. 4,00  
An S-profiled pot with a banded handle at the belly. Decorated with impressed stabblings. Light grey, matte surface. Half of the vessel is reconstructed.  
Dimensions: ht. 17 cm, rim diameter 15 cm, base diameter 9,4 cm, wall width 0,6 cm
76. inv. 7901, q. 13, depth. 3,40  
An S-profiled pot with a banded handle, a lug and two relief applied nipple-like decorations. The body is decorated with vertically incised lines, the rim with nail prints. Yellow-brown, the neck section is partly polished, the body is uneven and poorly polished.  
Dimensions: ht. 11,4 cm, rim diameter 9,4 cm, base diameter 6,5 cm, wall width 0,5 cm  
Lit.: Dimitrijević 1979c: T. XXVIII:4.
77. inv. 5867  
A fragment of an S-profiled pot. Decorated below the rim and at the shoulder with nail prints. The neck section is polished, the body is uneven, poorly polished and decorated with incised groups of lines. Dark grey with sporadic ochre stains.  
Dimensions: pot diameter 12 cm, wall width 0,6 cm
78. inv. 4678  
A fragment of an S-profiled pot with a banded handle. The surface is poorly polished and uneven, dark grey.  
Dimensions: 19 x 18 cm, wall width 1,3 cm
79. inv. 5866  
An S-profiled pot. A nail decoration is placed at the rim of the vessel. The neck section is partly polished and the body is waxed with barbotine. Two tunnel-shaped lugs are placed at the vessel's shoulder. The rim is partly reconstructed. Light brown-grey.  
Dimensions: ht. 18,2 cm, rim diameter 16,8 cm, base diameter 9 cm, wall width 0,6 cm  
Lit.: Hoffiller 1938: T. 1:2.
80. inv. 20373  
An S-profiled pot, the rim and part of the neck are missing. The neck section is matte and the body is waxed with barbotine. At the ves-

- 81.** inv. 7846, kv. 13, dub. 4,40  
Lonac S-profilirana tijela i prstena-  
sta dna. Oker-smeđe boje, uglačane  
površine. Ukrašen rovašenjem i  
ubadanjem ispunjenim bijelom  
inkrustacijom.  
Dimenzije: vis. 20,6,  $\emptyset$  ruba 13,8,  $\emptyset$   
dna 9,3, deblj. stijenke 0,4 cm  
Lit.: Dimitrijević 1956: T. VIII:45;  
Dimitrijević 1977-78: sl. 2:9, T.  
8:6; Dimitrijević 1979c: T. XXX:3;  
Marković 1994: T. 34:4; Die  
Neandertaler 1994: 121, kat. br.  
V 9; Tasić 1995: T. XXX:4; Orion  
2000: kat. br. 28.
- 82.** inv. 5875  
Ulomak lonca S-profilirana tijela.  
Oker boje, djelomično uglačane  
površine. Ukrašen je izveden brazda-  
stim urezivanjem i rovašenjem ispu-  
njenim inkrustacijom.  
Dimenzije:  $\emptyset$  lonca 12 cm, deblj.  
stijenke 0,6 cm  
Lit.: Hoffiller 1938: T. 6:4
- 83.** inv. 4931  
Ulomak zaobljene, duboke zdjele.  
Tamnosmeđe boje, glatke, mat  
površine.  
Dimenzije:  $\emptyset$  ruba 32 cm, deblj. sti-  
jenke 0,8 cm
- 84.** inv. 4931  
Ulomak zaobljene, duboke zdjele.  
Crvenkastosmeđe boje, djelomično  
uglačane površine.  
Dimenzije:  $\emptyset$  ruba 30 cm, deblj. sti-  
jenke 0,5 cm
- 85.** inv. 4834  
Ulomak zaobljene, duboke zdjele.  
Tamnosmeđe boje, glatke površine.  
Dimenzije: 10,8 x 6,5 cm, deblj.  
stijenke 1 cm
- 86.** inv. 4834  
Ulomak zaobljene, duboke zdjele.  
Tamnosive boje, glatke površine.  
Dimenzije: 11,6 x 7,7 cm, deblj.  
stijenke 1 cm
- 87.** inv. 4834  
Ulomak zaobljene, duboke zdjele.  
Tamnosive boje, glatke površine.  
Dimenzije: 13,3 x 8,2 cm, deblj.  
stijenke 1,1 cm
- 88.** inv. 4931  
Ulomak zaobljene, duboke zdjele.  
Tamnosmeđe boje, glatke površine.  
Rub je ukrašen urezivanjem.  
Dimenzije:  $\emptyset$  ruba 27,8 cm, deblj.  
stijenke 1 cm
- 89.** inv. 4931  
Ulomak zaobljene, duboke zdjele.  
Tamnosmeđe boje, glatke površine.  
Dimenzije:  $\emptyset$  ruba 34 cm, deblj. sti-  
jenke 1 cm
- 90.** inv. 7860, kv. 14, dub. 3,10  
Plitka zdjela, blago uvučena vrata  
i zaobljena dna. Tijelo zdjele  
ukrašeno je brazdastim urezivanjem  
ispunjenim inkrustacijom. Dno je  
podijeljeno u četiri polja. Tamnosive  
boje, uglačane površine.  
Dimenzije:  $\emptyset$  ruba 20,6 cm, vis. 6  
cm, deblj. stijenke 0,5 cm  
Lit.: Dimitrijević 1977-78: T. 8:4;  
Dimitrijević 1979c: T. XXX:5;  
Katalog AMZ 1993: kat. br. 13a;  
Marković 1994: T. 34:7; Die  
Neandertaler 1994: 121, kat. br. V  
4; Orion 2000: kat. br. 4.  
Napomena: crtež je nacrtan u  
negativu, a inkrustacija je označena  
crno.
- 91.** inv. 5874  
Ulomak plitke zdjele zaoblje-  
na dna i blago izvučena ruba.  
Donji segment posude ukrašen  
je rovašenjem. Vanjska je stijenka  
smeđe, a unutrašnja tamnosive  
boje; uglačane površine.  
Dimenzije:  $\emptyset$  ruba 15 cm, vis. 4 cm,  
deblj. stijenke 0,4 cm  
Lit.: Hoffiller 1938: T. 5:6, T. 7:15  
(napomena: objavljena su dva  
ulomka iste zdjele)
- 92.** inv. 5880  
Ulomak plitke zdjele zaobljena  
dna i blago izvučena ruba. Rame  
posude ukrašeno je uskom trakom.  
Oker-sive boje, glatke površine.  
Dimenzije:  $\emptyset$  ruba 20 cm, vis. 5,4  
cm, deblj. stijenke 0,6 cm  
Lit.: Hoffiller 1938: T. 8:9.
- 93.** inv. 7861, kv. 19, dub. 4,10 (sl. 28)  
Plitka zdjela, blago uvučena vrata  
i omphalos dna. Tijelo zdjele  
ukrašeno je brazdastim ureziva-  
njem, ispunjenim inkrustacijom.  
Dno je podijeljeno u četiri polja.  
Tamnosive boje, uglačane površine.  
Dimenzije:  $\emptyset$  ruba 16,8 cm, vis. 4,8  
cm, deblj. stijenke 0,4 cm  
Lit.: Katalog AMZ, 1993: kat. br.  
13b; Die Neandertaler 1994: 121,  
kat. br. V 5; Orion 2000: kat. br. 3.  
Napomena: crtež je nacrtan u  
negativu, a inkrustacija je označena  
crno.
- 94.** inv. 7866, kv. 15, dub. 5,50  
(sl. 30, 42)  
Ulomak plitke zdjele, uvučena vrata  
i zaobljena dna. Bogato je ukrašen  
donji dio zdjele, podijeljen u dva  
polja (dva nedostaju). Tamnosive  
boje, uglačane površine.  
Dimenzije:  $\emptyset$  ruba 18,5 cm, vis. 5,3  
m, deblj. stijenke 0,4 cm  
Lit.: Dimitrijević 1956: T. VII:  
44; Dimitrijević 1977-78: T. 8:5;  
Dimitrijević 1979c: T. XXXI:2;
- Marković 1994: T. 33:5; Tasić 1995:  
T. XXXI:5; Orion 2000: kat. br. 13.  
Napomena: crtež je nacrtan  
u negativu, a inkrustacija je  
označena crno.
- 95.** inv. 5880  
Ulomak plitke zdjele izvijena ruba  
i naglašena ramena. Oker boje,  
djelomično uglačane površine.  
Ukras u obliku trake nalazi se na  
ramenu posude.  
Dimenzije: 8 x 9,4 cm, deblj. sti-  
jenke 0,5 cm  
Lit.: Hoffiller 1938: T. 7:13.
- 96.** inv. 5686  
Plitka zdjela, omphalos dna i  
izvijena ruba. Ukrašen je na rame-  
nu posude. Svijetlosmeđe boje,  
djelomično uglačane površine.  
Dimenzije:  $\emptyset$  ruba 16,5 cm, vis. 5  
cm, deblj. stijenke 0,5 cm  
Lit.: Hoffiller 1938: T. 5:8.
- 97.** inv. 7858, kv. 19, dub. 4,00  
Plitka zdjela, zaobljena dna i izvi-  
jena ruba. Ukrašen je na ramenu  
posude ispunjen inkrustacijom.  
Oker boje, djelomično uglačane  
površine. Polovica posude je  
rekonstruirana.  
Dimenzije:  $\emptyset$  ruba 12 cm, vis. 2,7  
cm, deblj. stijenke 0,25 cm  
Lit.: Dimitrijević 1956: T. VIII:  
47; Dimitrijević 1977-78, T. 8:3;  
Marković 1994: T. 33:4.
- 98.** inv. 4936  
Ulomak plitke zdjele, naglašena  
ramena. Na ramenu je ukrašen  
ispunjen inkrustacijom. Unutarnja  
je stijenka tamnosive, a vanjska  
sive boje; djelomično uglačane  
površine.  
Dimenzije: 6,8 x 3,5 cm, deblj.  
stijenke 0,5 cm
- 99.** inv. 20374, kv. 19, dub. 4,70  
Plitka zdjelica s omphalos dnom,  
blago izvijena ruba i naglašena  
ramena. Oker boje, glatke  
površine. Rekonstruirana.  
Dimenzije:  $\emptyset$  ruba 8,6 cm, vis. 2,6  
cm, deblj. stijenke 0,3 cm
- 100.** inv. 1507  
Konična zdjelica bez izražena dna.  
Ima omphalos dno, oko kojega je  
urezivanjem i žigosanjem izveden  
motiv sunca. Unutarnja površina  
je tamnosive, a vanjska oker-sive  
boje; glatke, mat površine.  
Dimenzije: vis. 2,5 cm,  $\emptyset$  ruba 7,9  
cm, deblj. stijenke 0,3-0,5 cm  
Lit.: Hoffiller 1938: T. 5:7.
- 101.** inv. 7857, kv. A, dub. 2,60  
Duboka zdjela kratka izvijena

- sel's shoulder a decoration is made by nail and a tunnel-shaped lug on the one and a tunnel-shaped handle on the other side. Light grey. Dimensions: ht. 20 cm, rim diameter 15,4 cm, base diameter 9,2 cm, wall width 0,6 cm
- 81.** inv. 7846, q. 13, depth. 4,40  
An S-profiled pot with a ring-shaped base. Ochre-brown, polished surface. Decorated by notching and stabbing filled with white encrustation. Dimensions: ht. 20,6, rim diameter 13,8, base diameter 9,3, wall width 0,4 cm  
Lit.: Dimitrijević 1956: T. VIII:45; Dimitrijević 1977–78: fig. 2:9, T. 8:6; Dimitrijević 1979c: T. XXX:3; Marković 1994: T. 34:4; Die Neandertaler 1994: 121, cat. No. V 9; Tasić 1995: T. XXX:4; Orion 2000: cat. No. 28.
- 82.** inv. 5875  
A fragment of an S-profiled pot, ochre, partly polished surface. The decoration is made by grooved incision and notching filled with encrustation. Dimensions: pot diameter 12 cm, wall width 0,6 cm  
Lit.: Hoffiller 1938: T. 6:4
- 83.** inv. 4931  
A fragment of a rounded, deep bowl, dark brown, matte surface. Dimensions: rim diameter 32 cm, wall width 0,8 cm
- 84.** inv. 4931  
A fragment of a rounded, deep bowl, reddish-brown, partly polished surface. Dimensions: rim diameter 30 cm, wall width 0,5 cm
- 85.** inv. 4834  
A fragment of a rounded, deep bowl, dark brown, matte surface. Dimensions: 10,8 x 6,5 cm, wall width 1 cm
- 86.** inv. 4834  
A fragment of a rounded, deep bowl, dark grey, matte surface. Dimensions: 11,6 x 7,7 cm, wall width 1 cm
- 87.** inv. 4834  
A fragment of a rounded, deep bowl, dark grey, matte surface. Dimensions: 13,3 x 8,2 cm, wall width 1,1 cm
- 88.** inv. 4931  
A fragment of a rounded, deep bowl, dark brown, matte surface. The rim is decorated by incision. Dimensions: rim diameter 27,8 cm, wall width 1 cm
- 89.** inv. 4931  
A fragment of a rounded, deep bowl, dark brown, matte surface. Dimensions: rim diameter 34 cm, wall width 1 cm
- 90.** inv. 7860, q. 14, depth. 3,10  
A shallow bowl with a gently indent neck and a rounded base. The body is decorated by grooved incision filled with encrustation. The base is divided into four fields. Dark grey, polished surface. Dimensions: diameter 20,6, ht. 6 cm, wall width 0,5 cm  
Lit.: Dimitrijević 1977–78: T. 8:4; Dimitrijević 1979c: T. XXX:5; Katalog AMZ 1993: cat. No. 13a; Marković 1994: T. 34:7; Die Neandertaler 1994: 121, cat. No. V 4; Orion 2000: cat. No. 4.  
Note: The drawing is performed in negative: the encrustation is marked black
- 91.** inv. 5874  
A fragment of a shallow bowl with a gently extended rim. The lower vessel section is decorated by notching. The exterior is brown, the interior dark grey, polished surface. Dimensions: rim diameter 15 cm, ht. 4 cm, wall width 0,4 cm  
Lit.: Hoffiller 1938: T. 5:6, T. 7:15 (Note: two fragments of the same bowl have been published)
- 92.** inv. 5880  
A fragment of a shallow bowl with a gently extended rim. The decoration is placed at the shoulder in the shape of a band. Ochre-grey, matte surface. Dimensions: rim diameter 20 cm, ht. 5,4 cm, wall width 0,6 cm  
Lit.: Hoffiller 1938: T. 8:9.
- 93.** inv. 7861, q. 19, depth. 4,10 (fig. 28)  
A shallow bowl with a gently indent neck and omphalos base. The body is decorated by grooved incision filled with encrustation. The base is divided into four fields. Dark grey, polished surface. Dimensions: diameter 16,8, ht. 4,8 cm, wall width 0,4 cm  
Lit.: Katalog AMZ 1993: cat. No. 13b; Die Neandertaler 1994: 121, cat. No. V 5; Orion 2000: cat. No. 3.  
Note: The drawing is performed in negative: the encrustation is marked black
- 94.** inv. No. 7866, q. 15, depth. 5,50 (fig. 30, 42)  
A fragment of a shallow bowl with a gently indent rim and rounded base. The vessel's base is richly decorated, divided into two fields (two are missing). Dark grey, matte surface. Dimensions: rim diameter 18,5 cm, ht. 5,3 m, wall width 0,4 cm  
Lit.: Dimitrijević 1956: T. VII: 44; Dimitrijević 1977–78: T. 8:5; Dimitrijević 1979c: T. XXXI:2; Marković 1994: T. 33:5; Tasić 1995: T. XXXI:5; Orion 2000: cat. No. 13.  
Note: The drawing is performed in negative: the encrustation is marked black
- 95.** inv. 5880  
A fragment of a shallow bowl with an everted rim and accentuated shoulders. Ochre, partly polished surface. The decoration is made in the form of a band at the vessel's shoulder. Dimensions: 8 x 9,4 cm, wall width 0,5 cm  
Lit.: Hoffiller 1938: T. 7:13.
- 96.** inv. 5686  
A shallow bowl with omphalos base and everted rim. The decoration is placed at the vessel's shoulder. Light brown, partly polished surface. Dimensions: rim diameter 16,5 cm, ht. 5 cm, wall width 0,5 cm  
Lit.: Hoffiller 1938: T. 5:8.
- 97.** inv. 7858, q. 19, depth. 4,00  
A shallow bowl with a rounded base and everted rim. The decoration at the vessel's shoulder is filled with encrustation. Ochre, partly polished surface. One half of the vessel is reconstructed. Dimensions: rim diameter 12 cm, ht. 2,7 cm, wall width 0,25 cm  
Lit.: Dimitrijević 1956: T. VIII: 47; Dimitrijević 1977–78, T. 8:3; Marković 1994: T. 33:4.
- 98.** inv. 4936  
A shallow bowl with accentuated shoulders. The decoration at the vessel's shoulders is filled with encrustation. The interior is dark grey, the exterior grey, partly polished surface. Dimensions: 6,8 x 3,5 cm, wall width 0,5 cm
- 99.** inv. 20374, q. 19, depth. 4,70  
A shallow bowl with omphalos base, an everted rim and accentuated shoulders. Ochre, matte surface. Reconstructed. Dimensions: pr. 8,6 cm, ht. 2,6 cm, wall width 0,3 cm

vrata, prstenasta ruba, naglašena ramena i ravna dna. Na ramenu je ukras u traci, podijeljen na polja, od kojih je svako drugo potpuno prekriveno bijelom inkrustacijom. Vratni segment posude također je ukrašen. Tamnosmeđe boje, uglačane površine.

Dimenzije: vis. 7,4 cm,  $\varnothing$  ruba 22,7 cm,  $\varnothing$  dna 5,6 cm, deblj. stijenke 0,7 cm

Lit.: Die Neandertaler 1994: 120, kat. br. V 3.

**102.** inv. 20375, kv. 3, dub. 0,90

Ulomak zdjele izvučena ruba i naglašena ramena. Prstenasto izvučen rub. Ukras je izveden na ramenu rovašenjem u obliku trake. Tamnosive boje, uglačane površine.

Dimenzije: 9,5 x 6,2 cm, deblj. stijenke 0,6 cm

**103.** inv. 6196

Ulomak zdjele izvučena ruba i naglašena ramena. Prstenasto izvučen rub. Ukras je izveden na ramenu u obliku trake, rovašenjem ispunjenim inkrustacijom. Oker boje, uglačane površine.

Dimenzije: 8,1 x 7 cm, deblj. stijenke 0,6 cm

Lit.: Hoffiller 1938: T. 5:4.

**104.** inv. 5880

Ulomak zdjele izvučena ruba i naglašena ramena. Ukras je izveden na ramenu u uskoj traci. Tamnosive boje, uglačane površine.

Dimenzije: 4,5 x 4,6 cm, deblj. stijenke 0,5 cm

Lit.: Hoffiller 1938: T. 7:14 (napomena: objavljena fotografija zrcalno je okrenuta).

**105.** inv. 5880

Ulomak zdjele izvučena ruba i naglašena ramena. Ukras je izveden na ramenu u uskoj traci. Tamnosive boje, uglačane površine.

Dimenzije: 3,4 x 3,5 cm, deblj. stijenke 0,5 cm

Lit.: Hoffiller 1938: T. 8:16.

**106.** inv. 5880

Ulomak zdjele izvučena ruba i naglašena ramena. Ukras je izveden na ramenu u uskoj traci. Tamnosive boje, uglačane površine.

Dimenzije: 3,6 x 3,6 cm, deblj. stijenke 0,5 cm

Lit.: Hoffiller 1938: T. 8:13.

**107.** inv. 5880

Ulomak zdjele izvučena ruba i naglašena ramena. Ukras je izveden na ramenu u uskoj traci, a ukrašen je i pojas između ruba i ramena. Vanjska površina je oker, s unutarnja tamnosive boje; uglačane površine.

Dimenzije: 5,7 x 4,3 cm, deblj. stijenke 0,6 cm

Lit.: Hoffiller 1938: T. 8:12.

**108.** inv. 5880

Ulomak zdjele izvučena ruba i naglašena ramena. Ukras je izveden na ramenu. Vidljiva je inkrustacija. Tamnosive boje, uglačane površine.

Dimenzije: 6,2 x 4,4 cm, deblj. stijenke 0,4 cm

**109.** inv. 4936

Ulomak zdjele izvučena ruba. Ukras je izveden na ramenu u obliku trake te na vratnom segmentu. Rub je ukrašen s vanjske i unutarnje strane. Djelomično je vidljiva inkrustacija. Oker boje, uglačane površine.

Dimenzije: 4,6 x 2,1 cm, deblj. stijenke 0,4 cm

Lit.: Hoffiller 1938: T. 8:15.

**110.** inv. 4678

Ulomak zdjele S-profilacije. Tamnosive, djelomično uglačane površine.

Dimenzije:  $\varnothing$  ruba 25,8 cm, deblj. stijenke 0,7 cm

**111.** inv. 7873, kv. 2, dub. 2,60

Ulomak zdjele S-profilacije, s plastičnom gredastom drškom na ramenu. Tamnosive boje, uglačane površine. Ukrašen je vratni segment metopama i trakama izvedenim dubokim urezivanjem i rovašenjem.

Dimenzije: deblj. stijenke 1 cm

Lit.: Orion 2000: kat. br. 48.

**112.** inv. 4936

Ulomak zdjele S-profilacije, blago izvučena ramena i s gredastom izbočinom na ramenu. Smeđesive boje, djelomično uglačane površine. Vratni segment je ukrašen rovašenjem ispunjenim inkrustacijom.

Dimenzije: 10,2 x 10,8 cm, deblj. stijenke 0,8 cm

Lit.: Hoffiller 1938: T. 7:11.

**113.** inv. 7881, kv. 14, dub. 3,25 (sl. 41)

Ulomak zaobljena donjega dijela zdjele ukrašene rovašenim motivom romba. Oker boje, djelomično uglačane površine.

Dimenzije: deblj. stijenke 0,8 cm

**114.** inv. 5880

Ulomak zaobljena donjega dijela zdjele ukrašene rovašenim motivom rombova. Tamnosmeđe boje, mat, glatke površine.

Dimenzije: 9,8 x 9,5 cm, deblj. stijenke 0,9 cm

**115.** inv. 5877

Ulomak donjega dijela zdjele naglašena, bikonična prijeloma. Ukras je izveden rovašenjem ispunjenim inkrustacijom. Tamnosive boje, djelomično uglačane površine.

Dimenzije: 5,5 x 5,7 cm, deblj. stijenke 0,7 cm

Lit.: Hoffiller 1938: T. 8:4.

**116.** inv. 5880

Ulomak donjega dijela zdjele naglašena, bikonična prijeloma. Ukras je izveden brazdastim urezivanjem ispunjenim inkrustacijom. Smeđe boje, djelomično uglačane površine.

Dimenzije: 6,3 x 4,1 cm, deblj. stijenke 0,6 cm

**117.** inv. 7851, kv. 9, dub. 2,20

Posuda bikonična prijeloma (terina) s tunelastom ručkom na ramenu. Rame i ručka ukrašeni su brazdastim urezivanjem, a ispod ruba je ukras izveden ubadanjem. Tamnosive boje, uglačane površine. Posuda je većim dijelom rekonstruirana.

Dimenzije: vis. 7,5 cm,  $\varnothing$  ruba 10,6 cm,  $\varnothing$  dna 4 cm, deblj. stijenke 0,4 cm

**118.** inv. 7850, kv. 15, dub. 2,50

Posuda bikonična prijeloma (terina) s tunelastom ručkom na ramenu. Donji dio posude ukrašen je brazdastim urezivanjem. Smeđe boje, djelomično uglačane površine.

Dimenzije: vis. 7,5 cm,  $\varnothing$  ruba 10,3 cm,  $\varnothing$  dna 5,2 cm, deblj. stijenke 0,4 cm

**119.** inv. 20376, kv. 10a, dub. 2,00

Posuda bikonična prijeloma (terina) s tunelastom ručkom na ramenu. Na ramenu posude rovašenjem su izvedeni motivi trokuta postavljeni u skupine od po tri. Tamnosive boje, uglačane površine.

Dimenzije: vis. 12,8 cm,  $\varnothing$  ruba 15,6 cm,  $\varnothing$  dna 4,8 cm.

Lit.: Dimitrijević 1979c: T. XXX:9; Tasić 1995: T. XXVII:3.

**120.** inv. 7849, kv. 23, dub. 4,90 (sl. 31)

Posuda bikonična prijeloma (terina) s trakastom ručkom koja spaja

- 100.** inv. 1507  
A conical bowl with an accentuated base. Around the omphalos base the motif of the Sun is made by incision and notching. The interior is dark grey, the exterior ochre-grey, matte surface. Dimensions: ht. 2,5 cm, rim diameter 7,9 cm, wall width 0,3–0,5 cm  
Lit.: Hoffiller 1938: T.5:7.
- 101.** inv. 7857, q. A, depth. 2,60  
A deep bowl with a short, everted neck, a ring-shaped rim, accentuated shoulders and flat base. The neck section is decorated by notching. At the shoulder a band-shaped decoration is placed and divided into fields. Every second field is filled with encrustation. Dark brown, polished surface. Dimensions: ht. 7,4 cm, rim diameter 22,7 cm, base diameter 5,6 cm, wall width 0,7 cm  
Lit.: Die Neandertaler 1994: 120, cat. No. V 3.
- 102.** inv. 20375, q. 3, depth. 0,9  
A fragment of a bowl with an extended rim and accentuated shoulders. The rim is extended in a ring-like shape. The shoulder section is decorated in the form of a band by notching. Dark grey, polished surface. Dimensions: 9,5 x 6,2 cm, wall width 0,6 cm
- 103.** inv. 6196  
A fragment of a bowl with an extended rim and accentuated shoulders. The rim is extended in a ring-like shape. The shoulder section is decorated in the form of a band by notching filled with encrustation. Ochre, polished surface. Dimensions: 8,1 x 7 cm, wall width 0,6 cm  
Lit.: Hoffiller 1938: T. 5:4.
- 104.** inv. 5880  
A fragment of a bowl with an extended rim and accentuated shoulders. The shoulder section is decorated in the form of a band. Dark grey, polished surface. Dimensions: 4,5 x 4,6 cm, wall width 0,5 cm  
Lit.: Hoffiller 1938: T. 7:14 (note: the published photo is mirror-turned).
- 105.** inv. 5880  
A fragment of a bowl with an extended rim and accentuated shoulders. The shoulder section is decorated in the form of a band.
- Dark grey, polished surface. Dimensions: 3,4 x 3,5 cm, wall width 0,5 cm  
Lit.: Hoffiller 1938: T. 8:16.
- 106.** inv. 5880  
A fragment of a bowl with an extended rim and accentuated shoulders. The shoulder section is decorated in the form of a band. Dark grey, polished surface. Dimensions: 3,6 x 3,6 cm, wall width 0,5 cm  
Lit.: Hoffiller 1938: T. 8:13.
- 107.** inv. 5880  
A fragment of a bowl with an extended rim and accentuated shoulders. The shoulder section is decorated in the form of a band. The exterior is ochre, the interior is dark grey, polished surface. Dimensions: 5,7 x 4,3 cm, wall width 0,6 cm  
Lit.: Hoffiller 1938: T. 8:12.
- 108.** inv. 5880  
A fragment of a bowl with an extended rim and accentuated shoulders. The shoulder section is decorated in the form of a band. The encrustation is visible. Dark grey, polished surface. Dimensions: 6,2 x 4,4 cm, wall width 0,4 cm
- 109.** inv. 4936  
A fragment of a bowl with an extended rim. The neck and shoulder section is decorated in the form of a band. Partly visible encrustation. Ochre, polished surface. Dimensions: 4,6 x 2,1 cm, wall width 0,4 cm  
Lit.: Hoffiller 1938: T. 8:15.
- 110.** inv. 4678  
A fragment of an S-profiled bowl, dark grey, partly polished surface. Dimensions: bowl diameter 25,8 cm, wall width 0,7 cm
- 111.** inv. 7873, q. 2, depth. 2,60  
A fragment of an S-profiled bowl, with a relief applied beam-like handle at the shoulder. Dark grey, polished surface. The neck section is decorated with metopes and bands by deep incision and notching. Dimensions: wall width 1 cm  
Lit.: Orion 2000: cat. No. 48.
- 112.** in. 4936  
A fragment of an S-profiled bowl with gently extended shoulders and a beam-like extrusion at the shoulder. Brown-grey, partly polished surface. The neck section is decorated by notching filled with encrustation. Dimensions: 10,2 x 10,8 cm, wall width 0,8 cm  
Lit.: Hoffiller 1938: T. 7:11.
- 113.** inv. 7881, q. 14, depth. 3,25 (fig. 41)  
A fragment of the rounded lower section (base) of a bowl, decorated by notching with rhombus motives. Ochre, partly polished surface. Dimensions: wall width 0,8 cm
- 114.** inv. 5880  
A fragment of the rounded lower section (base) of a bowl, decorated by notching with rhombus motives. Dark brown, matte surface. Dimensions: 9,8 x 9,5 cm, wall width 0,9 cm
- 115.** inv. 5877  
A fragment of the lower section of a bowl with an accentuated, biconical break. The decoration is made by notching filled with encrustation. Dark grey, partly polished surface. Dimensions: 5,5 x 5,7 cm, wall width 0,7 cm  
Lit.: Hoffiller 1938: T. 8:4.
- 116.** inv. 5880  
A fragment of the lower section of a bowl with an accentuated, biconical break. The decoration is made by grooved incision filled with encrustation. Brown, partly polished surface. Dimensions: 6,3 x 4,1 cm, wall width 0,6 cm
- 117.** inv. 7851, q. 9, depth. 2,20  
A vessel with a biconical break (terrine) and a tunnel-shaped handle at the shoulder. The shoulder and handle are decorated by grooved incision whereas below the rim the decoration is made by stabbing. Dark grey, polished surface. The vessel is mainly reconstructed. Dimensions: ht. 7,5 cm, rim diameter 10,6 cm, base diameter 4 cm, wall width 0,4 cm
- 118.** inv. 7850, q. 15, depth. 2,50  
A vessel with a biconical break (terrine) and a tunnel-shaped handle at the shoulder. The lower section is decorated by grooved incision. Brown, partly polished surface. Dimensions: ht. 7,5 cm, rim diameter 10,3 cm, base diameter 5,2 cm, wall width 0,4 cm

- rub i bikonični prijelom. Vratni segment i ručka ukrašeni su brazdastim urezivanjem. Tamnosive boje, uglačane površine. Velik dio je rekonstruiran.  
Dimenzije: vis. 9 cm,  $\emptyset$  ruba 12,4 cm,  $\emptyset$  dna 4,7 cm, deblj. stijenke 0,4 cm  
Lit.: Dimitrijević 1977–78: T. 8:2; Marković 1994: T. 33:1; Die Neandertaler 1994: 122, kat. br. V 14.
- 121.** inv. 7855, kv. 23, dub. 2,10  
Dio bikonične posude (terine) s trakastom ručkom koja spaja rub i bikonični prijelom. Vratni segment i ručka ukrašeni su brazdastim urezivanjem. Tamnosive boje, djelomično uglačane površine.  
Dimenzije:  $\emptyset$  ruba 13,5 cm, deblj. stijenke 0,5 cm
- 122.** inv. 6553  
Trakasta ručka tamnosive boje, djelomično uglačane površine. Ukras je izveden brazdastim urezivanjem.  
Dimenzije: 5,5 x 8,7 cm  
Lit.: Hoffiller 1938: T. 10:14.
- 123.** inv. 7883, kv. 7, dub. 3,80  
Tunelasta ručka oker boje, uglačane površine.  
Dimenzije: 11,8 x 6,2 cm  
Lit.: Dimitrijević 1977–78: T. 9:6; Dimitrijević 1979c: T. XXXI:6, Tasić 1995: T. XXXI:3; Orion 2000: kat. br. 12.
- 124.** inv. 7892, kv. 19, dub. 5,20  
Tunelasta ručka. Tamnosive boje, uglačane površine. Ukras je izveden rovašenjem ispunjenim inkrustacijom.  
Dimenzije: 6,3 x 6,5 cm
- 125.** inv. 6386  
Tunelasta ručka. Tamnosmeđe boje, uglačane površine.  
Dimenzije: 7,3 x 4,6 cm, deblj. stijenke 0,6 cm  
Lit.: Hoffiller 1938: T. 10:18
- 126.** inv. 5881  
Tunelasta ručka. Sive boje, djelomično uglačane površine. Djelomično je vidljiva inkrustacija.  
Dimenzije: 7,7 x 4,6 cm, deblj. stijenke 0,7 cm  
Lit.: Hoffiller 1938: T. 10:10
- 127.** inv. 5881  
Tunelasta ručka. Tamnosive boje, uglačane površine, ukrašena rovašenjem ispunjenim inkrustacijom.  
Dimenzije: 5,4 x 5,6 cm; deblj. stijenke 0,6 cm  
Lit.: Hoffiller 1938: T.10:17.
- 128.** inv. 6553  
Tunelasta ručka. Tamnosive boje, glatke, mat površine. Ukras je ispunjen inkrustacijom.  
Dimenzije: 7,2 x 5,1 cm, deblj. stijenke 0,7 cm  
Lit.: Hoffiller 1938: T. 10:12.
- 129.** inv. 6195  
Ulomak trbuha bikonične posude (terine) s tunelastom ručkom. Oker-smeđe boje, djelomično uglačane površine.  
Dimenzije: 11,8 x 6,8 cm, deblj. stijenke 0,6 cm  
Lit.: Hoffiller 1938: T. 10:11.
- 130.** inv. 5881  
Tunelasta ručka. Oker boje, glatke, mat površine. Mjestimično je vidljiva bijela inkrustacija.  
Dimenzije: 10 x 6,9 cm  
Lit.: Hoffiller 1938: T.10:6,7 (napomena: dva ulomka koja su objavljena pripadaju istoj ručki)
- 131.** inv. 7887, kv. 14, dub. 4,10  
Tunelasta ručka. Tamnosive boje, glatke, mat površine, ukrašena dubokim urezivanjem.  
Dimenzije: 7,6 x 4,8 cm
- 132.** inv. 7890, kv. 14, dub. 3,10  
Široka trakasta ručka. Tamnosive boje, glatke, mat površine. Rovašeni ukras ispunjen je inkrustacijom.  
Dimenzije: 6,3 x 5,9 cm
- 133.** inv. 7889, kv. 4, dub. 4,40  
Tunelasta ručka. Tamnosive boje, glatke, mat površine. Rovašeni ukras ispunjen je bijelom inkrustacijom.  
Dimenzije: 8,3 x 4,3 cm
- 134.** inv. 7888, kv. 25, dub. 2,00  
Tunelasta ručka. Crvene boje, slabo zaglađene površine.  
Dimenzije: 8,2 x 4,9 cm
- 135.** inv. 7893, kv. 18, dub. 5,30  
Tunelasta ručka. Tamnosive boje, uglačane površine. Rovašeni ukras ispunjen je inkrustacijom.  
Dimenzije: 6,7 x 5 cm, deblj. stijenke posude 0,5 cm
- 136.** inv. 7891, kv. 15, dub. 2,30  
Tunelasta ručka. Smeđe boje, uglačane površine. Rovašeni ukras ispunjen je inkrustacijom.  
Dimenzije: 6,6 x 4,7 cm, deblj. stijenke posude 0,6 cm
- 137.** inv. 7885, kv. 3/4, dub. 2,40  
Tunelasta ručka. Smeđe boje, glatke, mat površine. Rovašenjem su izvedeni rombovi ispunjeni bijelom inkrustacijom.  
Dimenzije: 7,4 x 4,3, deblj. stijenke posude 0,6 cm
- 138.** inv. 7886, kv. 8, dub. 5,20  
Tunelasta ručka. Tamnosive, uglačane površine. Ukrašena rovašenjem.  
Dimenzije: 6,2 x 5,5 cm, deblj. stijenke posude 0,5 cm
- 139.** inv. 7884, kv. 24, dub. 4,20  
Tunelasta ručka. Tamnosive boje, glatke, mat površine.  
Dimenzije: 9,3 x 4,9 cm
- 140.** inv. 7870, kv. 18, dub. 3,70  
Ulomak bikonična prijeloma s ukrasom sunca izvedenim rovašenjem. Unutarnja strana je tamnosive, a vanjska oker boje; glatke, mat površine.  
Dimenzije: deblj. stijenke 0,4 – 0,6 cm
- 141.** inv. 20377, kv. 8, dub. 0,75  
Ulomak ramena posude s ukrasom sunca izvedenim rovašenjem. Tamnosmeđe, glatke površine.  
Dimenzije: 7,4 x 4 cm, deblj. stijenke 0,4 cm
- 142.** inv. 4936  
Ulomak bikonična prijeloma. Tamnosive boje, djelomično uglačane površine. Ukras je na prijelomu u obliku trake.  
Dimenzije: 5,5 x 3,5 cm, deblj. stijenke 0,5 cm
- 143.** inv. 20377, kv. 9, dub. 1,7 cm  
Ulomak bikonična prijeloma s rovašenjem izvedenim solarnim motivom. Vanjska površina je smeđe, a unutarnja tamnosive boje; uglačane površine.  
Dimenzije: 6 x 4 cm, deblj. stijenke 0,8 cm
- 144.** inv. 4936  
Ulomak bikonična prijeloma, s rovašenjem izvedenim solarnim motivom ispunjenim inkrustacijom. Vanjska površina je smeđe-oker, a unutarnja tamnosive boje; uglačane površine.  
Dimenzije: 12,2 x 9,2 cm, deblj. stijenke 0,4 cm  
Lit.: Hoffiller 1938: T. 6:8.
- 145.** inv. 4519  
Ulomak bikonična prijeloma s rovašenjem izvedenim solarnim motivom ispunjenim inkrustacijom. Tamnosive boje, glatke, mat površine.  
Dimenzije: 11,1 x 6,2 cm, deblj. stijenke 0,6 cm  
Lit.: Hoffiller 1938: T. 6:7.

- 119.** inv. 20376, q. 10a, depth. 2,00  
A vessel with a biconical break (terrine) and a tunnel-shaped handle at the shoulder. The shoulder section is decorated with motives of triangles assembled in groups of three made by notching. Dark grey, polished surface.  
Dimensions: ht. 12,8 cm, rim diameter 15,6 cm, base diameter 4,8 cm.  
Lit.: Dimitrijević 1979c: T. XXX:9; Tasić 1995: T. XXVII:3.
- 120.** inv. 7849, q. 23, depth. 4,90 (fig. 31)  
A vessel with a biconical break (terrine) and a banded handle connecting the rim to the biconical break. The neck section and the handle are decorated by grooved incision. Dark grey, polished surface, mostly reconstructed. Dimensions: ht. 9 cm, rim diameter 12,4 cm, base diameter 4,7 cm, wall width 0,4 cm  
Lit.: Dimitrijević 1977–78: T. 8:2; Marković 1994: T. 33:1; Die Neandertaler 1994: 122, cat. No. V 14.
- 121.** inv. 7855, q. 23, depth. 2,10  
A fragment of a biconical vessel (terrine) with a banded handle connecting the rim to the biconical break. The neck section and the handle are decorated by grooved incision. Dark grey, partly polished surface.  
Dimensions: rim diameter 13,5 cm, wall width 0,5 cm
- 122.** inv. 6553  
A banded handle, dark grey, partly polished surface. The decoration is made by grooved incision.  
Dimensions: 5,5 x 8,7 cm  
Lit.: Hoffiller 1938: T.10:14.
- 123.** inv. 7883, q. 7, depth. 3,80  
A tunnel-shaped handle, ochre, polished surface.  
Dimensions: 11,8 x 6,2 cm  
Lit.: Dimitrijević 1977–78: T. 9:6; Dimitrijević 1979c: T. XXXI:6; Tasić 1995: T. XXXI:3; Orion 2000: cat. No. 12.
- 124.** inv. 7892, q. 19, depth. 5,20  
A tunnel-shaped handle, dark grey, polished surface. The decoration is made by notching filled with encrustation.  
Dimensions: 6,3 x 6,5 cm
- 125.** inv. 6386  
A tunnel-shaped handle, dark brown, polished surface.  
Dimensions: 7,3 x 4,6 cm, wall width 0,6 cm
- 126.** inv. 5881  
Tunnel-shaped handle, grey, partly polished surface. The encrustation is partly visible.  
Dimensions: 7,7 x 4,6 cm, wall width 0,7 cm  
Lit.: Hoffiller 1938: T.10:10
- 127.** inv. 5881  
A tunnel-shaped handle, dark grey, polished surface. The decoration is made by notching filled with encrustation.  
Dimensions: 5,4 x 5,6 cm; wall width 0,6 cm  
Lit.: Hoffiller 1938: T.10:17.
- 128.** inv. 6553  
A tunnel-shaped handle, dark grey, matte surface. The decoration is filled with encrustation.  
Dimensions: 7,2 x 5,1 cm, wall width 0,7 cm  
Lit.: Hoffiller 1938: T.10:12.
- 129.** inv. 6195  
A fragment of a biconical vessel (terrine) bell with a tunnel-shaped handle, ochre-brown, partly polished surface.  
Dimensions: 11,8 x 6,8 cm, wall width 0,6 cm  
Lit.: Hoffiller 1938: T.10:11.
- 130.** inv. 5881  
A tunnel-shaped handle, ochre, matte surface. Sporadically visible white encrustation.  
Dimensions: 10 x 6,9 cm  
Lit.: Hoffiller 1938: T.10:6,7 (two published fragments belong to the same handle)
- 131.** inv. 7887, q. 14, depth. 4,10  
A tunnel-shaped handle, dark grey, matte surface, decorated by deep incision.  
Dimensions: 7,6 x 4,8 cm
- 132.** inv. 7890, q. 14, depth. 3,10  
A broad-banded dark grey handle, matte surface. The notched decoration is filled with encrustation  
Dimensions: 6,3 x 5,9 cm
- 133.** inv. 7889, q. 4, depth. 4,40  
A tunnel-shaped handle, dark grey, matte surface, decorated by notching filled with white encrustation.  
Dimensions: 8,3 x 4,3 cm
- 134.** inv. 7888, q. 25, depth. 2,00  
A tunnel-shaped handle, red, poorly polished surface.  
Dimensions: 8,2 x 4,9 cm
- 135.** inv. 7893, q. 18, depth. 5,30  
A tunnel-shaped handle, dark grey, polished surface, decorated by notching filled with encrustation.  
Dimensions: 6,7 x 5 cm, wall vessel width 0,5 cm
- 136.** inv. 7891, q. 15, depth. 2,30  
A tunnel-shaped handle, brown, polished surface, decorated by notching filled with encrustation.  
Dimensions: 6,6 x 4,7 cm, wall width of the vessel 0,6 cm
- 137.** inv. 7885, q. 3/4, depth. 2,40  
A tunnel-shaped handle, brown, matte surface, decorated with rhombus made by notching filled with white encrustation.  
Dimensions: 7,4 x 4,3, wall width of the vessel 0,6 cm
- 138.** inv. 7886, q. 8, depth. 5,20  
A tunnel-shaped handle, dark grey, polished surface, decorated by notching.  
Dimensions: 6,2 x 5,5 cm, vessel wall width 0,5 cm
- 139.** inv. 7884, q. 24, depth. 4,20  
A tunnel-shaped handle, dark grey, matte surface.  
Dimensions: 9,3 x 4,9 cm
- 140.** inv. 7870, q. 18, depth. 3,70  
A fragment of a biconical break with the decoration of the Sun made by notching. The interior is dark grey, the exterior ochre, matte surface. Dimensions: wall width 0,4 – 0,6 cm
- 141.** inv. 20377, q. 8, depth. 0,75  
A fragment of a vessel's shoulder with the decoration of the Sun made by notching. Dark brown, matte surface.  
Dimensions: 7,4 x 4 cm; wall width 0,4 cm
- 142.** inv. 4936  
A fragment of a biconical, dark grey, partly polished surface. The decoration is placed at the break in the form of a band.  
Dimensions: 5,5 x 3,5 cm, wall width 0,5 cm
- 143.** inv. 20377, q. 9, depth. 1,7 cm  
A fragment of a biconical break with a solar motif made by notching. The exterior is brown, the interior is dark grey, polished surface.  
Dimensions: 6 x 4 cm, wall width 0,8 cm
- 144.** inv. 4936  
A fragment of a biconical break



- 146.** inv. 7875, kv. 22, dub. 4,40  
Ulomak tijela posude s rovašenjem izvedenim solarnim motivom ispunjenim inkrustacijom. Tamnosive boje, uglačane površine. Dimenzije: deblj. stijenke 0,4 cm
- 147.** inv. 7872, kv. 2, dub. 4,20  
Ulomak tijela posude s rovašenjem izvedenim solarnim motivom ispunjenim inkrustacijom. Tamnosive boje, uglačane površine. Dimenzije: deblj. stijenke 0,4 cm
- 148.** inv. 7879, kv. 24, dub. 7,10 (sl. 41)  
Ulomak tijela posude s rovašenjem izvedenim solarnim motivom. Tamnosive boje, uglačane površine. Dimenzije: deblj. stijenke 0,6 – 0,8 cm
- 149.** inv. 6196  
Ulomak terine uglačane površine, ukrašene rovašenjem ispunjenim inkrustacijom. Unutarnja stijenka je tamnosive, a vanjska smeđe boje. Dimenzije: 6,3 x 4,5 cm, deblj. stijenke 0,5 cm  
Lit.: Hoffiller 1938: T. 6:2.
- 150.** inv. 6196  
Ulomak terine. Sive boje, uglačane površine; ukrašena rovašenjem ispunjenim inkrustacijom. Dimenzije: 4,9 x 4,3 cm, deblj. stijenke 0,7 cm  
Lit.: Hoffiller 1938: T. 6:11.
- 151.** inv. 5880  
Ulomak terine. Sive boje, glatke, mat površine. Ukrašena rovašenjem, a mjestimično je sačuvana inkrustacija. Dimenzije: 6,5 x 6,2 cm, deblj. stijenke 0,5 cm  
Lit.: Hoffiller 1938: T. 8:5.
- 152.** inv. 7852, kv. 10, dub. 1,60  
Šalica bikonična tijela i izvučena vrata, s izduženom ušicom na prijelomu. Žigosanim ubodima ispunjenim inkrustacijom ukrašena je čitava vanjska površina šalice, dio uz rub s unutarnje strane te ušica. Oker-smeđe boje. Dimenzije: vis. 6,9 cm, ø dna 3,5 cm, deblj. stijenke 0,6 cm  
Lit.: Dimitrijević 1977–78: T. 9:11; Katalog AMZ 1993: kat. br. 12; Die Neandertaler 1994: 121, kat. br. V 6; Muzeopis 1996: kat. br. 11.  
Napomena: nacrtan je idealan profil šalice, iako je njezin rub sasvim deformiran jer je gorjela.
- 153.** inv. 5872  
Šalica bikonična tijela i izvučena vrata, s tunelastom ručkom na prijelomu. Ukrašeno je rame posude te rub i ručka. Sive boje, glatke, mat površine. Dimenzije: vis. 6,9 cm, ø ruba 7,7 cm, ø dna 3,6 cm, deblj. stijenke 0,4 cm  
Lit.: Hoffiller 1938: T. 4:7.
- 154.** inv. 7853, kv. 10, dub. 1,60  
Šalica bikonična tijela i izvučena vrata, s izduženom ušicom na prijelomu. Rovašenjem je ukrašen čitav vratni segment površine šalice. Sivkasto-žute boje, djelomično uglačane površine. Dimenzije: vis. 7 cm, ø ruba 8 cm, ø dna 2,8 cm, deblj. stijenke 0,6 cm  
Lit.: Dimitrijević 1977–78: T. 9:12; Dimitrijević 1979c: T. XXX:8.
- 155.** inv. 1320  
Šalica bikonična tijela i izvučena vrata, s izduženom drškom na prijelomu. Rovašenjem je ukrašena čitava površina šalice, a drška urezivanjem. Tamnosive boje, uglačane površine. Dimenzije: vis. 4,4 cm, ø ruba 8,3 cm, ø dna 3 cm, deblj. stijenke 0,4 cm  
Lit.: Die Neandertaler 1994: 121, kat. br. V 7.
- 156.** inv. 7854, kv. 23, dub. 4,20  
Šalica bikonična tijela, izvučena vrata i zaobljena dna, s izduženom ručkom na prijelomu. Rovašenjem su ukrašeni prijelom i rub. Oker boje, djelomično uglačane površine. Dimenzije: vis. 4,5 cm, ø ruba 10,4 cm, deblj. stijenke 0,3 cm
- 157.** inv. 7899, kv. 15, dub. 2,60  
Zaobljena šalica s trakastom ručkom na trbuhu i prstenastim dnom. Oker boje, djelomično uglačane površine. Dimenzije: vis. 11,8 cm, ø ruba 10,4 cm, ø dna 7, deblj. stijenke 0,7 cm
- 158.** inv. 7871, kv. 8/9, dub. 3,00  
Ulomak lonca S-profilacije s trakastom ručkom pod rubom. Ukras je na najširem dijelu posude, na trbuhu, izveden brazdastim urezivanjem i rovašenjem ispunjenim inkrustacijom. Oker boje, djelomično uglačane površine. Dimenzije: deblj. stijenke 0,5 cm  
Lit.: Dimitrijević 1977–78: T. 9:9.
- 159.** inv. 7848, kv. 23, dub. 6,10  
Lonac S-profilacije ravna dna i s trakastom ručkom koja spaja rub i trbuh posude. Ukras na vratnom segmentu je u pojasu izveden brazdastim urezivanjem. Tamnosmeđe boje, djelomično uglačane površine. Dimenzije: vis. 14,4 cm, ø ruba 11,4 cm, ø dna 7 cm, deblj. stijenke 0,5 cm  
Lit.: Dimitrijević 1956: T. VIII:46; Dimitrijević 1977–78: T. 16:4; Dimitrijević 1979c: T. XXXI:3; Marković 1994: T. 33:6; Tasić 1995: T. XXX:1.
- 160.** inv. 7847, kv. 22, dub. 3,35 (sl. 33)  
Posuda bikonična tijela, kratka, izvučena prstenasta vrata i ravna dna, s dvjema ušicama na prijelomu. Tamnosive boje, uglačane površine. Ukras je izveden rovašenjem ispunjenim inkrustacijom na gornjem, ramenom dijelu posude. Dimenzije: vis. 10 cm, ø ruba 5,4 cm, ø dna 4 cm, deblj. stijenke 0,4 cm  
Lit.: Dimitrijević 1977–78: T. 9:5; Dimitrijević 1979c: T. XXXI:1; Marković 1994: T. 33:3; Die Neandertaler 1994: 125, kat. br. V 27; Tasić 1995: T. XXXI:1.
- 161.** inv. 5871  
Posuda bikonična tijela, kratka, izvučena prstenasta vrata i ravna dna, s dvjema ušicama na vratu. Tamnosmeđe boje, djelomično uglačane površine. Ukras je izveden brazdastim urezivanjem na gornjem dijelu posude. Posuda je rekonstruirana. Dimenzije: vis. 10 cm, ø ruba 5,4 cm, ø dna 4 cm, deblj. stijenke 0,4 cm  
Lit.: Hoffiller 1938: T. 4:2; Dimitrijević 1977–78: T. 8:1; Dimitrijević 1979c: T. XXX:7; Marković 1994: T. 34:2; Tasić 1995: T. XXX:3.
- 162.** inv. 7856, kv. 20, dub. 3,00  
Posudica zaobljena tijela i kratka cilindrična vrata, sivo-žute boje, djelomično uglačane površine. Ušice su postavljene na ramenu posude, a brazdastim urezivanjem ukrašeno je tijelo posude. Dimenzije: vis. 5,2 cm, ø ruba 4 cm, ø dna 3,5 cm, deblj. stijenke 0,3 cm  
Lit.: Die Neandertaler 1994: 124, kat. br. V 26.
- 163.** inv. 6196  
Šuplja zvonolika noga. Ukrašena brazdastim urezivanjem ispunjenim inkrustacijom. Tamnosive

with a solar motif made by notching filled with encrustation. The exterior is brown-ochre, the interior is dark grey, polished surface. Dimensions: 12,2 x 9,2 cm, wall width 0,4 cm  
Lit.: Hoffiller 1938: T.6:8.

**145.** inv. 4519

A fragment of a biconical break with a solar motif made by notching filled with encrustation. Dark grey, matte surface. Dimensions: 11,1 x 6,2 cm, wall width 0,6 cm  
Lit.: Hoffiller 1938: T.6:7.

**146.** inv. 7875, q. 22, depth. 4,40

A fragment of a vessel body with a solar motif made by notching filled with encrustation. Dark grey, polished surface. Dimensions: wall width 0,4 cm

**147.** inv. 7872, q. 2, depth. 4,20

A fragment of a vessel's body with a solar motif made by notching filled with encrustation. Dark grey, polished surface. Dimensions: wall width 0,4 cm

**148.** inv. 7879, q. 24, depth. 7,10 (fig. 41)

A fragment of a vessel's body with a solar motif made by notching filled with encrustation. Dark grey, polished surface. Dimensions: wall width 0,6 – 0,8 cm

**149.** inv. 6196

A fragment of a terrine decorated by notching filled with encrustation. The interior is dark grey, the exterior brown. Dimensions: 6,3 x 4,5 cm, wall width 0,5 cm  
Lit.: Hoffiller 1938: T.6:2.

**150.** inv. 6196

A fragment of a grey, polished terrine decorated by notching filled with encrustation. Dimensions: 4,9 x 4,3 cm, wall width 0,7 cm  
Lit.: Hoffiller 1938: T.6:11.

**151.** inv. 5880

A fragment of a terrine, grey, matte surface. Decorated by notching with sporadically preserved encrustation. Dimensions: 6,5 x 6,2 cm, wall width 0,5 cm  
Lit.: Hoffiller 1938: T.8:5.

**152.** inv. 7852, q. 10, depth. 1,60

A biconical cup with extended neck and an elongated lug at the break. The whole exterior of the

cup, the rim and the interior are decorated by notched stabblings filled with encrustation. Ochre-brown. The rim is deformed due to burning.

Dimensions: ht. 6,9 cm, base diameter 3,5 cm, wall width 0,6 cm  
Lit.: Dimitrijević 1977–78: T. 9:11; Katalog AMZ1993: cat. No. 12; Die Neandertaler 1994: 121, cat. No. V 6; Muzeopis 1996: cat. No. 11.

Remark: the ideal profile of the cup has been drawn, although its rim was completely deformed due to fire burning.

**153.** inv. 5872

A biconical cup with an extended neck and a tunnel-shaped handle at the break. The decoration is placed in the shape of a band at the broadest section of the vessel, likewise the rim and the handle. Grey, matte surface.

Dimensions: ht. 6,9 cm, rim diameter 7,7 cm, base diameter 3,6 cm, wall width 0,4 cm  
Lit.: Hoffiller 1938: T. 4:7.

**154.** inv. 7853, q. 10, depth. 1,60

A biconical cup with an extended neck and an elongated handle at the break. The whole neck section of the cup is decorated by notching. Grayish-yellow, partly polished surface.

Dimensions: ht. 7 cm, rim diameter 8 cm, base diameter 2,8 cm, wall width 0,6 cm  
Lit.: Dimitrijević 1977–78: T.9:12, Dimitrijević 1979c: T.XXX:8.

**155.** inv. 1320

A biconical cup with an extended neck and an elongated handle at the break. The whole cup surface is decorated by notching, the handle by incision. Dark grey, polished surface

Dimensions: ht. 4,4 cm, rim diameter 8,3 cm, base diameter 3 cm, wall width 0,4 cm  
Lit.: Die Neandertaler 1994: 121, cat. No. V 7.

**156.** inv. 7854, q. 23, depth. 4,20

A biconical cup with an extended neck, a rounded base and an elongated handle at the break. The break and the rim are decorated by notching. Ochre, partly polished surface.

Dimensions: ht. 4,5 cm, rim diameter 10,4 cm, wall width 0,3 cm

**157.** inv. 7899, q. 15, depth. 2,60

A rounded cup with a ring-

shaped base and a banded-handle at the belly. Ochre, partly polished surface.

Dimensions: ht. 11,8 cm, rim diameter 10,4 cm, base diameter 7, wall width 0,7 cm

**158.** inv. 7871, q. 8/9, depth. 3,00

A fragment of an S-profiled pot with a small banded handle below the rim. The decoration is placed at the broadest section of the vessel. At the belly the decoration is made by grooved incision and notching filled with encrustation. Ochre, partly polished surface.

Dimensions: wall width 0,5 cm  
Lit.: Dimitrijević 1977–78: T.9:9.

**159.** inv. 7848, q. 23, depth. 6,10

An S-profiled pot with a flat base and a banded handle connecting the rim to the vessel's belly. The decoration is made at the neck segment in the broad band by grooved incision. Dark brown, partly polished surface.

Dimensions: ht. 14,4 cm, rim diameter 11,4 cm, base diameter 7 cm, wall thickness 0,5 cm  
Lit.: Dimitrijević 1956: T. VIII:46; Dimitrijević 1977–78: T. 16:4; Dimitrijević 1979c: T. XXXI:3; Marković 1994: T. 33:6; Tasić 1995: T. XXX:1.

**160.** inv. 7847, q. 22, depth. 3,35 (fig. 33)

A biconical vessel with a short, extended ring-shaped neck, a flat base with two lugs at the break. The decoration is made by notching filled with encrustation at the upper, shoulder section of the vessel.

Dimensions: ht. 10 cm, rim diameter 5,4 cm, base diameter 4 cm, wall width 0,4 cm  
Lit.: Dimitrijević 1977–78: T. 9:5; Dimitrijević 1979c: T. XXXI:1; Marković 1994: T. 33:3; Die Neandertaler 1994: 125, cat. No. V 27; Tasić 1995: T. XXXI:1.

**161.** inv. 5871

A biconical vessel with a short, extended ring-shaped neck, a flat base with two lugs at the neck. The decoration is made by notching filled with encrustation at the upper section of the vessel. The vessel is reconstructed.

Dimensions: ht. 10 cm, rim diameter 5,4 cm, base diameter 4 cm, wall width 0,4 cm  
Lit.: Hoffiller 1938: T. 4:2, Dimitrijević 1977–78: T. 8:1, Dimitrijević 1979c: T. XXX:7,

boje, djelomično uglačane površine.  
Dimenzije: vis. 5,6 cm, deblj. stijenke 0,5 cm  
Lit.: Hoffiller 1938: T. 7:10.

**164.** inv. 6196

Zdjelica zaobljena tijela na četiri čepaste nožice (dviije su sačuvane). Ukrašena je rovašenjem. Žučkasto-oker boje, djelomično uglačane površine.  
Dimenzije:  $\varnothing$  ruba 4,7 cm, deblj. stijenke 0,35 cm  
Lit.: Hoffiller 1938: T. 8:21.

**165.** inv. 5873

Zdjela naglašena ramena i izvučena ruba, na četiri čepaste nožice (1 je sačuvana). Ukrašena je urezanom cik-cak linijom s unutarnje strane ispod ruba, a s vanjske je ukras na najširem dijelu te na dnu izveden rovašenjem ispunjenim inkrustacijom. Sive boje, glatke, mat površine.  
Dimenzije:  $\varnothing$  ruba 13,8 cm, debljina stijenke 0,4 cm  
Lit.: Hoffiller 1938: T. 7:5.

**166.** inv. 6553

Zdjela naglašena ramena i izvučena ruba, na četiri čepaste nožice (1 je sačuvana). S unutarnje strane ukrasena je ispod ruba linijom izvedenom brazdistim urezivanjem, a s vanjske se ukras nalazi na najširem dijelu u obliku trake te na dnu izveden rovašenjem ispunjenim inkrustacijom. Smeđe boje, glatke, mat površine.  
Dimenzije: 6,7 x 7,4 cm, debljina stijenke 0,6 cm  
Lit.: Hoffiller 1938: T. 7:7.

**167.** inv. 6196

Ulomak čepaste nožice. Tamnosive boje, glatke, mat površine.  
Dimenzije: deblj. stijenke 0,5 cm

**168.** inv. 6191

Zaobljena zdjela na križnoj nozi. Oker-smeđe boje, uglačane površine.  
Dimenzije: vis. 6,3 cm,  $\varnothing$  ruba 13,7 cm, šir. dna 6,4 cm, deblj. stijenke 0,7 cm  
Lit.: Hoffiller 1938: T.2: 10.

**169.** inv. 7862, kv. A, dub. 2,00

Konična, plitka zdjela na prstenastoj nozi. S unutarnje strane ukrasena je rovašenjem. Oker boje, uglačane površine.  
Dimenzije: vis. 4 cm,  $\varnothing$  ruba 14,4 cm,  $\varnothing$  dna 6,8 cm, deblj. stijenke 0,6 cm  
Lit.: Dimitrijević 1977–78: T. 9:10; Dimitrijević 1979c: T. XXX:2; Die

Neandertaler 1994: 125, kat. br. V 29; Tasić 1995: T. XXXI:4; Orion 2000: kat. br. 2.

**170.** inv. 20378, kv. 23–24, dub. 5,70  
Ulomak zaobljene zdjele ukrašene s obje strane. Tamnosive boje, uglačane površine. Ukrašen je izveden rovašenjem ispunjenim inkrustacijom.  
Dimenzije: deblj. stijenke 1 cm

**171.** inv. 5875

Ulomak zaobljene zdjele ukrašene s obje strane. Oker boje, presjek tamnosive boje, uglačane površine. Ukrašen je izveden rovašenjem ispunjenim inkrustacijom.  
Dimenzije: deblj. stijenke 1 cm  
Lit.: Hoffiller 1938: T.5:5a-b (napomena: na T.5:1a-b objavljen je ulomak koji pripada istoj posudi).

**172.** inv. 6192

Prstenasta noga. Tamnosive boje, djelomično uglačane površine.  
Dimenzije: vis. noge 3 cm,  $\varnothing$  noge 6,7 cm

**173.** inv. 5883

Prstenasta noga, blaga križnog oblika. Ukrašena rovašenjem, tamnosive, djelomično uglačane površine.  
Dimenzije: šir. dna 6,4 cm  
Lit.: Hoffiller 1938: T. 8:19.

**174.** inv. 5883

Ulomak križne noge. Smeđe boje, uglačane površine.  
Dimenzije: deblj. stijenke recipijenta 0,8 cm  
Lit.: Hoffiller 1938: T. 7:17.

**175.** inv. 20384

Križna noga. Ukrašena s obje strane dubokim urezivanjem djelomično ispunjenim inkrustacijom. Tamnosive boje, djelomično uglačane površine.  
Dimenzije: vis. noge 2,1 cm, šir. noge 6 cm, deblj. stijenke recipijenta 0,6 cm

**176.** inv. 6553

Ulomak posudice konična tijela i ravna dna. Unutarnja strana i dno ukraseni su urezivanjem. Tamnosive boje, djelomično uglačane površine.  
Dimenzije:  $\varnothing$  dna 2,4 cm, deblj. stijenke 0,5 cm  
Lit.: Hoffiller 1938: T. 8:20.

**177.** inv. 16931, kv. 15, dub. 2,90

Posuda četvrtasta, pravokutna oblika, ravnih stijenki. Vanjska

površina je oker, a unutarnja tamnosive boje; glatke, mat površine.  
Dimenzije: vis. 8,4 cm, otvor 20 x 15 cm, dno 19 x 14 cm, deblj. stijenke 0,8 cm  
Lit.: Die Neandertaler 1994: 124, kat. br. V 25.

**178.** inv. 7902

Posuda četvrtasta, pravokutna oblika i kosih stijenki. Smeđe boje, glatke, mat površine.  
Dimenzije: vis. 7,4 cm, otvor 22,8 x 18 cm, dno 14,4 x 11,4 cm, deblj. stijenke 0,6 cm

**179.** inv. 4678

Ulomak posude konična tijela s izduženom plastičnom aplikacijom. Smeđe boje, glatke, mat površine.  
Dimenzije: 10,1 x 9,5 cm, deblj. stijenke 0,8 cm

**180.** inv. 20387

Posuda konična oblika. Smeđe boje, glatke, mat površine.  
Dimenzije: vis. 4 cm,  $\varnothing$  ruba 9,5 cm,  $\varnothing$  dna 5,5 cm, deblj. stijenke 0,6 cm

**181.** inv. 6188

Posudica konična tijela s prihvatom uz rub. Tamnosive, djelomično uglačane površine.  
Dimenzije: vis. 2,7 cm,  $\varnothing$  ruba 5,2 cm,  $\varnothing$  dna 2,3 cm  
Lit.: Hoffiller 1938: T.1:3; Balen 1982: T.3:8.

**182.** inv. 16932, kv. 7, dub. 3,80

Ovalna uska posuda s unutarnjom pregradom po dužoj osi. Smeđe boje, slabo zaglađene, neravne površine.  
Dimenzije: vis. 3,8 cm, otvor 11,8 x 7 cm, dno 11,4 x 4 cm  
Lit.: Die Neandertaler 1994: 125, kat. br. V 31.

**183.** inv. 6194

Donji dio (ravno dno i bočne zaobljene stijenke) posude s dvjema čepastim drškama. Ukrašena rovašenjem, oker-smeđe boje, neravne i slabo zaglađene površine.  
Dimenzije: duž. 25,4 cm, šir. 17 cm, deblj. stijenki 0,9 cm  
Lit. Hoffiller 1938: T. 4:4.

**184.** inv. 6327 (sl. 36)

Zidna posuda u obliku krušne peći. Jedna ploha – dno ravno je, ukraseno urezanim linijama, a tijelo, tj. kupola zaobljeno je, s otvorom na užoj strani. Na bočnim su stranama dvije bradavičaste

- Marković 1994: T. 34:2; Tasić 1995: T. XXX:3.
- 162.** inv. 7856, q. 20, depth. 3,00  
A small vessel with a short, cylindrical neck, grey-yellow, partly polished surface. The lugs are placed at the vessel's shoulder. The vessel's body is decorated by grooved incision.  
Dimensions: ht. 5,2 cm, rim diameter 4 cm, base diameter 3,5 cm, wall width 0,3 cm  
Lit.: Die Neandertaler 1994: 124, cat. No. V 26.
- 163.** inv. 6196  
A hollow bell-shaped foot, decorated by grooved incision filled with encrustation. Dark grey, partly polished surface.  
Dimensions: ht. 5,6 cm, wall width 0,5 cm  
Lit.: Hoffiller 1938: T.7:10.
- 164.** inv. 6196  
A small rounded bowl placed on four stopper-like legs (two are preserved). Decorated by notching. Yellowish-ochre, partly polished surface.  
Dimensions: diameter 4,7 cm, wall width 0,35 cm  
Lit.: Hoffiller 1938: T.8:21.
- 165.** inv. 5873  
A bowl with accentuated shoulders and a rounded rim placed on four stopper-like legs (one is preserved). Decorated with an engraved zigzag line on the inner side below the rim, and on the outside the decoration at the broadest section and at the base is made by notching filled with encrustation. Grey, matte surface.  
Dimensions: rim diameter 13,8 cm, wall thickness 0,4 cm  
Lit.: Hoffiller 1938: T.7:5.
- 166.** inv. 6553  
A bowl with accentuated shoulders and a rounded rim placed on four stopper-like legs (one is preserved). Decorated with a line made by grooved incision on the inner side below the rim, and on the outside the decoration at the broadest section in the form of a band and at the base is made by notching filled with encrustation. Brown, matte surface.  
Dimensions: 6,7 x 7,4 cm, wall thickness 0,6 cm  
Lit.: Hoffiller 1938: T.7:7.
- 167.** inv. 6196  
A fragment of a stopper-like leg, dark grey, matte surface.  
Dimensions: wall width 0,5 cm  
168. inv. 6191  
A rounded bowl on a cross-shaped foot, ochre-brown, polished surface.  
Dimensions: ht. 6,3 cm rim diameter 13,7 cm, base width. 6,4 cm, wall width 0,7 cm  
Lit.: Hoffiller 1938: T.2:10.
- 169.** inv. 7862, q. A, depth. 2,00  
A conical, shallow bowl on a ring-shaped foot. The interior is decorated by notching. Ochre, polished surface.  
Dimensions: ht. 4 cm, rim diameter 14,4 cm, base diameter 6,8 cm, wall width 0,6 cm  
Lit.: Dimitrijević 1977–78: T. 9:10; Dimitrijević 1979c: T. XXX:2; Die Neandertaler 1994: 125, cat. No. V 29; Tasić 1995: T. XXXI:4; Orion 2000: cat. No. 2.
- 170.** inv. 20379, q. 23-24, depth. 5,70  
A fragment of a rounded bowl decorated on both sides. Dark grey, polished surface. The decoration is made by notching filled with encrustation. Dimensions: wall width 1 cm
- 171.** inv. 5875  
A fragment of a rounded bowl decorated on both sides. Ochre, the break is dark grey, polished surface. The decoration is made by notching filled with encrustation. Dimensions: wall width 1 cm  
Lit.: Hoffiller 1938: T.5:5a-b (note: in T.5:1a-b a fragment was published belonging to the same vessel).
- 172.** inv. 6192  
A ring-shaped foot, dark grey, partly polished surface.  
Dimensions: foot ht. 3 cm, foot diameter 6,7 cm
- 173.** inv. 5883  
A ring-shaped foot, gently cross-shaped, decorated by notching. Dark grey, partly polished surface.  
Dimensions: base width 6,4 cm  
Lit.: Hoffiller 1938: T.8:19.  
174. inv. 5883  
A fragment of a cross foot, brown, polished surface.  
Dimensions: container wall width 0,8 cm  
Lit.: Hoffiller 1938: T.7:17.
- 175.** inv. 20384  
A cross foot, decorated on both sides by deep incision, partly filled with encrustation. Dark grey, partly polished surface.  
Dimensions: foot ht. 2,1 cm, foot width 6 cm, container wall width 0,6 cm
- 176.** inv. 6553  
A fragment of a small conical vessel with a flat base. The interior and the base are decorated by incision. Dark grey, partly polished surface.  
Dimensions: base diameter 2,4 cm, wall width 0,5 cm  
Lit.: Hoffiller 1938: T.8:20.
- 177.** inv. 16931, q. 15, depth. 2,90  
A square, rectangular vessel with straight walls. The exterior is ochre, the interior dark grey, matte surface.  
Dimensions: ht. 8,4 cm, opening 20 x 15 cm, base 19 x 14 cm, wall width 0,8 cm  
Lit.: Die Neandertaler 1994: 124, cat. No. V 25.
- 178.** inv. 7902  
A square, rectangular vessel with a conical body. Brown, matte surface.  
Dimensions: ht. 7,4 cm, opening 22,8 x 18 cm, base 14,4 x 11,4 cm, wall width 0,6 cm  
179. inv. 4678  
A fragment of a vessel with a conical body and a elongated relief application. Brown, matte surface.  
Dimensions: 10,1 x 9,5 cm, wall width 0,8 cm
- 180.** inv. 20387  
A conical vessel, brown, matte surface.  
Dimensions: ht. 4 cm, rim diameter 9,5 cm, base diameter 5,5 cm, wall width 0,6 cm
- 181.** inv. 6188  
A small vessel with conical body and handle at the rim. Dark grey, partly polished surface.  
Dimensions: ht. 2,7 cm, rim diameter 5,2 cm, base diameter 2,3 cm  
Lit.: Hoffiller 1938: T.1:3, Balen 1982: T.3:8.
- 182.** 16933, q. 7, depth. 3,80  
An oval, narrow vessel with internal barrier on the longer axis. Brown, poorly polished, uneven surface.  
Dimensions: ht. 3,8 cm, opening 11,8 x 7 cm, base 11,4 x 4 cm  
Lit.: Die Neandertaler 1994: 125, cat. No. V 31.
- 183.** inv. 6194  
The lower part (flat base and lateral rounded walls) of a vessel

- aplikacije, a od otvora do dna po sredini proteže se rebrasta izbočina. Ukrašen na kupoli ukrašen je dubokim urezivanjem. Kupola je tamnosmeđe, a dno oker boje, djelomično uglačane površine. Dimenzije: vis. 4,5 cm, dno 7,6 x 6 cm  
Lit.: Hoffiller 1938: T. 4:3a–b.
- 185.** inv. 7882, kv. 33, dub. 4,40  
Ulomak dna i zaobljene stijenke zidne posude. Ukrašen je izveden rovašenjem ispunjenom inkrustacijom. Sive boje, djelomično uglačane površine. Dimenzije: deblj. stijenke 1–1,2 cm  
Lit.: Dimitrijević 1977–78: T. 9:1 (napomena: ulomak je okrenut okomito)
- 186.** inv. 20379, kv. 14, dub. 1,20  
Ulomak zaobljene stijenke zidne posude. Tamnosive boje, djelomično uglačane površine. Dimenzije: 4,7 x 5 cm, deblj. stijenke 0,85 cm
- 187.** inv. 7911, kv. B, dub. 1,20  
Keramički ljevkast predmet duga uska cilindričnoga grla. Tamnosive boje, glatke, mat površine. Dimenzije: vis. 12,8 cm,  $\emptyset$  lijevka 14,6 cm,  $\emptyset$  grla 3,6 cm, deblj. stijenke grla 1 cm
- 188.** inv. 7912, kv. 19, dub. 1,40  
Keramički ljevkast predmet nazupčanih rubova, duga uska cilindričnoga grla. Oker boje, glatke, mat površine. Dimenzije: vis. 11 cm,  $\emptyset$  lijevka 12 cm,  $\emptyset$  grla 3,2 cm, deblj. stijenke grla 1 cm
- 189.** inv. 4941  
Konični šuplji recipijent. Slabo zaglađene, neravne površine, oker-smeđe boje. Dimenzije:  $\emptyset$  lijevka 11 cm
- 190.** inv. 6193  
Konični šuplji recipijent. Slabo zaglađene, neravne površine; unutarnja strana je tamne, a vanjska oker boje. Dimenzije:  $\emptyset$  lijevka 13 m,  $\emptyset$  uskog grla 4,1 cm, deblj. stijenke grla 1,2 cm
- 191.** inv. 4941  
Dio uskoga, šupljega grla. Smeđe boje, slabo zaglađene, neravne površine. Dimenzije:  $\emptyset$  grla 3,3 cm, deblj. stijenke grla 0,7 cm
- 192.** inv. 6193  
Usko, šuplje grlo. Oker boje, slabo zaglađene, neravne površine. Dimenzije:  $\emptyset$  grla 3,5 cm, deblj. stijenke grla 0,7 cm
- 193.** inv. 6193  
Dio uskoga, šupljega grla. Sivo-oker boje, slabo zaglađene, neravne površine. Dimenzije:  $\emptyset$  grla 3,5 cm, deblj. stijenke grla 0,7 cm
- 194.** inv. 6197  
Posudica vrlo plitkoga recipijenta postavljena na dvije noge. Oker boje, glatke, mat površine. Dimenzije: vis. 3,7 cm,  $\emptyset$  ruba 7 cm
- 195.** inv. 7908, kv. 20, dub. 1,80  
Okrugli stolić na križnoj nozi. Gornja ploha ukrašena je ubodima. Tamnosive-oker boje, glatke, mat površine. Dimenzije: vis. 2 cm,  $\emptyset$  5,5 cm  
Lit.: Balen 1982: T. 3:7.
- 196.** inv. 7909, kv. 18, dub. 3,00  
Konična posudica na dvije noge. Ukrašena urezivanjem i ubodanjem., tamnosmeđe boje, glatke, mat površine. Dimenzije: vis. 2,7 cm,  $\emptyset$  5 cm  
Lit.: Balen 1982: T. 3:10; Die Neandertaler 1994: 126, kat. br. V 37.
- 197.** inv. 4674  
Dvodijelna posuda (dvije spojene posude s jednim otvorom). Bikoničnoga tijela, s ušicom na prijelomu te s trima rupicama na donjem dijelu i na vratu. Ukrašena je rovašenjem. Crvene boje, uglačane površine. Dimenzije: vis. 6,7 cm,  $\emptyset$  ruba 3,9 cm,  $\emptyset$  dna 3,8 cm, najveća širina 9,2 cm  
Lit.: Hoffiller 1938: T. 4:1a-c; Dimitrijević 1977–78: T. 9:8; Dimitrijević 1979c: T. XXX:4; Marković 1994: T. 34:3 Die Neandertaler 1994: 124, kat. br. V 24.
- 198.** inv. 6196  
Ulomak gornjega dijela kadionice ukrašene rovašenjem. Tamnosive boje, glatke, mat površine. Dimenzije: 10,2 x 5,9 cm, deblj. stijenke 0,7 cm
- 199.** inv. 6196  
Ulomak gornjega dijela kadionice ukrašene rovašenjem ispunjenim inkrustacijom. Sive boje, glatke, mat površine. Dimenzije: 8,5 x 3,1 cm, deblj. stijenke 0,5 cm
- 200.** inv. 7864, kv. 19, dub. 2,80, J 52 (sl. 38)  
Gornji dio kadionice ukrašene rovašenjem ispunjenim inkrustacijom. Tamnosive boje, glatke, mat površine. Dimenzije:  $\emptyset$  otvora 5,2 cm, najveća širina 11,6 cm, deblj. stijenke 0,6 cm
- 201.** inv. 7863, kv. 10A, dub. 3,50 (sl. 35)  
Posuda cilindrična vrata te trbuha raščlanjena na tri cjevasta, međusobno spojena dijela. Na ramenu posude nalaze se dvije male tunelaste ušice. Ukrašena je rovašenjem ispunjenim bijelom inkrustacijom. Oker boje, uglačane površine. Dimenzije: vis. 14,5 cm,  $\emptyset$  ruba 6,3 cm,  $\emptyset$  dna 5 cm  
Lit.: Dimitrijević 1977–78: T. 9:7; Dimitrijević 1979c: T. XXX:6; Vučedol 1988: kat. br. 48; Katalog AMZ 1993: kat. br. 11; Marković 1994: T. 34:5; Die Neandertaler 1994: 123, kat. br. V 20; Tasić 1995: T. XXXI:2; Muzeopis 1996: kat. br. 10.
- 202.** inv. 5870  
Posuda cilindrična vrata te trbuha raščlanjena na tri cjevasta, međusobno spojena dijela. Na ramenu posude nalaze se dvije male tunelaste ušice. Ukrašena je urezivanjem. Sive boje, glatke, mat površine. Djelomično je rekonstruirana. Dimenzije: vis. 9,5 cm,  $\emptyset$  ruba 3,5 cm,  $\emptyset$  dna 3 cm  
Lit.: Hoffiller 1938: 7:12; Die Neandertaler 1994: 124, kat. br. V 21.
- 203.** inv. 7865, kv.13, dub. 6,50  
Jedan cjevasti dio višedijelne posude, ukrašene brazdastim urezivanjem ispunjenim bijelom i mjestimice crvenom bojom. Tamnosive boje, uglačane površine. Dimenzije: vis. 11,5 cm
- 204.** inv. 7894, kv. 23, dub. 3,10  
Model čizme. Površina je prekrivena mrežom plitko urezanih linija, koje najvjerojatnije oponašaju površinu kože ili krzna. Rubovi oko potplata, pojačanje na peti, rist i sare naglašeni su tankom plastičnom trakom prelomljenom ubodima i urezima čime se željelo naznačiti spajanje, odnosno šivanje. Žuto-smeđe boje. Dimenzije: vis. 7,5 cm  
Lit.: Miličević 1984: T. V:1; Vučedol 1988: kat. br. 25.

- with two stopper-like handles. Decorated by notching, ochre-brown, uneven and poorly polished surface. Dimensions: length 25,4 cm, width 17 cm, wall thickness 0,9 cm. Lit. Hoffiller 1938: T.4:4.
- 184.** inv. 6327 (fig. 36)  
A wall-hung vessel, oven-shaped. One plane-base is flat, decorated with an engraved line, the body i.e. cupola is rounded with one opening at the narrower side. On the lateral sides two nipple-like decorations are relief applied. From the opening to the base a rib-like extrusion crosses the central section of the vessel. The decoration at the cupola is made by deep grooving. The cupola is dark brown, the base is ochre, partly polished surface. Dimensions: ht. 4,5 cm, base 7,6 x 6 cm. Lit.: Hoffiller 1938: T.4:3a-b.
- 185.** inv. 7882, q. 33, depth. 4,40  
A fragment of a wall-hung vessel rounded wall. The decoration is made by notching filled with encrustation. Grey, partly polished surface. Dimensions: wall width 1-1,2 cm. Lit.: Dimitrijević 1977-78: T.9:1 (note: the fragment is turned vertically)
- 186.** inv. 20379, q. 14, depth. 1,20  
A fragment of a wall-hung vessel rounded wall. Dark grey, partly polished surface. Dimensions: 4,7 x 5 cm, wall width 0,85 cm
- 187.** inv. 7911, q. B, depth. 1,20  
A funnel-like item (bellows throat) with a long, narrow cylindrical throat. Dark grey, matte surface. Dimensions: ht. 12,8 cm, funnel diameter 14,6 cm, throat diameter 3,6 cm, wall throat width 1 cm
- 188.** inv. 7912, q. 19, depth. 1,40  
A ceramic, funnel-like item with coggled rims, a long, narrow cylindrical throat. Ochre, matte surface. Dimensions: ht. 11 cm, funnel diameter 12 cm, throat diameter 3,2 cm, wall throat width 1 cm. 189. inv. 4941  
A conical, hollow recipient, poorly polished, uneven surface, ochre-brown. Dimensions: funnel diameter 11 m
- 190.** inv. 6193  
A conical, hollow container, poorly polished, uneven surface, the interior is dark and the exterior ochre. Dimensions: funnel diameter 13 cm, diameter of the narrow throat 4,1 cm, wall throat width 1,2 cm. 191. inv. 4941  
Part of a narrow, hollow neck, brown, poorly polished, uneven surface. Dimensions: throat diameter 3,3 cm, wall throat width 0,7 cm
- 192.** inv. 6193  
A narrow, hollow neck, ochre, poorly polished, uneven surface. Dimensions: throat diameter 3,5 cm, wall throat width 0,7 cm. 193. inv. 6193  
Part of a narrow, hollow neck, grey-ochre, poorly polished, uneven surface. Dimensions: throat diameter 3,5 cm, wall throat width 0,7 cm
- 194.** inv. 6197  
A small, shallow vessel placed on two legs. Ochre, matte surface. Dimensions: ht. 3,7 cm, rim diameter 7 cm
- 195.** inv. 7908, q. 20, depth. 1,80  
A small, round table on a cross-formed foot. The upper plane is decorated with stabbings. Dark grey, matte surface. Dimensions: ht. 2 cm, pr. 5,5 cm. Lit.: Balen 1982: T. 3:7.
- 196.** inv. 7909, q. 18, depth. 3,00  
A conical vessel placed on two legs, decorated by incision and stabbing. Dark brown, matte surface. Dimensions: ht. 2,7 cm, pr. 5 cm. Lit.: Balen 1982: T. 3:10.
- 197.** inv. 4674  
A double vessel (two connected vessels with one opening) with a biconical profile, a lug at the break and three small holes at the lower section and on the neck. Decorated by notching. Red, polished surface. Dimensions: ht. 6,7 cm, rim diameter 3,9 cm, base diameter 3,8 cm, largest width 9,2 cm. Lit.: Hoffiller 1938: T. 4:1a-c; Dimitrijević 1977-78: T. 9:8; Dimitrijević 1979c: T. XXX:4; Marković 1994: T. 34:3 Die Neandertaler 1994: 124, cat. No. V 24.
- 198.** inv. 6196  
A fragment of the lower section of a censer, decorated by notch-
- ing. Dark grey, matte surface. Dimensions: 10,2 x 5,9 cm, wall width 0,7 cm
- 199.** inv. 6196  
A fragment of the upper section of a censer, decorated by notching filled with encrustation. Grey, matte surface. Dimensions: 8,5 x 3,1 cm, wall width 0,5 cm
- 200.** inv. 7864, q. 19, depth. 2,80 (fig. 38)  
The upper section of a censer, decorated by notching filled with encrustation. Dark grey, matte surface. Dimensions: opening diameter 5,2 cm, largest width 11,6 cm, wall width 0,6 cm
- 201.** inv. 7863, q. 10A, depth. 3,50 (fig. 35)  
A vessel with a cylindrical neck and a belly divided into three mutually connected pipe-like parts. At the shoulder there are two small tunnel-shaped lugs. It is decorated by notching filled with white encrustation. Ochre, polished surface. Dimensions: ht. 14,5 cm, rim diameter 6,3 cm, base diameter 5 cm. Lit.: Dimitrijević 1977-78: T. 9:7; Dimitrijević 1979c: T. XXX:6; Vučedol 1988: cat. No. 48; Katalog AMZ1993: cat. No. 11; Marković 1994: T. 34:5; Die Neandertaler 1994: 123, cat. No. V 20; Tasić 1995: T. XXXI:2; Muzeopis 1996: cat. No. 10.
- 202.** inv. 5870  
A vessel with a cylindrical neck and a belly divided into three mutually connected pipe-like parts. At the shoulder there are two small tunnel-shaped lugs. It is decorated by incision. Grey, matte surface. Partly reconstructed. Dimensions: ht. 9,5 cm, rim diameter 3,5 cm, base diameter 3 cm. Lit.: Hoffiller 1938: 7:12; Die Neandertaler 1994: 124, cat. No. V 21.
- 203.** inv. 7865, q.13, depth. 6,50  
A pipe-shaped part of a vessel consisting of more parts. It is decorated by grooved incision, filled with white and sporadically with red. Dark grey, polished surface. Dimensions: ht. 11,5 cm
- 204.** inv. 7894, q. 23, depth. 3,10  
The boot surface is covered with a net of shallowly incised lines that

- 205.** inv. 7896, kv. 17, dub. 3,35  
Model visoke cipele. Oko gležnja ukrašena rovašenom trakom ispunjenom inkrustacijom. Tamnosive boje, glatke, mat površine. Dimenzije: vis. 3,1 cm  
Lit.: Milićević 1984: T. V:2; Vučedol 1988: kat. br. 26.
- 206.** inv. 7897, kv. 17, dub. 3,35  
Model visoke cipele. Oko gležnja ukrašena rovašenom trakom ispunjenom inkrustacijom. Tamnosive boje, glatke, mat površine. Dimenzije: vis. 3,6 cm  
Lit.: Milićević 1984: T. V:3; Vučedol 1988: kat. br. 26.
- 207.** inv. 20380, kv. 8, dub. 0,75  
Ulomak konsekrativnih rogova. Oker boje, glatke, mat površine. Dimenzije: 5,6 x 6,3 cm, deblj. 4,5 cm
- 208.** inv. 6198  
Keramička kuka okrugla presjeka, s jednom rupom i utisnutim žlijebom. Dimenzije: duž. 8,3 cm, šir. 3,2 cm
- 209.** inv. 18956  
Ulomak keramičke kuke ovalna presjeka, s dvjema rupama. Dimenzije: duž. 11 cm, šir. 5 cm  
Lit.: Vučedol 1988: kat. br. 15.
- 210.** inv. 6329  
Keramička kuka za vješanje. Pravokutna presjeka, s jednom rupom i utisnutim žlijebom iznad nje. Dimenzije: duž. 10,5 cm, šir. 2,5 cm  
Lit.: Vučedol 1988: kat. br. 15.  
211. inv. br. 6329  
Keramička kuka. Četvrtasta presjeka, s jednom rupom i utisnutim žlijebom. Dimenzije: duž. 8,8 cm, šir. 3 cm  
Lit.: Vučedol 1988: kat. br. 15.
- 212.** inv. 5891  
Ulomak keramičke kuke s rupom. Dimenzije: šir. 2,7 cm
- 213.** inv. 4520  
Oštećena keramička kuka. Ovalna presjeka, s jednom rupom i utisnutim žlijebom. Dimenzije: šir. 3,7 cm
- 214.** inv. 5891  
Ulomak keramičke kuke. Ovalna presjeka, s jednom rupom i žlijebom. Dimenzije: šir. 4,8 cm
- 215.** inv. 5881  
Ulomak keramičke kuke okrugla presjeka. Dimenzije: duž. 5,4 cm, šir. 3,4 cm
- 216.** inv. 6198  
Ulomak keramičke kuke. Ovalna presjeka i s jednom rupom. Dimenzije: duž. 10,3 cm, šir. 4 cm
- 217.** inv. 5891  
Oštećena keramička kuka. Ovalna presjeka, s jednom rupom i utisnutim žlijebom. Dimenzije: duž. 7 cm, šir. 3 cm
- 218.** inv. 7913, kv. 24, dub. 1,40  
Keramička žlica s kružnim recipientom i restauriranom drškom. Dimenzije: duž. 14,3 cm (originalni je dio dužine 9,5 cm)  
Lit.: Die Neandertaler 1994: 126, kat. br. V 32.
- 219.** inv. 6199  
Keramički kalem. Okrugla presjeka, smeđe boje. Dimenzije: duž. 2,5 cm
- 220.** inv. 6199  
Keramički kalem. Okrugla presjeka, tamnosive boje. Dimenzije: duž. 2,6 cm
- 221.** inv. 6199  
Oštećeni keramički kalem. Okrugla presjeka, tamnosmeđe boje. Dimenzije: duž. 4,9 cm
- 222.** inv. 6199  
Keramički kalem. Okrugla presjeka, oker boje. Dimenzije: duž. 5,2 cm
- 223.** inv. 5892  
Keramički uteg. Stožasta oblika, crvene boje. Dimenzije: duž. 5,2 cm
- 224.** inv. 20381, kv. 10, dub. 2,60  
Keramički uteg. Stožasta oblika, ukrašen ubodima, tamnosmeđe boje. Dimenzije: duž. 5,8 cm
- 225.** inv. 4940  
Okrugli keramički poklopac s ušicom u sredini te s dvjema perforacijama uz rub. Tamnosive boje, glatke, mat površine. Dimenzije:  $\varnothing$  11,7 cm, deblj. 1,3 – 1,5 cm
- 226.** inv. 7915, 7916, kv. 15, dub. 3,50 (sl. 39)  
Dvodijelni kalup za lijevanje listolikih bodeža. Kalupna šupljina utisnuta je na jednom dijelu, a drugi je dio zaravnjen. Dimenzije: duž. 21 cm, šir. 10,1 cm, deblj. 3,7 cm  
Lit.: Schmidt 1945: fig. 81A; Milojčić 1949: T. 39:1; Vinski 1961: T. 1:2; Dimitrijević 1977–78: T. 9:3; Dimitrijević 1979c: T. XLIII:1; Durman 1983: T. 4:2; Vučedol 1988: kat. br. 208; Katalog AMZ 1993: kat. br. 14a; Die Neandertaler 1994: 127, kat. br. V 45; Muzeopis 1996: kat. br. 8a; Simbol 2006: kat. br. 24.
- 227.** inv. 7917, kv. 15, dub. 3,50  
Polovica, odnosno kalupna šupljina dvodijelnoga kalupa za lijevanje listolikih bodeža. Rekonstruiran je. Dimenzije: duž. 24 cm, šir. 10,3 cm, deblj. 2 cm  
Lit.: Milojčić 1949: T. 39:2; Vinski 1961: T. 1:1; Dimitrijević 1977–78: T. 9:4; Dimitrijević 1979c: T. XLIII:2; Durman 1983: T. 4:3.
- 228.** inv. 7918 (2 kom.), kv. 15, dub. 3,50 (sl. 40)  
Dvodijelni kalup za lijevanje dljeteta. Kalupna šupljina za lijevanje utisnuta je na oba dijela. Dimenzije: duž. 15 cm, šir. 4 cm, deblj. 3 cm  
Lit.: Dimitrijević 1977–78: T. 9:2; Dimitrijević 1979c: T. XLIII: 3–4; Durman 1983, T. 4:4,5.; Vučedol 1988: kat. br. 209; Katalog AMZ 1993: kat. br. 14b; Die Neandertaler 1994: 127, kat. br. V 46; Muzeopis 1996: kat. br. 8b; Simbol 2006: kat. br. 25.
- 229.** inv. 19976 (sl. 43)  
Trijangularni plosnati bakreni bodež. Dimenzije: duž. 7,3 cm, šir. 2 cm  
Lit.: Vinski 1961, str. 5, sl. A (napomena: u bilješci 17 navodi se da je inventiran pod brojem 10679, međutim pod tim brojem u inv. knizi inventiran je drugi predmet)
- 230.** inv. 7924, kv. A, dub. 3,00  
Koštani vrh harpuna. Okrugla presjeka, s rupom. Dimenzije: duž. 9,5 cm  
Lit.: Vučedol 1988: kat. br. 8.
- 231.** inv. 7925, kv. 15, dub. 3,50  
Koštani vrh harpuna. Okrugla presjeka, s rupom. Dimenzije: duž. 8,3 cm  
Lit.: Vučedol 1988: kat. br. 8.
- 232.** inv. 6179  
Koštani vrh harpuna. Okrugla presjeka, s rupom, utisnutim žlijebom na vrhu i urezanom linijom. Dimenzije: duž. 8 cm  
Lit.: Vučedol 1988: kat. br. 8.

- most likely imitate the surface of fur or skin. The sole rim, the reinforcement at the heel are accentuated by a thin relief applied band with stabbings and incisions that symbolize connecting i.e. sewing. Yellow-brown.  
Dimensions: ht. 7,5 cm  
Lit.: Milićević 1984: T. V:1; Vučedol 1988: cat. No. 25.
- 205.** inv. 7896, q. 17, depth. 3,35  
A model of a high shoe, decorated with a notched band at the ankle filled with encrustation. Dark grey, matte surface.  
Dimensions: ht. 3,1 cm  
Lit.: Milićević 1984: T. V:2; Vučedol 1988: cat. No. 26.
- 206.** inv. 7897, q. 17, depth. 3,35  
A model of a high shoe, decorated with a notched band at the ankle filled with encrustation. Dark grey, matte surface.  
Dimensions: ht. 3,6 cm  
Lit.: Milićević 1984: T. V:3; Vučedol 1988: cat. No. 26.
- 207.** inv. 20380, q. 8, depth. 0,75  
A fragment of consecrated horns, ochre, matte surface.  
Dimensions: 5,6 x 6,3 cm, thickness. 4,5 cm
- 208.** inv. 6198  
A ceramic hook, oval break with a hole and an imprinted grooving. Dimensions: length 8,3 cm, width. 3,2 cm
- 209.** inv. 18956  
A fragment of a ceramic hook with an oval break and two holes. Dimensions: length 11 cm, width. 5 cm  
Lit.: Vučedol 1988: cat. No. 15.
- 210.** inv. 6329  
A suspension ceramic hook, rectangular break, with a hole and imprinted grooving above the hole.  
Dimensions: length 10,5 cm, width. 2,5 cm  
Lit.: Vučedol 1988: cat. No. 15.
- 211.** inv. 6329  
A ceramic hook with rectangular break, a hole and imprinted grooving.  
Dimensions: length 8,8 cm, width. 3 cm  
Lit.: Vučedol 1988: cat. No. 15.
- 212.** inv. 5891  
A fragment of a ceramic hook with a hole.  
Dimensions: width 2,7 cm
- 213.** inv. 4520  
A damaged ceramic hook with an oval break, a hole and imprinted grooving. Dimensions: width 3,7 cm
- 214.** inv. 5891  
A fragment of a ceramic hook with an oval break, a hole and a grooving.  
Dimensions: width. 4,8 cm
- 215.** inv. 5881  
A fragment of a ceramic hook with an oval break.  
Dimensions: length 5,4 cm, width 3,4 cm
- 216.** inv. 6198  
A fragment of a ceramic hook with an oval break and a hole.  
Dimensions: length 10,3 cm, width. 4 cm
- 217.** inv. 5891  
A damaged ceramic hook, oval break with a hole imprinted in the grooving.  
Dimensions: length 7 cm, width. 3 cm
- 218.** inv. 7913, q. 24, depth. 1,40  
A ceramic spoon with a circular container and a restored handle  
Dimensions: length 14,3 cm (the original is 9,5 cm long)  
Lit.: Die Neandertaler 1994: 126, cat. No. V 32.
- 219.** inv. 6199  
A ceramic spool, oval break, brown.  
Dimensions: length 2,5 cm  
220. inv. 6199  
A ceramic spool, oval break, dark grey.  
Dimensions: length 2,6 cm
- 221.** inv. 6199  
A damaged, ceramic spool, oval break, dark brown  
Dimensions: length 4,9 cm
- 222.** inv. 6199  
A ceramic spool, oval break, ochre.  
Dimensions: length 5,2 cm
- 223.** inv. 5892  
A red, conical, ceramic weight.  
Dimensions: length 5,2 cm
- 224.** inv. 20381, q. 10, depth. 2,60  
A conical, ceramic weight decorated with dark brown stabbings.  
Dimensions: length 5,8 cm
- 225.** inv. 4940  
A circular ceramic lid with a lug in the middle and two perforations at the rim. Dark grey, matte surface.  
Dimensions: diameter 11,7 cm, thickness 1,3 – 1,5 cm
- 226.** inv. 7915, 7916, q. 15, depth. 3,50 (fig. 39)  
A bipartite mould for casting leaf-like daggers. The mould hollow is imprinted on one part, whereas the other part is evened  
Dimensions: length 21 cm, width. 10,1 cm, thickness. 3,7 cm  
Lit.: Schmidt 1945: fig. 81A; Milošević 1949: T. 39:1; Vinski 1961: T. 1:2; Dimitrijević 1977–78: T. 9:3; Dimitrijević 1979c: T. XLIII:1; Durman 1983: T. 4:2; Vučedol 1988: cat. No. 208; Katalog AMZ1993: cat. No. 14a; Die Neandertaler 1994: 127, cat. No. V 45; Muzeopis 1996: cat. No. 8a; Simbol boga 2006: cat. No. 24.
- 227.** inv. 7917, q. 15, depth. 3,50  
One half i.e. the mould hollow of the bipartite mould for casting leaf-like daggers. It is reconstructed.  
Dimensions: length 24 cm, width. 10,3 cm, thickness 2 cm  
Lit.: Milošević 1949: T. 39:2; Vinski 1961: T. 1:1; Dimitrijević 1977–78: T. 9:4; Dimitrijević 1979c: T. XLIII:2; Durman 1983: T. 4:3.
- 228.** inv. 7918 (2 pieces.), q. 15, depth. 3,50 (fig. 40)  
A bipartite mould for casting chisels. The mould's casting hollow is imprinted on both parts.  
Dimensions: length 15 cm, width. 4 cm, thickness 3 cm  
Lit.: Dimitrijević 1977–78: T. 9:2; Dimitrijević 1979c: T. XLIII: 3–4; Durman 1983, T. 4:4,5.; Vučedol 1988: cat. No. 209; Katalog AMZ1993: cat. No. 14b; Die Neandertaler 1994: 127, cat. No. V 46; Muzeopis 1996: cat. No. 8b; Simbol 2006: cat. No. 25.
- 229.** inv. 19976 (fig. 43)  
A triangular, flat copper dagger.  
Dimensions: length 7,3 cm, width. 2 cm  
Lit.: Vinski 1961, page 5, letter A (note: in the footnote 17 the inventory number 10679 is given, however another item is registered under this number)
- 230.** inv. 7924, q. A, depth. 3,00  
A bone harpoon top, oval break with a hole.  
Dimensions: length 9,5 cm  
Lit.: Vučedol 1988: cat. No. 8.



- 233.** inv. 6181  
Ulomak koštanoga vrha harpuna. Okrugla presjeka, s rupom. Dimenzije: duž. 6,8 cm
- 234.** inv. 6180  
Koštani vrh harpuna. Okrugla presjeka, s dvjema rupama. Dimenzije: duž. 7,6 cm  
Lit.: Vučedol 1988: kat. br. 8.
- 235.** inv. 6179  
Koštani vrh harpuna. Okrugla presjeka, s rupom. Dimenzije: duž. 8 cm  
Lit.: Vučedol 1988: kat. br. 8.
- 236.** inv. 7926, kv. 19, dub. 3,60 (sl. 44)  
Koštana sjekira s rupom za nasad. Dimenzije: duž. 11,5 cm, šir. 3,8 cm, deblj. 4,7 cm
- 237.** inv. 5897  
Motika od jelenjega paroška s rupom za nasad. Dimenzije: duž. 7,8 cm, šir. 7,6 cm
- 238.** inv. 5897  
Motika od jelenjega paroška s rupom za nasad. Dimenzije: duž. 13,2 cm, šir. 8,6 cm
- 239.** inv. 5897  
Motika od jelenjega paroška s rupom za nasad. Dimenzije: duž. 11 cm, šir. 7,3 cm
- 240.** inv. 6176  
Motika od jelenjega paroška s rupom za nasad. Dimenzije: duž. 12 cm, šir. 6,3 cm
- 241.** inv. 6176  
Motika od jelenjega paroška s rupom za nasad. Dimenzije: duž. 15,5 cm, šir. 7,1 cm
- 242.** inv. 6176  
Motika od jelenjega paroška s rupom za nasad. Dimenzije: duž. 13,7 cm, šir. 6 cm
- 243.** inv. 6176  
Motika od jelenjega paroška s rupom za nasad. Dimenzije: duž. 14,7 cm, šir. 6,3 cm
- 244.** inv. 6177  
Uomak motike od jelenjega paroška s rupom za nasad. Dimenzije: duž. 14 cm, šir. 7 cm
- 245.** inv. 7919, kv. 12, dub. 2,50  
Kost – lopatica sa zupcima na jednoj strani. Dimenzije: duž. 23,2 cm  
Lit.: Vučedol 1988: kat. br. 7.
- 246.** inv. 6178  
Kost jelenjega paroška s tragovima mesarenja. Dimenzije: duž. 16 cm
- 247.** inv. 6552  
Zaglađena kost, raskoljena i polukružno obrađena – gladilica ili spatula. Dimenzije: duž. 7,5 cm
- 248.** inv. 5019  
Zaglađena kost koja se blago sužava pri kraju. Dimenzije: duž. 9,7 cm
- 249.** inv. 6551  
Koštano šilo. Grubo obrađen predmet s dijelom zgloba, očuvanim na gornjoj strani. Dimenzije: duž. 8,4 cm
- 250.** inv. 6178  
Obrađena kost sa zarezima pri vrhu. Dimenzije: duž. 10,8 cm
- 251.** inv. 5898  
Alatka od jelenjega paroška s tragovima mesarenja. Dimenzije: duž. 13,2 cm
- 252.** inv. 5898  
Alatka od jelenjega paroška. Dimenzije: duž. 12,8 cm
- 253.** inv. 6182  
Koštano šilo. Grubo obrađen predmet s dijelom zgloba, očuvanim na gornjoj strani. Dimenzije: duž. 11 cm
- 254.** inv. 7920, kv. 12, dub. 2,50  
Obrađena, zašiljena kost. Dimenzije: duž. 12,7 cm
- 255.** inv. 7921, kv. 14, dub. 2,10  
Obrađena, zašiljena kost. Dimenzije: duž. 12,7 cm
- 256.** inv. 7923, kv. 15, dub. 2,00  
Obrađena, zašiljena kost s dijelom zgloba na gornjoj strani. Dimenzije: duž. 21 cm
- 257.** inv. 7922, kv. 8, dub. 3,80  
Obrađena, zašiljena kost s dijelom zgloba na gornjoj strani. Dimenzije: duž. 19,5 cm
- 258.** inv. 4515  
Kost raskoljena po širini – gladilica ili spatula. Jedna je polovica obrađena i zaglađena. Donji dio je polukružno izglađen. Dimenzije: duž. 9,7 cm, šir. 2,5 cm
- 259.** inv. 4516  
Obrađena i zaglađena kost s perforacijama. Dimenzije: duž. 9 cm, šir. 2,1 cm
- 260.** inv. 7934, kv. 20, dub. 5,40  
Kamena perla. Okrugla, izdužena oblika. Dimenzije: 3,3 x 1,9 cm, ø 1,5 cm
- 261.** inv. 7933, kv. 20, dub. 5,40  
Kamena perla. Okrugla, plosnata oblika. Dimenzije: 1,9 x 1 cm, ø 2 cm
- 262.** inv. 6550  
Ulomak kamene sjekire s rupom za nasad, s naglašenim središnjim dijelom i zaobljenom oštricom. Dimenzije: duž. 5,4 cm, šir. 3,3 cm, deblj. 3,5 cm
- 263.** inv. 7928, kv. 14, dub. 2,50  
Ulomak kamene sjekire s rupom za nasad. Sačuvan je dio s oštricom. Dimenzije: duž. 10,2 cm, šir. 4,2 cm, deblj. 4,5 cm
- 264.** inv. 5861  
Ulomak sjekire – čekića s rupom za nasad. Dimenzije: duž. 6,2 cm, šir. 3,8 cm, duž. 3,9 cm
- 265.** inv. 5016  
Ulomak sjekire lepezasto proširene oštrice s rupom za nasad. Dimenzije: duž. 15,1 cm, šir. 4,4 cm, deblj. 3,4 cm
- 266.** inv. 5745  
Bat od glačana kamena. Izdužena oblika, s jednom zaobljenom stranom i vidljivim tragovima upotrebe. Dimenzije: duž. 10,4 cm, šir. 5,5 cm
- 267.** inv. 7927, kv. 14, dub. 3,90  
Ulomak kamene sjekire s rupom za nasad. Dimenzije: duž. 9,7 cm, šir. 7,2 cm, deblj. 6 cm
- 268.** inv. 5863  
Ulomak kamenoga brusa s rupom za ovjes. Dimenzije: duž. 7 cm, šir. 3,7 cm, deblj. 1,2 cm
- 269.** inv. 4514  
Alatka od pješčenjaka – rastirač. Četvrtasta oblika, blago zaobljenih rubova i vidljivim tragovima upotrebe na svim stranama. Dimenzije: 5,3 x 5,2 cm
- 270.** inv. 6173  
Alatka od pješčenjaka blago zaobljenih rubova – rastirač.

- 231.** inv. 7925, q. 15, depth. 3,50  
A bone harpoon top, oval break with a hole.  
Dimensions: length 8,3 cm  
Lit.: Vučedol 1988: cat. No. 8.
- 232.** inv. 6179  
A bone harpoon top, oval break with a hole, imprinted grooving at the top and an incised line.  
Dimensions: length 8 cm  
Lit.: Vučedol 1988: cat. No. 8.
- 233.** inv. 6181  
A fragment of a bone harpoon top, oval break with a hole  
Dimensions: length 6,8 cm
- 234.** inv. 6180  
A bone harpoon top, oval break with two holes.  
Dimensions: length 7,6 cm  
Lit.: Vučedol 1988: cat. No. 8.
- 235.** inv. 6179  
A bone harpoon top, oval break with a hole.  
Dimensions: length 8 cm  
Lit.: Vučedol 1988: cat. No. 8.
- 236.** inv. 7926, q. 19, depth. 3,60 (fig. 44)  
A bone axe with a mace hole.  
Dimensions: length 11,5 cm, width. 3,8 cm, thickness. 4,7 cm
- 237.** inv. 5897  
A hoe, antler, with a mace hole.  
Dimensions: length 7,8 cm, width. 7,6 cm
- 238.** inv. 5897  
A hoe, antler, with a mace hole.  
Dimensions: length 13,2 cm, width. 8,6 cm
- 239.** inv. 5897  
A hoe with mace hole, antler  
Dimensions: length 11 cm, width. 7,3 cm
- 240.** inv. 6176  
A hoe, antler, with a mace hole.  
Dimensions: length 12 cm, width. 6,3 cm
- 241.** inv. 6176  
A hoe, antler, with a mace hole.  
Dimensions: length 15,5 cm, width. 7,1 cm
- 242.** inv. 6176  
A hoe, antler, with a mace hole.  
Dimensions: length 13,7 cm, width. 6 cm
- 243.** inv. 6176  
A hoe, antler, with a mace hole.  
Dimensions: length 14,7 cm, width. 6,3 cm
- 244.** inv. 6177  
A fragment of a hoe, antler, with a mace hole.  
Dimensions: length 14 cm, width. 7 cm
- 245.** inv. 7919, q. 12, depth. 2,50  
Bone – scoop with cogs on one side  
Dimensions: length 23,2 cm  
Lit.: Vučedol 1988: cat. No. 7.
- 246.** inv. 6178  
Antler bone with signs of butchery  
Dimensions: length 16 cm
- 247.** inv. 6552  
Polished bone, split and semi circularly treated – spatula.  
Dimensions: length 7,5 cm  
248. inv. 5019  
A mostly polished bone with a gentle narrowing at the end  
Dimensions: length 9,7 cm
- 249.** inv. 6551  
A bone awl, a coarsely treated item with a joint part preserved at the upper section.  
Dimensions: length 8,4 cm
- 250.** inv. 6178  
A treated bone with commas at the top.  
Dimensions: length 10,8 cm
- 251.** inv. 5898  
A tool, antler, with signs of butchery.  
Dimensions: length 13,2 cm
- 252.** inv. 5898  
A tool, antler  
Dimensions: length 12,8 cm
- 253.** inv. 6182  
A bone awl, a coarsely treated item with a joint part preserved at the upper section.  
Dimensions: length 11 cm
- 254.** inv. 7920, q. 12, depth. 2,50  
A treated, pointed bone.  
Dimensions: length 12,7 cm
- 255.** inv. 7921, q. 14, depth. 2,10  
A treated, pointed bone.  
Dimensions: length 12,7 cm
- 256.** inv. 7923, q. 15, depth. 2,00  
A treated, pointed bone with part of the joint at the upper side  
Dimensions: length 21 cm
- 257.** inv. 7922, q. 8, depth. 3,80  
A treated, pointed bone with part of the joint at the upper side  
Dimensions: length 19,5 cm
- 258.** inv. 4515  
A bone split along the width, one half is treated and polished. The lower section is semi circularly polished – spatula.  
Dimensions: length 9,7 cm, width. 2,5 cm
- 259.** inv. 4516  
A treated and mostly polished bone with holes.  
Dimensions: length 9 cm, width. 2,1 cm
- 260.** inv. 7934, q. 20, depth. 5,40  
A stone pearl, circular break, elongated shape.  
Dimensions: 3,3 x 1,9 cm, pr. 1,5 cm
- 261.** inv. 7933, q. 20, depth. 5,40  
A circular stone pearl with a flat shape.  
Dimensions: 1,9 x 1 cm, pr. 2 cm
- 262.** inv. 6550  
A fragment of a stone axe with shaft hole with accentuated central section and a rounded cutting edge.  
Dimensions: length 5,4 cm, width. 3,3 cm, thickness 3,5 cm
- 263.** inv. 7928, q. 14, depth. 2,50  
A fragment of a stone axe with shaft hole. The section with the blade is preserved.  
Dimensions: length 10,2 cm, width. 4,2 cm, thickness 4,5 cm
- 264.** inv. 5861  
A fragment of an axe-hammer with a shaft hole.  
Dimensions: length 6,2 cm, width. 3,8 cm, length 3,9 cm
- 265.** inv. 5016  
A fragment of an axe with a fan-like widening cutting edge and a shaft hole.  
Dimensions: length 15,1 cm, width. 4,4 cm, thickness 3,4 cm
- 266.** inv. 5745  
A hammer from polished stone, elongated with one rounded side and visible signs of usage.  
Dimensions: length 10,4 cm, width. 5,5 cm
- 267.** inv. 7927, q. 14, depth. 3,90  
A fragment of a stone axe with shaft hole.  
Dimensions: length 9,7 cm, width. 7,2 cm, thickness 6 cm
- 268.** inv. 5863  
A fragment of a whetstone with a suspension hole.  
Dimensions: length 7 cm, width. 3,7 cm, thickness 1,2 cm

- Dimenzije: 5,9 x 6 cm,  
deblj. 3,7 cm
- 271.** inv. 4513  
Jezgra za odbojke. Rožnjak crvene boje.  
Dimenzije: 3,3 x 2,3 cm
- 272.** inv. 5862  
Jednoplatformna jezgra za sječiva s okorinom od pješčenjaka.  
Dimenzije: duž. 4,6 cm
- 273.** inv. 5862  
Kombinirana jezgra. Rožnjak tamnosive boje.  
Dimenzije: duž. 4,3 cm
- 274.** inv. 5862  
Odbojak s okorinom. Rožnjak tamnosive boje.  
Dimenzije: duž. 6 cm
- 275.** inv. 6170  
Alatka rombična presjeka. Jedan rub alatke bifacijalno je obrađen. Rožnjak tamnosive boje.  
Dimenzije: duž. 3 cm
- 276.** inv. 5859  
Alatka na sječivu, rub jako obrađen – kao pila. Rožnjak sive boje.  
Dimenzije: duž. 3,3 cm
- 277.** inv. 5858  
Grebalo na sječivu. Rožnjak tamnosive boje.  
Dimenzije: duž. 4,3 cm
- 278.** inv. 5857  
Ulomak sječiva. Rožnjak crvene boje.  
Dimenzije: duž. 2,3 cm
- 279.** inv. 5857  
Ulomak sječiva. Rožnjak sive boje.  
Dimenzije: duž. 4,6 cm
- 280.** inv. 5857  
Grebalo na sječivu. Rožnjak tamnosive boje.  
Dimenzije: duž. 4 cm
- 281.** inv. 5857  
Ulomak sječiva od pješčenjaka.  
Dimenzije: duž. 4 cm
- 282.** inv. 5857  
Grebalo. Rožnjak crvene boje.  
Dimenzije: duž. 1,9 cm
- 283.** inv. 20385  
Grebalo. Rožnjak sive boje.  
Dimenzije: duž. 2 cm
- 284.** inv. 20385  
Grebalo. Rožnjak svijetlosive boje.  
Dimenzije: duž. 2,1 cm
- 285.** inv. 20385  
Grebalo. Rožnjak sive boje.  
Dimenzije: duž. 2,7 cm
- 286.** inv. 20385  
Grebalo, rožnjak tamnosive boje.  
Dimenzije: duž. 2,7 cm
- 287.** inv. 20386  
Dubilo. Rožnjak tamnosive boje.  
Dimenzije: duž. 2,3 cm
- 288.** inv. 20386  
Svrđlo. Rožnjak tamnosive boje.  
Dimenzije: duž. 2,4 cm
- 289.** inv. 20386  
Obrađeni komadić. Rožnjak svijetlosmeđe boje.  
Dimenzije: duž. 1,8 cm
- 290.** inv. 7929, kv. 9, dub. 4,30  
Sječivo od pješčenjaka.  
Dimenzije: duž. 5,7 cm
- 291.** inv. 7930, kv. 9, dub. 4,30  
Sječivo. Rožnjak žučkastosmeđe boje.  
Dimenzije: duž. 3,9 cm
- 292.** inv. 6169  
Sječivo s vidljivim sjajem na rubu. Rožnjak sive boje.  
Dimenzije: duž. 3,8 cm
- 293.** inv. 6169  
Sječivo. Rožnjak crvenosmeđe boje.  
Dimenzije: duž. 4,1 cm
- 294.** inv. 6169  
Sječivo. Rožnjak tamnosmeđe boje.  
Dimenzije: duž. 5,4 cm
- 295.** inv. 6169  
Sječivo s vidljivim sjajem na rubovima. Rožnjak tamnosmeđe boje.  
Dimenzije: duž. 5,4 cm
- 296.** inv. 6169  
Krijestasto sječivo. Rožnjak sive boje.  
Dimenzije: duž. 5,7 cm
- 297.** inv. 6202  
Okrugli keramički predmet sa središnjim cjevastim produžetkom otvora. Slabo zaglađene, neravne površine, oker-smeđe boje.  
Dimenzije:  $\varnothing$  6,9 cm
- 298.** inv. 6202  
Okrugli keramički predmet sa središnjim cjevastim produžetkom otvora. Slabo zaglađene, neravne površine, oker-smeđe boje.  
Dimenzije:  $\varnothing$  4,5 cm
- 299.** inv. 6202  
Okrugli keramički predmet sa središnjim cjevastim produžetkom otvora. Slabo zaglađene, neravne površine, oker-smeđe boje.  
Dimenzije:  $\varnothing$  3,7 cm
- 300.** inv. 6202  
Okrugli keramički predmet sa središnjim cjevastim produžetkom otvora. Slabo zaglađene, neravne površine, oker-smeđe boje.  
Dimenzije:  $\varnothing$  3,9 cm
- 301.** inv. 6202  
Okrugli keramički predmet sa središnjim cjevastim produžetkom otvora. Slabo zaglađene, neravne površine, oker-smeđe boje.  
Dimenzije:  $\varnothing$  3,6 cm

- 269.** inv. 4514  
A sandstone tool – hammer stone– rectangular, gently rounded edges with visible signs of usage on all sides.  
Dimensions: 5,3 x 5,2 cm
- 270.** inv. 6173  
A sandstone tool with gently rounded edges – hammer stone.  
Dimensions: 5,9 x 6 cm, thickness 3,7 cm
- 271.** inv. 4513  
A flake core, chert, red.  
Dimensions: 3,3 x 2,3 cm
- 272.** inv. 5862  
An one-platform blade core with a sandstone crust  
Dimensions: length 4,6 cm
- 273.** inv. 5862  
A combined core, chert, dark grey.  
Dimensions: length 4,3 cm
- 274.** inv. 5862  
A flake with crust, chert, dark grey.  
Dimensions: length 6 cm
- 275.** inv. 6170  
A tool with a rhombus break. One tool edge is shaped bifacially, chert, dark grey.  
Dimensions: length 3 cm
- 276.** inv. 5859  
A tool on a blade, the edge is shaped like a saw, chert, grey.  
Dimensions: length 3,3 cm
- 277.** inv. 5858  
An endscraper on a blade, chert, dark grey.  
Dimensions: length 4,3 cm
- 278.** inv. 5857  
A fragment of a blade, chert, red.  
Dimensions: length 2,3 cm
- 279.** inv. 5857  
A fragment of a blade, chert, grey.  
Dimensions: length 4,6 cm
- 280.** inv. 5857  
An endscraper on a blade, chert dark grey.  
Dimensions: length 4 cm
- 281.** inv. 5857  
A fragment of a blade, sandstone.  
Dimensions: length 4 cm
- 282.** inv. 5857  
An endscraper, chert, red.  
Dimensions: length 1,9 cm
- 283.** inv. 20385  
An endscraper, chert, grey.  
Dimensions: length 2 cm
- 284.** inv. 20385  
An endscraper, chert, light grey.  
Dimensions: length 2,1 cm
- 285.** inv. 20385  
An endscraper, chert, grey.  
Dimensions: length 2,7 cm
- 286.** inv. 20385  
An endscraper, chert, dark grey.  
Dimensions: length 2,7 cm
- 287.** inv. 20386  
A burin, chert, dark grey.  
Dimensions: length 2,3 cm
- 288.** inv. 20386  
A borer, chert, dark grey  
Dimensions: length 2,4 cm
- 289.** inv. 20386  
A retouched piece, chert, light brown. Dimensions: length 1,8 cm
- 290.** inv. 7929, q. 9, depth. 4,30A  
blade, sandstone.  
Dimensions: length 5,7 cm
- 291.** inv. 7930, q. 9, depth. 4,30  
A blade, yellowish-brown.  
Dimensions: length 3,9 cm
- 292.** inv. 6169  
A blade with visible edge gloss, chert, grey.  
Dimensions: length 3,8 cm
- 293.** inv. 6169  
A blade, chert, red-brown.  
Dimensions: length 4,1 cm
- 294.** inv. 6169  
A blade, chert, dark brown  
Dimensions: length 5,4 cm
- 295.** inv. 6169  
A dark brown blade with visible edge gloss, chert.  
Dimensions: length 5,4 cm
- 296.** inv. 6169  
A grey blade, crest-shaped, chert.  
Dimensions: length 5,7 cm
- 297.** inv. 6202  
Round ceramic item with a central, pipe-shaped extension of the opening. Poorly polished, uneven surface, ochre-brown.  
Dimensions: diameter 6,9 cm
- 298.** inv. 6202  
Round ceramic item with a central, pipe-shaped extension of the opening. Poorly polished, uneven surface, ochre-brown.  
Dimensions: diameter 4,5 cm
- 299.** inv. 6202  
Round ceramic item with a central, pipe-shaped extension of the opening. Poorly polished, uneven surface, ochre-brown.  
Dimensions: diameter 3,7 cm
- 300.** inv. 6202  
Round ceramic item with a central, pipe-shaped extension of the opening. Poorly polished, uneven surface, ochre-brown.  
Dimensions: diameter 3,9 cm
- 301.** inv. 6202  
Round ceramic item with a central, pipe-shaped extension of the opening. Poorly polished, uneven surface, ochre-brown.  
Dimensions: diameter 3,6 cm

## POPIS LITERATURE | BIBLIOGRAPHY

- Antonović 2003:** Dragana Antonović, *Neolitska industrija glačanog kamena u Srbiji*, Posebna izdanja 37, Arheološki institut, Beograd, 2003.
- Arandelović-Garašanin 1954:** Draga Arandelović-Garašanin, *Starčevačka kultura*, Ljubljana, 1954.
- Baden Culture 2004:** *Everyday life and spirituality at the end of the Copper Age, 5000 years old remains of the Baden Culture in Budapest*, katalog izložbe, ed. Anna Endrödi, Budapest, 2004.
- Balen 2002a:** Jacqueline Balen, Die Kostolac-Kultur in Kroatien, *Thraco-Dacica*, XXIII, 1–2, Bucuresti, 2002, 153–170.
- Balen 2002b:** Jacqueline Balen, Topografija nalazišta kostolačke kulture u sjevernoj Hrvatskoj, *Vjesnik Arheološkog muzeja u Zagrebu*, 3.s., XXXV, 2002, 35–52.
- Balen 2004:** Jacqueline Balen, Izvještaj s četvrte sezone sustavnog arheološkog iskopavanja tela Vučedol, *Obavijesti Hrvatskog arheološkog društva*, XXXVI/3, 2004, 63–67.
- Balen-Letunić 1981:** Dubravka Balen-Letunić, Kameno oružje i oruđe s područja Hrvatskog zagorja – zbirka Pečornik, *Godišnjak gradskog muzeja*, 6, Varaždin, 1981, 5–16.
- Balen-Letunić 1982:** Dubravka Balen-Letunić, Prehistorijske minijature posude-igračke iz Arheološkog muzeja u Zagrebu, *Vjesnik Arheološkog muzeja u Zagrebu*, 3.s., XV, 1982, 69–96.
- Banner 1956:** János Banner, *Die Pécelér Kultur*, *Archaeologia Hungarica* XXXV, Budapest, 1956.
- Barna 2001:** Judit P. Barna, Late Lengyel finds in Balatonmagyaród – Kápolnapuszta, u: *Sites and stones: Lengyel Culture in Western Hungary and beyond*, Veszprém, 2001, 61–69.
- Bondar 1995:** Maria Bondar, Early Bronze Age settlement patterns in South-West Transdanubia, *Antaeus*, 22, Budapest, 1995, 197–268.
- Bosendorfer 1942:** Josip Bosendorfer, Osijek i okolica u predhistorijskim eonima, *Osječki zbornik*, 1942, 5–22.
- Celestin 1897:** Vjekoslav Celestin, Neolitska naseobina kod Osijeka, *Vjesnik hrvatskog arheološkog društva*, n.s., II (1896–1897), 1897, 104–109.
- Childe 1929:** Gordon V. Childe, *The Danube in Prehistory*, Oxford 1929.
- Čečuk & Radić 2005:** Božidar Čečuk & Dinko Radić, *Vela Spila – Višeslojno pretpovijesno nalazište – Vela Luka, otok Korčula*, Vela Luka, 2005.
- Dimitrijević 1956:** Stojan Dimitrijević, Prilog daljem upoznavanju vučedolske kulture, *Opuscula Archaeologica*, I, Zagreb, 1956, 5–55.
- Dimitrijević 1962:** Stojan Dimitrijević, Prilog stupnjevanju badenske kulture u sjevernoj Hrvatskoj, *Arheološki radovi i rasprave*, II, Zagreb, 1962, 239–261.
- Dimitrijević 1966:** Stojan Dimitrijević, *Arheološka iskopavanja na području vinkovačkog muzeja, rezultati 1957.–1965.*, Vinkovci, 1966.
- Dimitrijević 1968:** Stojan Dimitrijević, *Sopotsko-lendelska kultura*, Zagreb, 1968.
- Dimitrijević 1969a:** Stojan Dimitrijević, *Starčevačka kultura u slavonsko-srijemskom prostoru i problem prijelaza ranog u srednji neolit u srpskom i hrvatskom Podunavlju*, Vukovar, 1969.
- Dimitrijević 1969b:** Stojan Dimitrijević, Das Neolithikum in Syrmien, Slawonien und Nordwestkroatien, *Archaeologia jugoslavica*, X, Beograd, 1969, 39–76.
- Dimitrijević 1971:** Stojan Dimitrijević, Zu einigen fragen des spätneolithikums und frühneolithikums in Nordjugoslawien, *Actes du XIIIe congres international des sciences prehistoriques et protohistoriques I*, Beograd, 1971, 141–172.
- Dimitrijević 1974:** Stojan Dimitrijević, Problem stupnjevanja starčevačke kulture s posebnim obzirom na doprinos južnopanonskih nalazišta rešavanju ovih problema, *Materijali*, X, Beograd, 1974, 59–122.
- Dimitrijević 1977–78:** Stojan Dimitrijević, Zur frage der Genese und der Gliederung der Vučedoler Kultur in dem Zwischenstromlande Donau-Drau-Sawe, *Vjesnik Arheološkog muzeja u Zagrebu*, 3.s., X–XI, 1977–78, 1–96.
- Dimitrijević 1979a:** Stojan Dimitrijević, Sjeverna zona, u: *Praistorija jugoslavenskih zemalja* II, Sarajevo, 1979, 229–363.
- Dimitrijević 1979b:** Stojan Dimitrijević, Badenska kultura, u: *Praistorija jugoslavenskih zemalja* III, Sarajevo, 1979, 183–234.
- Dimitrijević 1979c:** Stojan Dimitrijević, Vučedolska kultura i vučedolski kulturni kompleks, u: *Praistorija jugoslavenskih zemalja* III, Sarajevo, 1979, 267–341.
- Dizdar & Krznarić-Škrivanko 2000:** Marko Dizdar & Maja Krznarić-Škrivanko, Prilog poznavanju arhitekture starčevačke kulture u Vinkovcima, *Vjesnik Arheološkog muzeja u Zagrebu*, 3.s., XXXII–XXXIII (1999–2000), Zagreb, 2000, 7–22.
- Durman et al. 2003:** Aleksandar Durman, Jacqueline Balen & Mirela Hutinec, Nastavak sustavnih istraživanja na lokalitetu Vučedol – vinograd Streim, *Obavijesti Hrvatskog arheološkog društva*, XXXV/1, 2003, 46–50.
- Durman 1983:** Aleksandar Durman, Metalurgija vučedolskog kulturnog kompleksa, *Opuscula Archaeologica*, 8, Zagreb 1983,

- Durman 1984:** Aleksandar Durman, Ostava kalupa vučedolskog lijevača bakra iz Vinkovaca, *Izdanja Hrvatskog arheološkog društva*, 9, *Arheološka istraživanja u istočnoj Slavoniji i Baranji*, Zagreb, 1984, 37–52.
- Durman 1995:** Aleksandar Durman, Psihologija naseljavanja telova, *Histria Antiqua*, 1, Pula, 153–158.
- Eibner 1973:** Clemens Eibner, Die urnenfelderzeitlichen Sauggefasse. Ein Beitrag zur morphologischen und ergologischen Umschreibung, *Præhistorische Zeitschrift*, Band 48, Heft 2, 1973, 144–199.
- Garašanin 1951:** Milutin Garašanin, *Hronologija vinčanske kulture*, Ljubljana, 1951.
- Garašanin 2001:** Milutin Garašanin, Cernavodă III-Boleráz und der Balkan, *Cernavodă III – Boleráz*, Studia danubiana, Bucuresti, 2001, 369–384.
- Geografija 1975:** Geografija SR Hrvatske, Istočna Hrvatska, knjiga 3, Školska knjiga, Zagreb, 1975.
- Govedarica 2001:** Blagoje Govedarica, Die Funde vom Typ Cernavodă III-Boleráz im ehemaligen Jugoslawien, *Cernavodă III – Boleráz*, Studia danubiana, Bucuresti, 2001, 358–368.
- Grubišić 2002:** Ante Grubišić, Arheolog Dr. Robert Rudolf Schmidt u Hrvatskoj, *Osječki zbornik*, 26, Osijek, 2002, 107–134.
- Höernes 1901:** Moritz Höernes, Funde verschiedener Alterstufen aus dem westlichen Syrmien, *Mitteilungen der Prähistorischen Commission*, I, 5, Wien, 1901.
- Höernes & Mengin 1925:** Moritz Höernes & Oswald Menghin, *Urgeschichte der bildenden Kunst in Europa*, Wien, 1925.
- Hoffiller 1938:** Viktor Hoffiller, Sarvaš, u: *Corpus vasorum antiquorum Yougoslavie*, Fasc. 2, Beograd, 1938.
- Hoti 1990:** Marina Hoti, Novi nalazi konserativnih rogova na Vučedolu, *Opuscula Archaeologica*, 14, Zagreb, 1990, 33–42.
- Ivanov & Nikolov 1986:** Ivan S. Ivanov & Vassil Nikolov, Katalog, u: *Das erste Gold der Menschheit. Die älteste Zivilisation in Europa*, Freiburg, 1986, 51–137.
- Kalicz 1976:** Nándor Kalicz, Ein neues kupferzeitliches Wagenmodell aus der Umgebung von Budapest, u: *Festschrift für R. Pittioni zum 70. Geburtstag*, Wien, 1976, 188–202.
- Karavanić & Balen 2003:** Ivor Karavanić & Jacqueline Balen, *Osvit tehnologije*, katalog izložbe, Arheološki muzej u Zagrebu, Zagreb, 2003.
- Karmanski 2005:** Sergej Karmanski, *Donja Branjevina: A neolithic settlement near Seronje in the Vojvodina (Serbia)*, Società per la Preistoria e Protostoria della regione Friuli-Venezia Giulia, quaderno 10, Trieste, 2005.
- Katalog AMZ 1993:** *Arheološki muzej u Zagrebu: Izbor iz fundusa*, katalog, ed. Ante Rendić-Miočević, Zagreb, 1993.
- Krznarić-Škrivanko 1997:** Maja Krznarić-Škrivanko, Prapovijesno naselje na Ervenici u Vinkovcima, *Opuscula Archaeologica*, 21, Zagreb, 1997, 205–215.
- Krznarić-Škrivanko 1999:** Maja Krznarić-Škrivanko, Mlađe kameno doba, u: *Vinkovci u svijetu arheologije*, katalog izložbe, Vinkovci, 1999, 11–19.
- Krznarić-Škrivanko 2003:** Maja Krznarić-Škrivanko, Neki naseobinski pokazatelji na eponimnom lokalitetu sopotske kulture, *Opuscula Archaeologica*, 27, Zagreb, 2003, 63–69.
- Machnik 1991:** Jan Machnik, *The earliest bronze age in the Carpatian Basin*, Bradford University, 1991.
- Makkay 1987:** János Makkay, Kontakte zwischen der Körös – Starčevo Kultur und der Linienbandkeramik, *Communicationes Archaeologicae Hungariae*, 1987, 15–24.
- Makkay et al. 1996:** János Makkay, Elisabetta Starnini & Magdolna Tulok, *Excavations at Bicske-Galagonyás (part III), The Notenkopf and Sopot-Bicske cultural phases*. Società per la Preistoria e Protostoria della regione Friuli-Venezia Giulia, 6, Trieste, 1996.
- Marijanović 2005:** Brunislav Marijanović, *Gudnja višeslojno prapovijesno nalazište*, Dubrovački muzeji – Arheološki muzej, Dubrovnik, 2005.
- Marković 1993:** Zorko Marković, Neolitička, eneolitička i ranobrončanodobna naselja u sjevernoj Hrvatskoj, *Izdanja Hrvatskog arheološkog društva*, 16, *Arheološka istraživanja u Slavanskom Brodu i Brodskom Posavlju*, Zagreb, 1993, 113–125.
- Marković 1994:** Zorko Marković, *Sjeverna Hrvatska od neolita do brončanog doba*, Koprivnica, 1994.
- Marković 2002:** Zorko Marković, Grabrovac kod Đakova i početak brončanog doba u sjevernoj Hrvatskoj, *Prilozi Instituta za arheologiju u Zagrebu*, 19, Zagreb, 2002, 31–46.
- Miličević 1984:** Marina Miličević, Rekonstrukcija ženske odjeće u eneolitiku međurječja Dunava, Drave i Save, *Opuscula Archaeologica*, 9, Zagreb, 1984, 1–22.
- Miličević 1988:** Marina Miličević, Religija vučedolske kulture, u: *Vučedol – treće tisućljeće p.n.e.*, katalog izložbe, Zagreb, 1988, 30–31.
- Miličević Bradač 2005:** Marina Miličević Bradač, The transfer of symbols and meanings: the case of the »horns of consecration«, *Documenta Praehistorica*, XXXII, Ljubljana, 2005, 187–196.
- Milojčić 1943:** Vladimir Milojčić, Das vorgeschichtliche Bergwerk Šuplja Stena am Avalaberg bei Belgrad in Serbien, *Wiener Prähistorische Zeitschrift*, XXX, Berlin, 1943, 41–54.
- Milojčić 1949:** Vladimir Milojčić, *Chronologie der jungen Steinzeit Mittel- und Sudeuropas*, Berlin, 1949.
- Milojčić 1953:** Vladimir Milojčić, Funde der Kostolacer Kultur in der Sammlung des Vorgeschichtlichen Seminars in Marburg/Lahn, *Prähistorische Zeitschrift*, XXXIV/V (1949/1950), Berlin, 1953, 151–158.
- Minichreiter 1991:** Kornelija Minichreiter, Arheološka istraživanja na dijelu auto-ceste Slavonski Brod – Lipovac, *Godišnjak zaštite spomenika kulture Hrvatske*, 17 (1991), Zagreb, 1993, 179–192.
- Minichreiter 1992a:** Kornelija Minichreiter, *Starčevačka kultura u sjevernoj Hrvatskoj*, Dizertacije i monografije 1, Zagreb, 1992.
- Minichreiter 1992b:** Kornelija Minichreiter, Kulturni predmeti starčevačke kulture u sjevernoj Hrvatskoj, *Prilozi*, 9, Zagreb, 1992, 7–22.
- Minichreiter 1997:** Kornelija Minichreiter, Otkriće u Lukaču i Požegi ao prilog poznavanju topografije naselja starčevačke kulture u sjevernoj Hrvatskoj, *Prilozi*, 11–12 (1994–1995), Zagreb, 1997, 7–36.
- Minichreiter 2000:** Kornelija Minichreiter, Reljefni prikaz ženskog lika na posudama starčevačke kulture, *Prilozi Instituta za arheologiju*, 17, Zagreb, 2000, 5–15.
- Minichreiter 2005:** Kornelija Minichreiter, Arheološka istraživanja na Galovu u Slavanskom Brodu, *Annales Instituti Archaeologici*, I, Zagreb, 2005, 25–30.
- Muzeopis 1996:** *Muzeopis*, katalog izložbe, ed. Dubravka Balen & Zdenka Dukat, Arheološki muzej u Zagrebu, Zagreb, 1996.

- Die Neandertaler 1994:** *Die Neandertaler und die anfänge Europas*, katalog izložbe, Eisenstadt, 1994.
- Nikolić 2000:** Dubravka Nikolić, *Kostolačka kultura na teritoriji Srbije*, Beograd, 2000.
- Orion 2000:** Aleksandar Durman, *Vučedolski Orion i najstariji europski kalendar*, Gradski muzej Vukovar, 2000. (*The Vučedol Orion and the oldest European calendar, catalogue of the exhibition*)
- Parzinger 1993:** Herman Parzinger, *Studien zur Chronologie und Kulturgeschichte der Jungstein-, Kupfer- und Frühbronzezeit zwischen Karpaten und Mittlerem Taurus*, Römisch-Germanische Forschungen, band 52, Mainz am Rhein, 1993.
- Perić 1995:** Slavica Perić, *Butmirska kultura*, Beograd, 1995.
- Perišić 1984:** Svetlana Perišić, *Predmeti od kosti, roga i kamena*, Muzej grada Beograda, Katalog XIII, Beograd, 1984.
- Petrović & Jovanović 2002:** Jelka Petrović & Borislav Jovanović, *Gomolava, naselja kasnog eneolita*, Novi Sad-Beograd, 2002.
- Reinecke 1897:** Paul Reinecke, Ueber einige prähistorische Wohnstätten in Slavonien, *Mittheilungen der Anthropologischen Gesellschaft in Wien*, XXVII, 3, Wien, 1897, 78–80.
- Saveljić Bulatović & Lutovac 2003:** Lenka Saveljić Bulatović & Predrag Lutovac, *Zlatno doba Crne Gore*, katalog izložbe, Annales Mediterranea, Podgorica, 2003.
- Schmidt 1945:** Robert Rudolf Schmidt, *Die Burg Vučedol*, Zagreb, 1945.
- Schuchhardt 1926:** Carl Schuchhardt, *Alteuropa, eine vorgeschichte unseres erdteils*, Berlin-Leipzig, 1926.
- Simbol 2006:** Aleksandar Durman, *Simbol boga i kralja*, katalog izložbe, Galerija Klovićevi dvori, Zagreb, 2006. (*Simbol of God and King, catalogue of the exhibition*)
- Šimić 1986a:** Jasna Šimić, Pokusno istraživanje na lokalitetu »Gradac« u Sarvašu, *Obavijesti Hrvatskog arheološkog društva*, XVIII/1, 1986, 23–24.
- Šimić 1986b:** Jasna Šimić, Zaštitno istraživanje na »Gracu« u Sarvašu, *Obavijesti Hrvatskog arheološkog društva*, XVIII./3, 37–38.
- Šimić 1987:** Jasna Šimić, Sarvaš/Gradac Prapovijesno višeslojno naselje, *Arheološki pregled* 1986, Ljubljana, 1987, 64–65.
- Šimić 1991:** Jasna Šimić, Ranobrončanodobno naselje na lokalitetu »Gradac« u Sarvašu, s naročitim obzirom na analizu keramičkog materijala, *Osječki zbornik*, 21, Osijek, 1991, 5–35.
- Šimić 1992:** Jasna Šimić, Horizont kasnoga brončanog doba na lokalitetu »Gradac« u Sarvašu, *Prilozi*, 9, 1992, 31–48.
- Šimić 1993:** Jasna Šimić, Kontinuitet nastanjivanja tijekom brončanog doba u sjeveroistočnoj Slavoniji, *Izdanja Hrvatskog arheološkog društva*, 16, *Arheološka istraživanja u Slavanskom Brodu i Brodskom Posavlju*, Zagreb, 1993, 127–148.
- Šimić 1995:** Jasna Šimić, *Umjetnost pretpovijesti istočne Slavonije i Baranje*, katalog izložbe, Osijek, 1995.
- Šimić 1997:** Jasna Šimić, Pododjel Prapovijesne arheologije, u: *Blago muzeja Slavonije*, katalog izložbe, Osijek 1997, 52–64.
- Šimić 2000:** Jasna Šimić, *Kulturne skupine s inkrustiranom keramikom u brončanom dobu sjeveroistočne Hrvatske*, Biblioteka Slavonije i Baranje – knjiga 2, Zagreb – Osijek, 2000.
- Šošić & Karavanić:** Rajna Šošić & Ivor Karavanić, Cijepani litički materijal s prapovijesnog nalazišta Slavča, Nova Gradiška, *Vjesnik Arheološkog muzeja u Zagrebu*, 3.s., XXXVII (2004), Zagreb, 2005, 17–41.
- Tasić 1967:** Nikola Tasić, *Badenski i vučedolski kulturni kompleks u Jugoslaviji*, dissertationes, Beograd, 1967.
- Tasić 1970:** Nikola Tasić, Genetische Probleme der gruppen Baden, Kostolac und Vučedol im jugoslawischen Donaugebiet und Zentralbalkan, *Balkanica*, I, 23–42.
- Tasić 1979:** Nikola Tasić, Kostolačka kultura, u: *Praistorija jugoslavenskih zemalja* III, Sarajevo, 1979, 235–266.
- Tasić 1984:** Nikola Tasić, Sremsko-slavonska regija kao nosilac evolucije na relaciji Baden-Kostolac-Vučedol, *Izdanja Hrvatskog arheološkog društva*, 9, *Arheološka istraživanja u istočnoj Slavoniji i Baranji*, Zagreb, 1984, 31–36.
- Tasić 1995:** Nikola Tasić, *Eneolithic cultures of central and west Balkans*, Belgrade, 1995.
- Tasić 2001:** Nikola Tasić, Die Cernavodă III–Boleráz-Kultur im westlichen Teil der jugoslawischen Donauniederung, *Cernavodă III – Boleráz*, Studia danubiana, Bucuresti, 2001, 342–357.
- Težak 1975:** Tihomila Težak, Vučedoler Kultgeräte aus Vinkovci, *Archaeologia Jugoslavica*, XVI, Beograd, 1975, 3–13.
- Težak-Gregl 1987:** Tihomila Težak-Gregl, Prilog poznavanju metalne produkcije badenske kulture, *Opuscula Archaeologica*, 11–12, Zagreb, 1987, 73–81.
- Težak-Gregl 1988:** Tihomila Težak-Gregl, O problemu idoloplastike u badenskoj kulturi, *Opuscula Archaeologica*, 13, Zagreb, 1988, 11–21.
- Težak-Gregl 1993:** Tihomila Težak-Gregl, *Kultura linearnotrakaste keramike u središnjoj Hrvatskoj*, Dizertacije i monografije 2, Zagreb, 1993.
- Težak-Gregl 1998:** Tihomila Težak-Gregl, Neolitik i eneolitik, u: *Prapovijest*, Zagreb, 1998, 59–157.
- Težak-Gregl 2003:** Tihomila Težak-Gregl, Prilog poznavanju neolitičkih obrednih predmeta u sjevernoj Hrvatskoj, *Opuscula Archaeologica*, 27, Zagreb, 2003, 43–48.
- Vasić 1936:** Miloje Vasić, *Preistoriska Vinča IV*, Beograd, 1936.
- Victor 1870:** Jean Victor, *Le pèlerin Slave*, Essek, 1870.
- Vinkovci 1999:** Marko Dizdar, Ivana Iskra-Janošić & Maja Krznarić-Škrivanko, *Vinkovci u svijetu arheologije*, katalog izložbe, Gradski muzej Vinkovci, Vinkovci, 1999.
- Vinski 1955:** Zdenko Vinski, Prethodni izvještaj o iskapanju nekropole na Lijevoj Bari u Vukovaru 1951., 1952. i 1953. godine, *Ljetopis Jugoslavenske akademije znanosti i umjetnosti*, 60, 1955, 231–255.
- Vinski 1961:** Zdenko Vinski, O oružju ranoga brončanog doba u Jugoslaviji, *Vjesnik Arheološkog muzeja u Zagrebu*, 3.s., II, Zagreb, 1961, 1–37.
- Vinski-Gasparini 1956:** Ksenija Vinski-Gasparini, Iskapanje prethistorijskog naselja u Belom Manastiru, *Osječki zbornik*, V, Osijek, 1956, 5–36.
- Vrdoljak 1994:** Snježana Vrdoljak, Tipološka klasifikacija kasnobrončanodobne keramike iz naselja Kalnik-Igrišće (SZ Hrvatska), *Opuscula Archaeologica*, 18, Zagreb, 1994, 7–81.
- Vučedol 1988:** *Vučedol – treće tisućljeće p.n.e.*, katalog izložbe, Muzejski prostor, Zagreb, 1988.
- Wosinski 1904:** Moriz Wosinski, *Die inkrustierte Keramik der Stein- und Bronzezeit*, Berlin, 1904.

## ***Table | Plates***

---

Pri crtanju materijala prikazanog na tablama korištena su različita mjerila.  
Točne dimenzije svakog predmeta mogu se naći u katalogu, str. 66–91.

The material represented on the plates was drawn at various scales.  
The precise dimensions of each item can be found in the catalogue,  
pps. 66–91.





Tabla I



Tabla 2



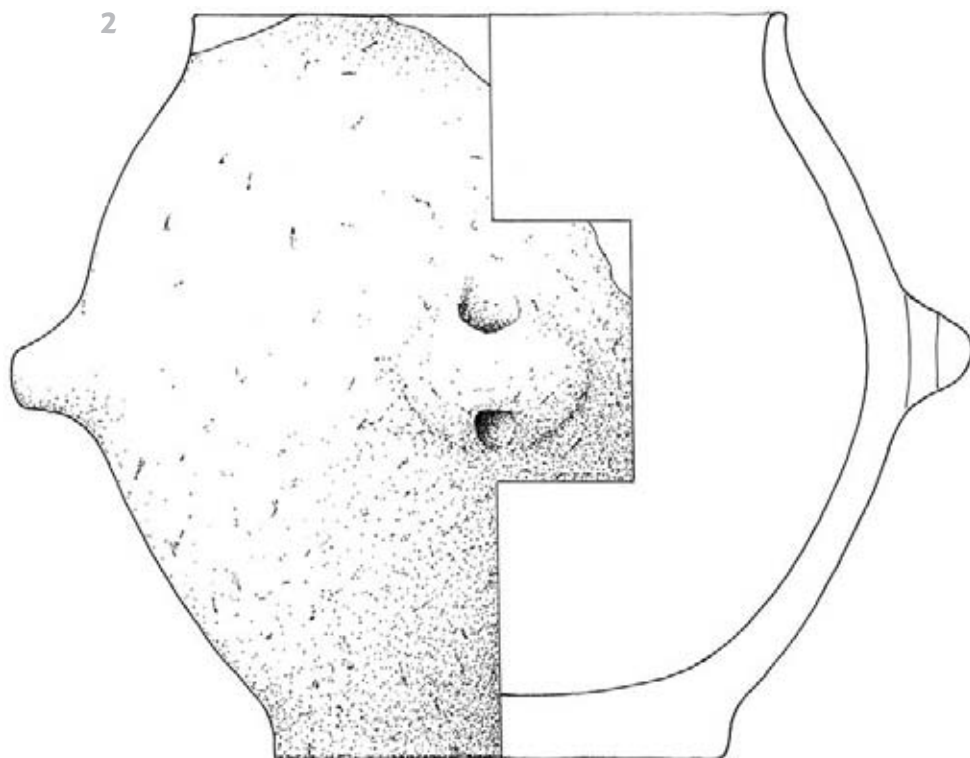
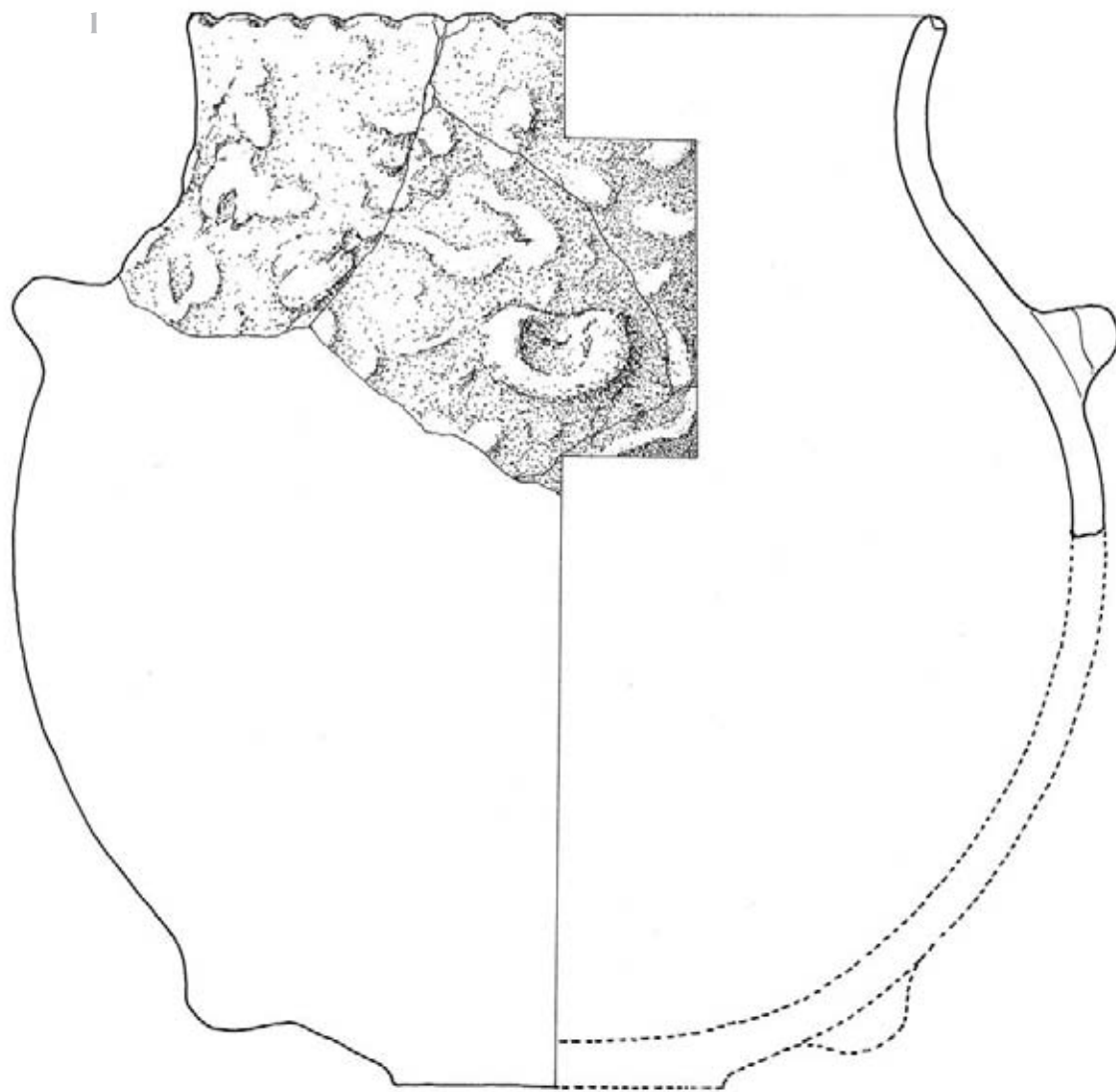

Tabla 4

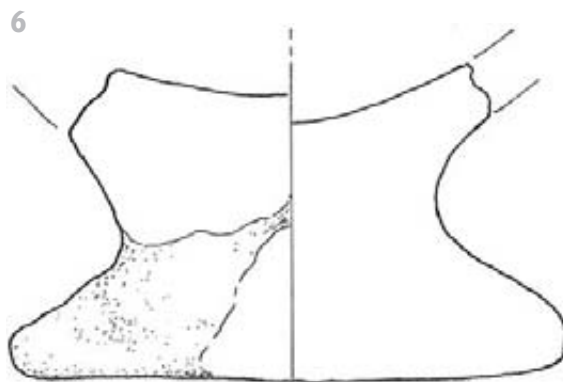
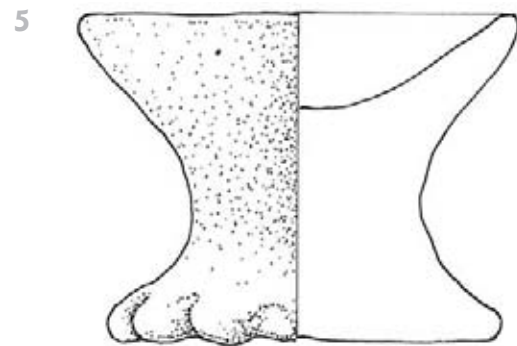
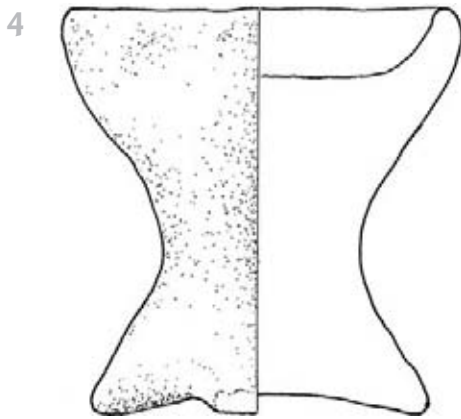
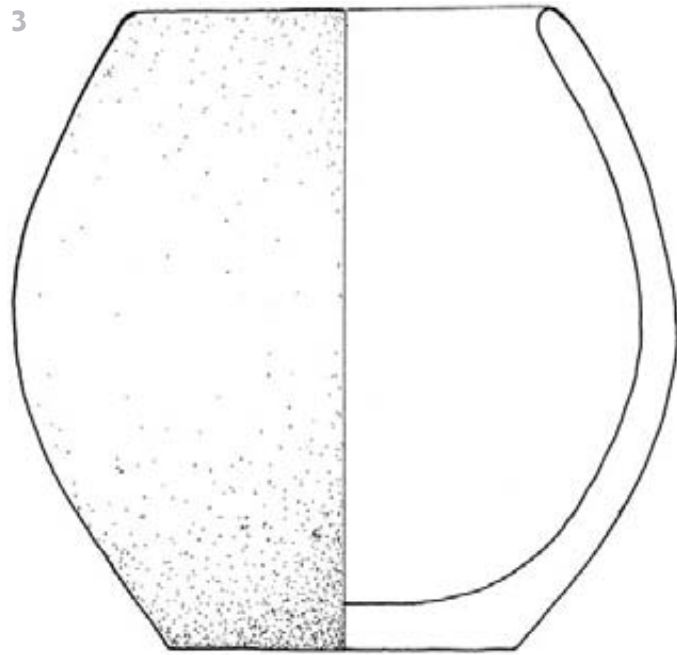
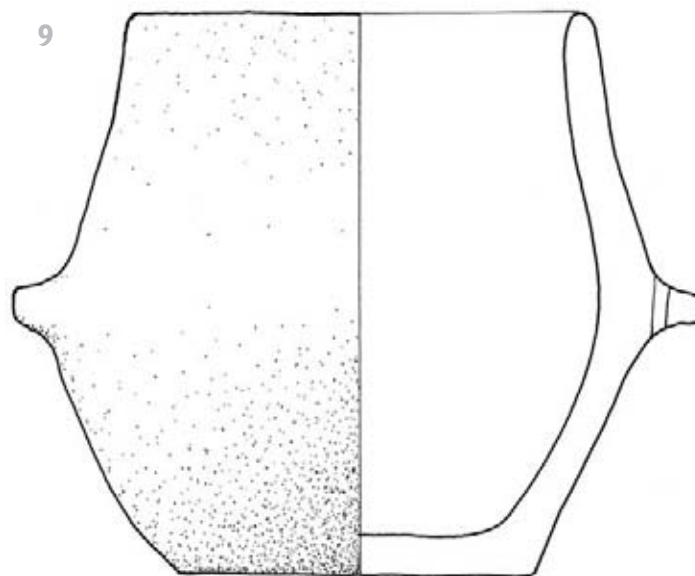
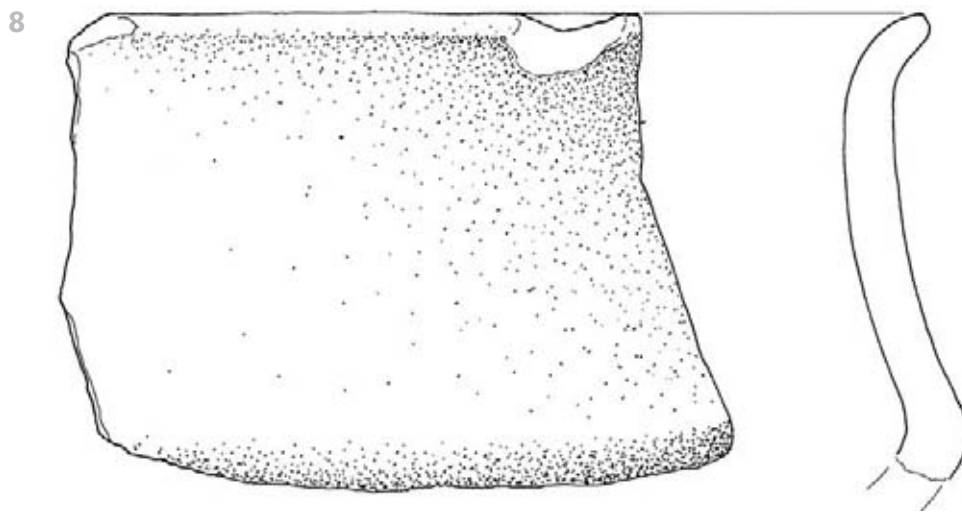
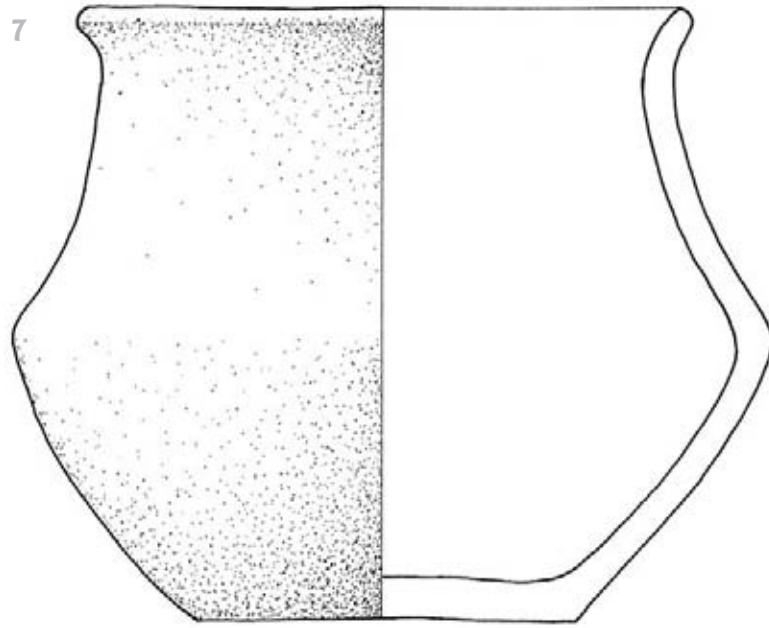
16



17

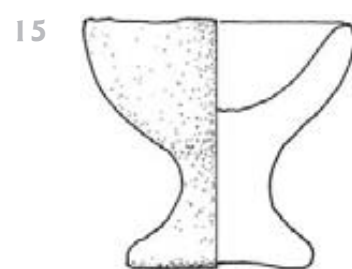
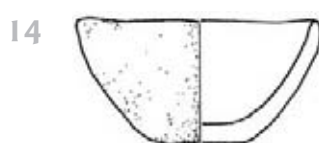
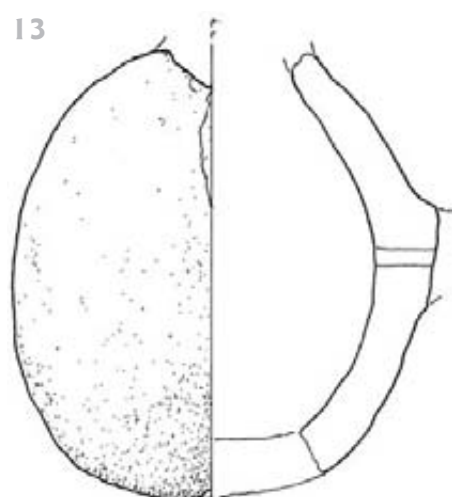
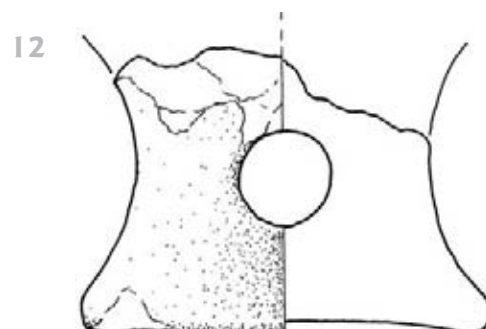
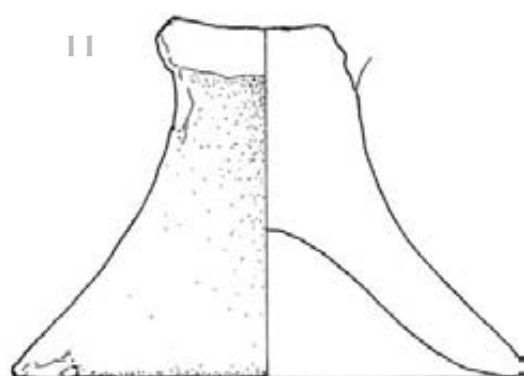
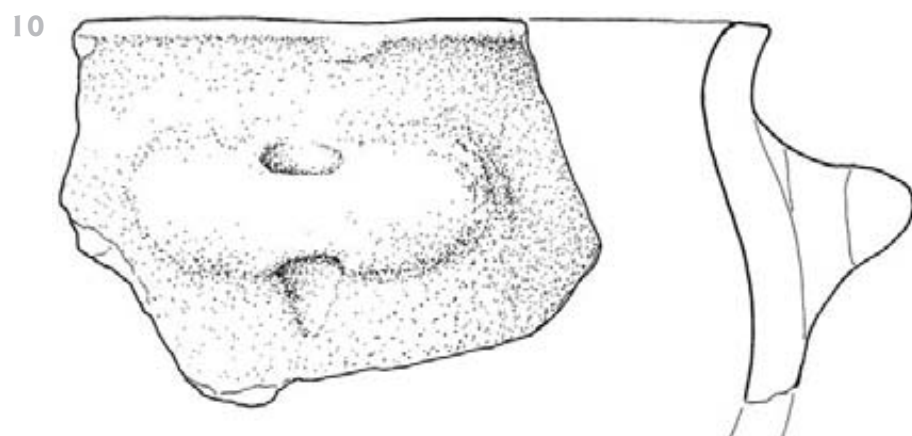
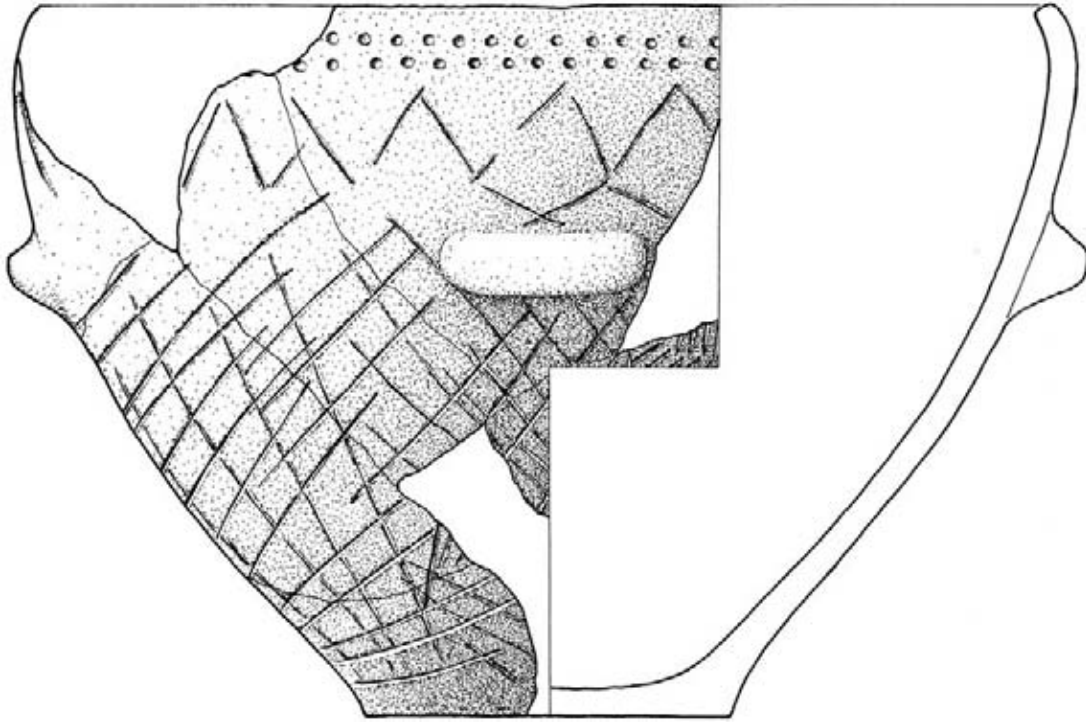
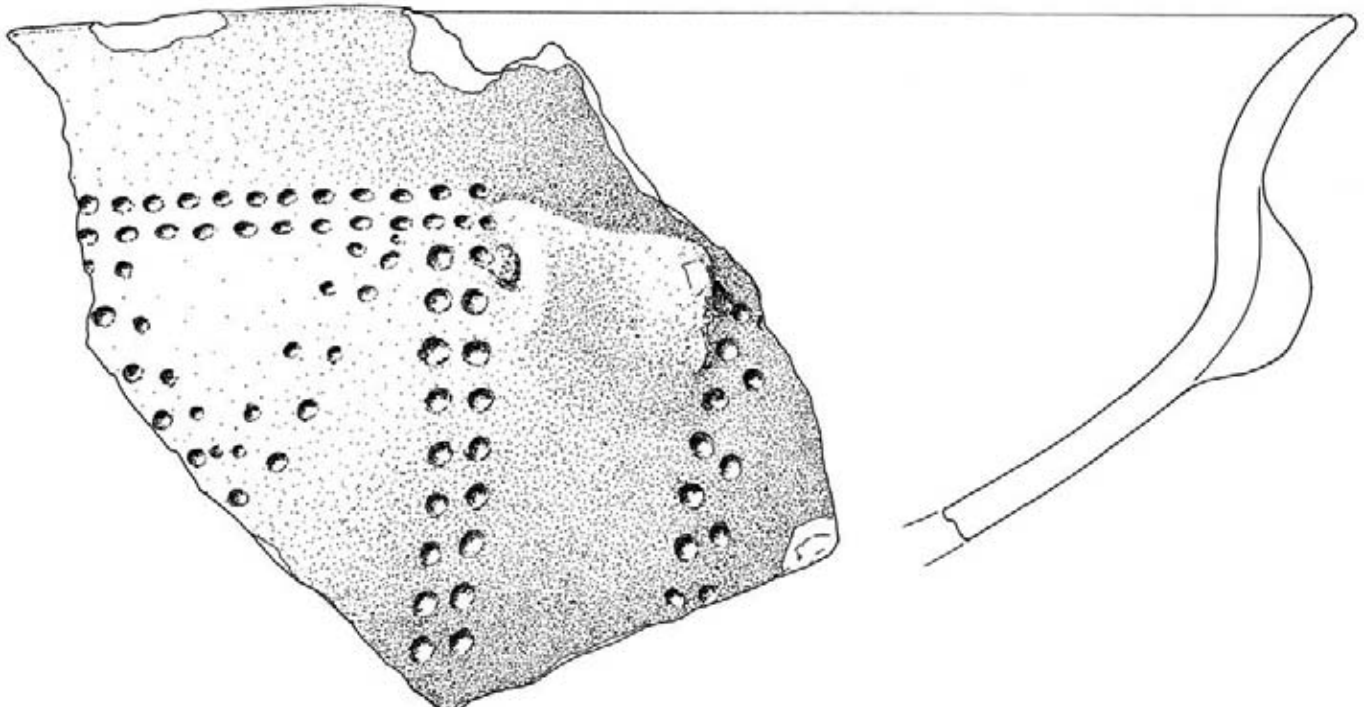

100

18



Tabla 5



Tabla 6

24

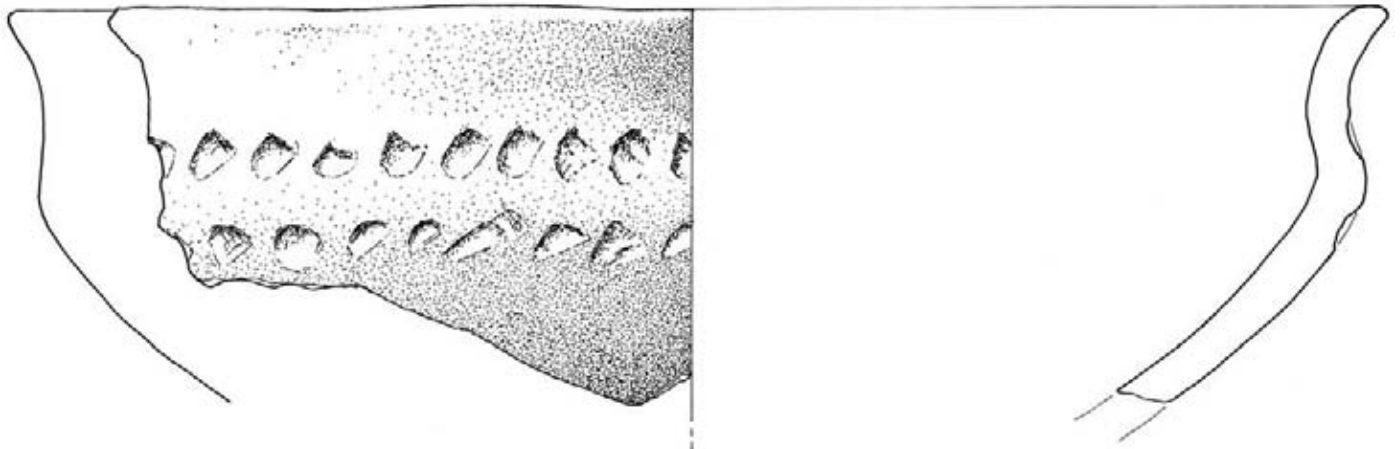

25

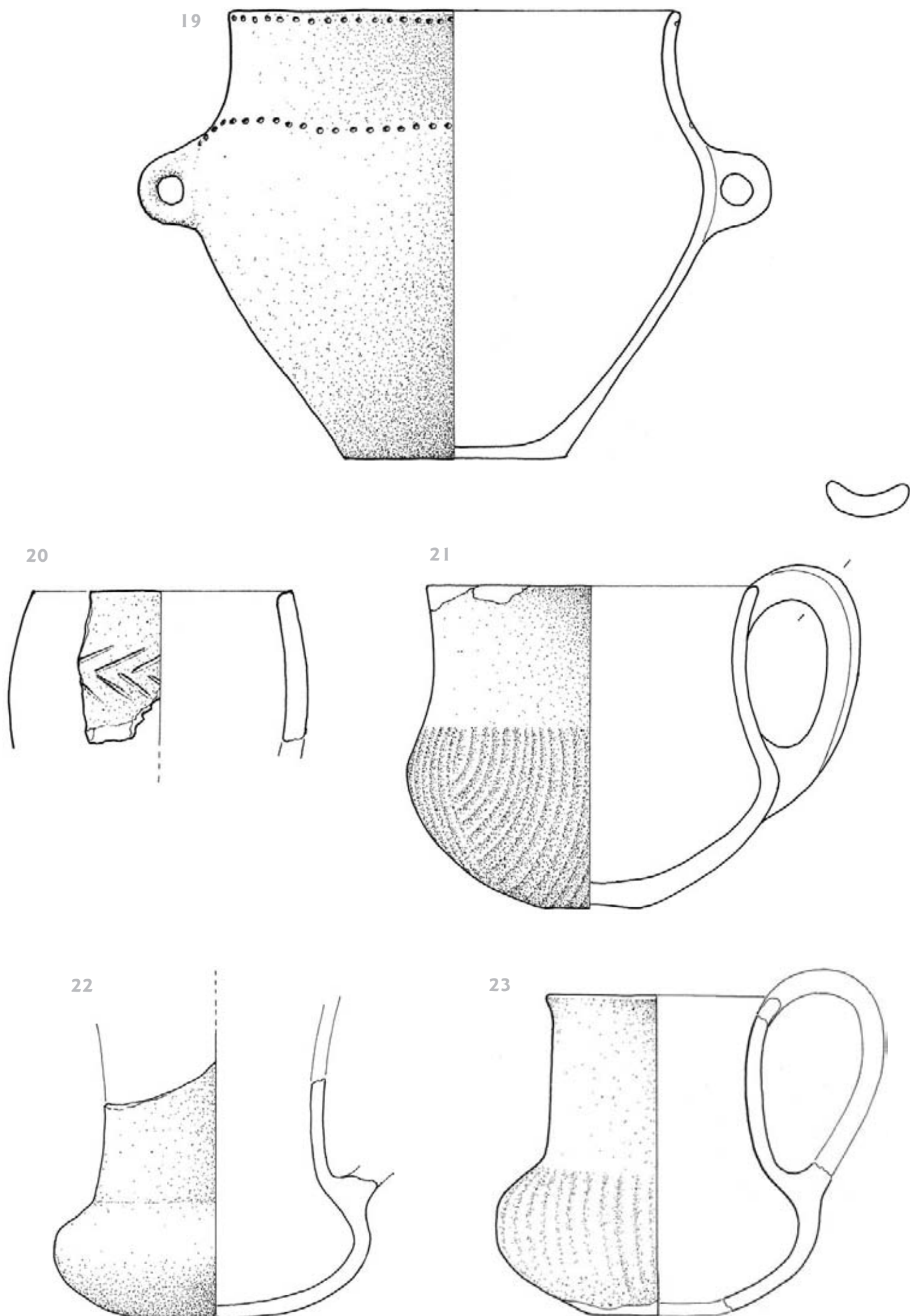
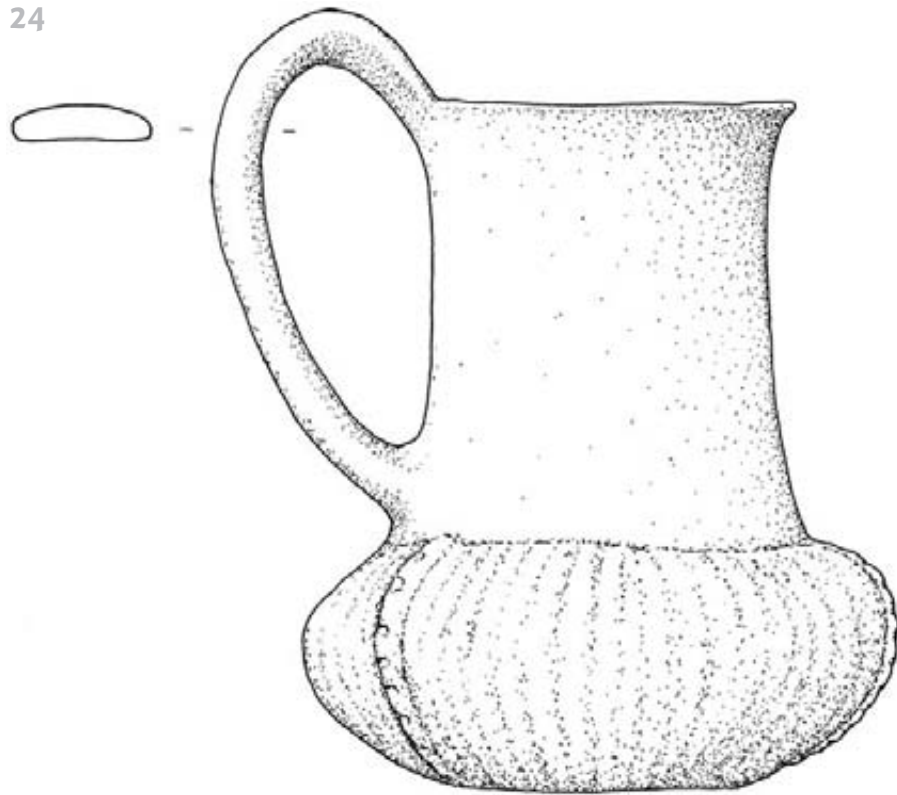

Tabla 7

26



27

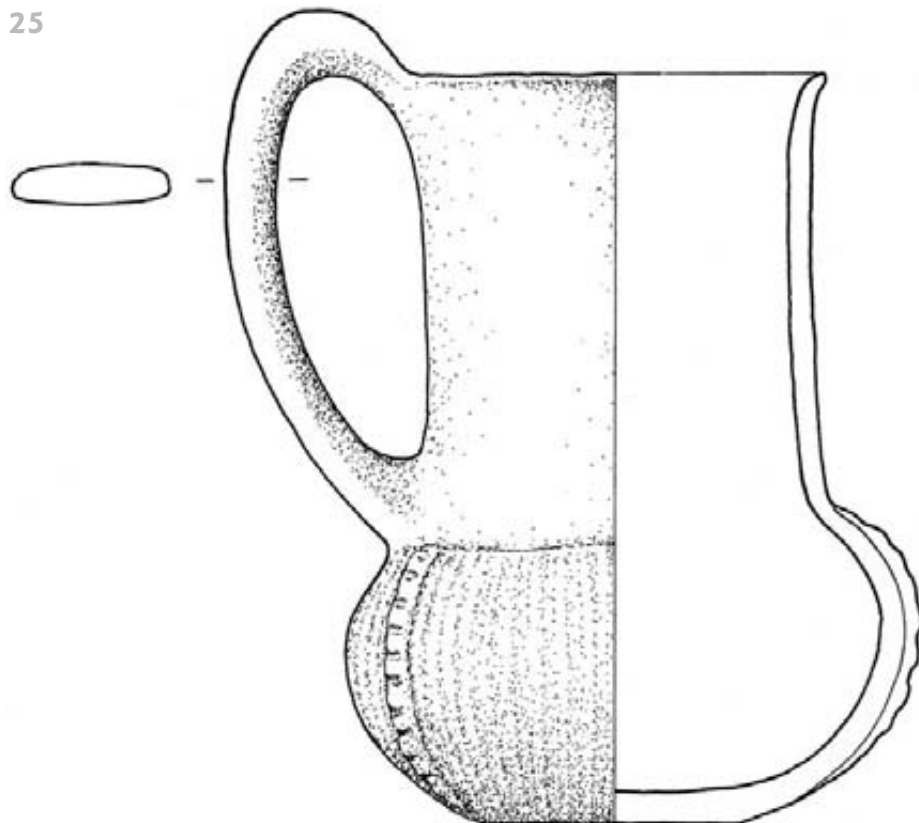
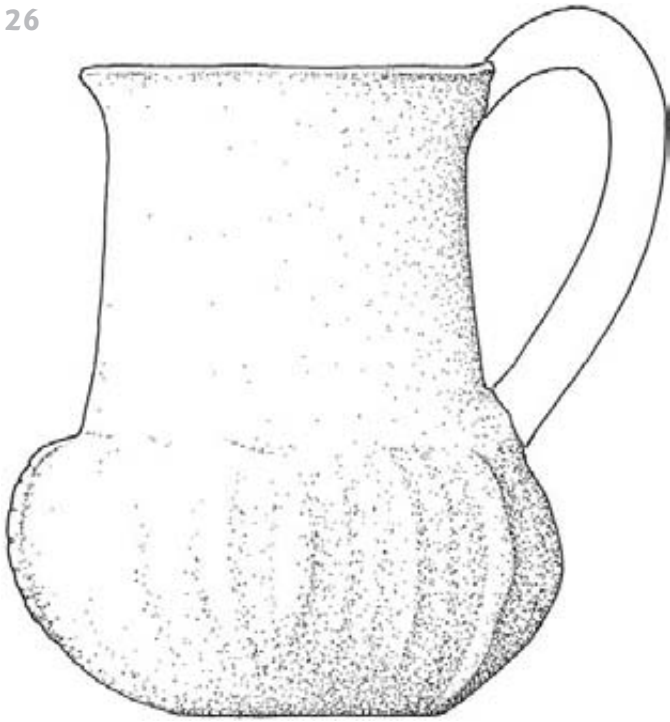
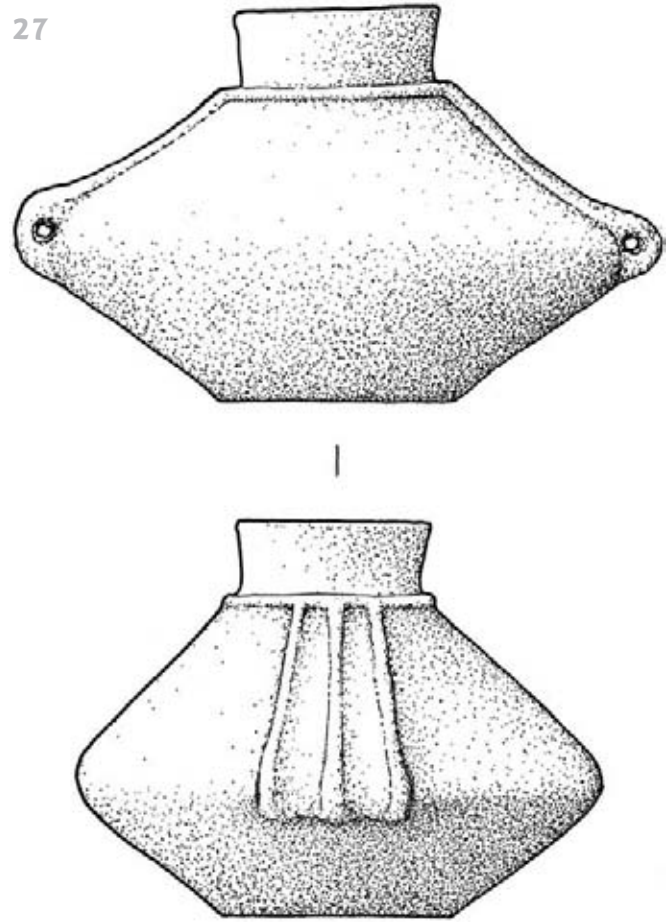

103

28



Tabla 8





34

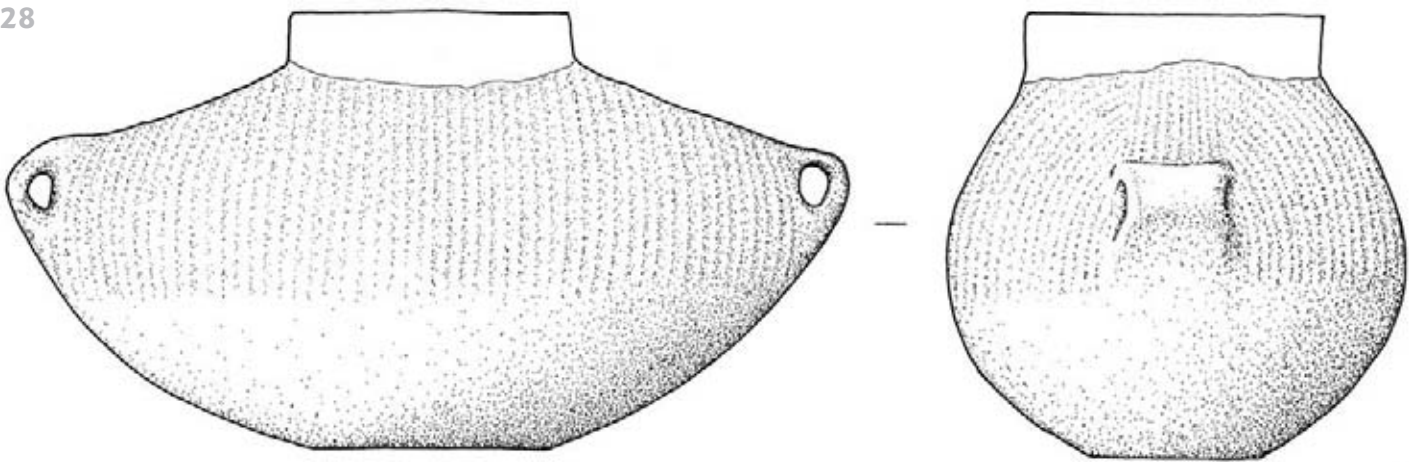
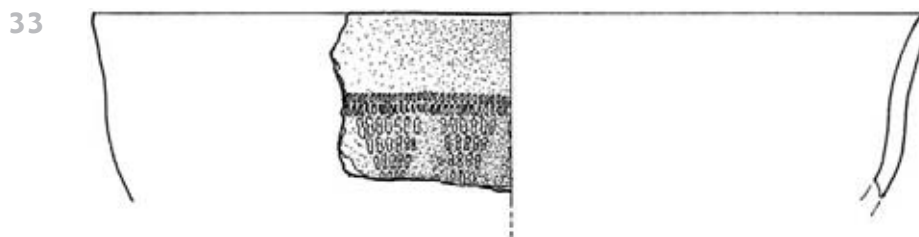
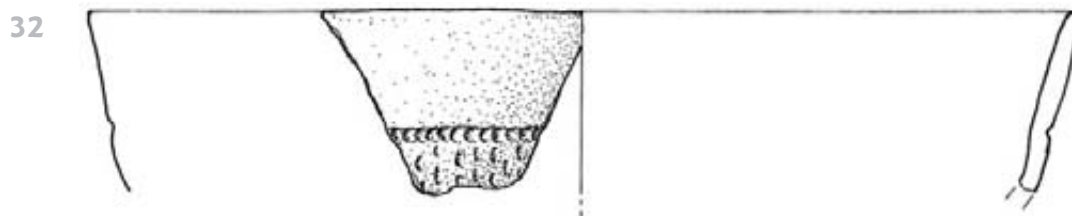
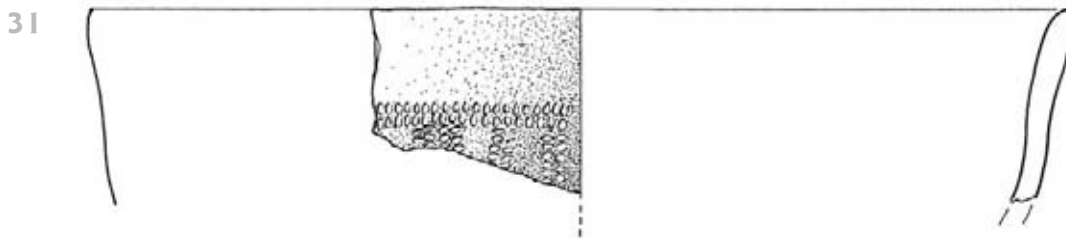
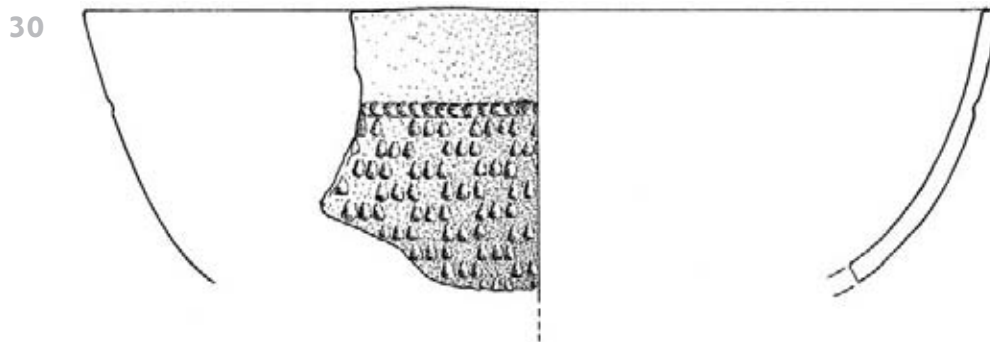
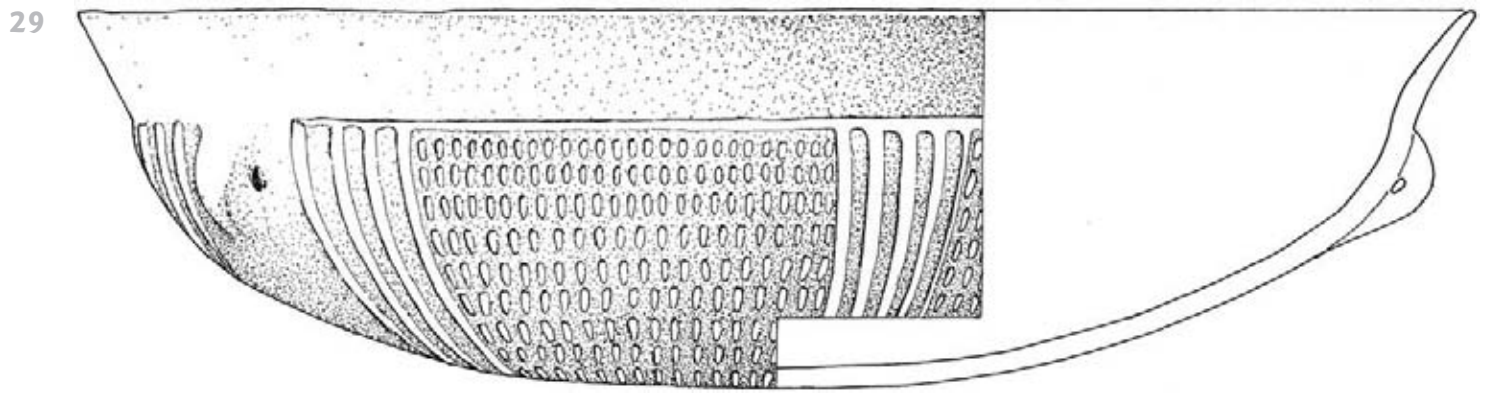
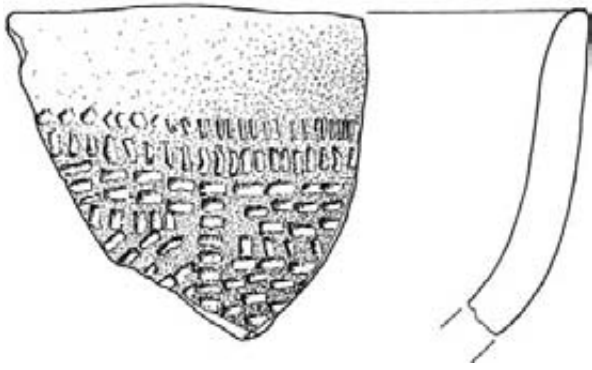

35

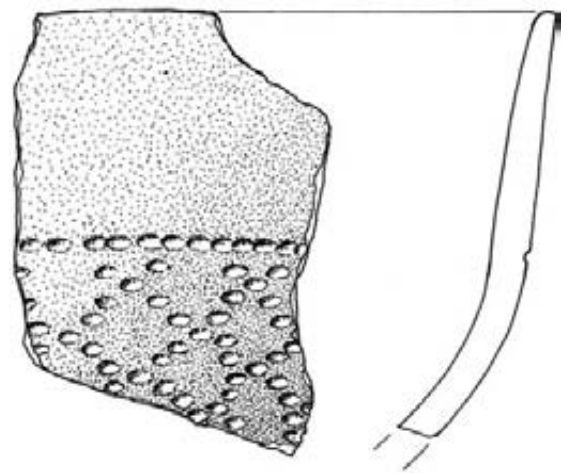

36

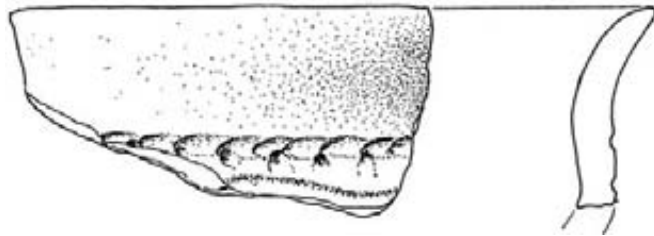

37

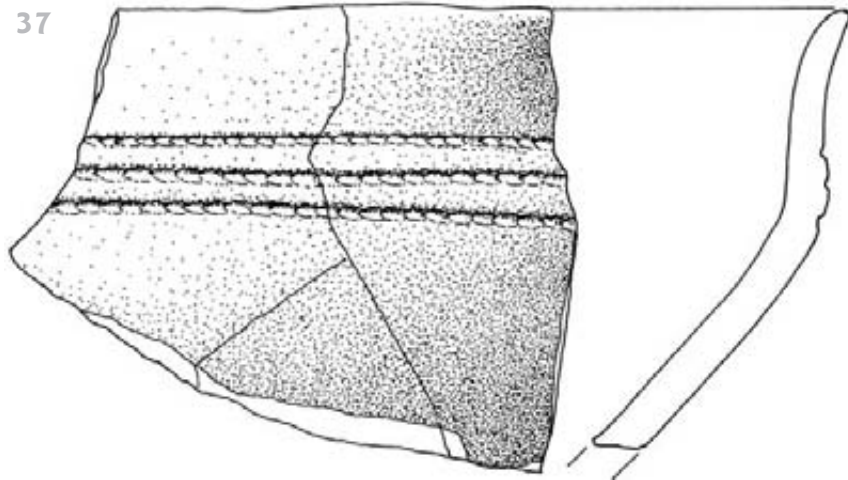

38

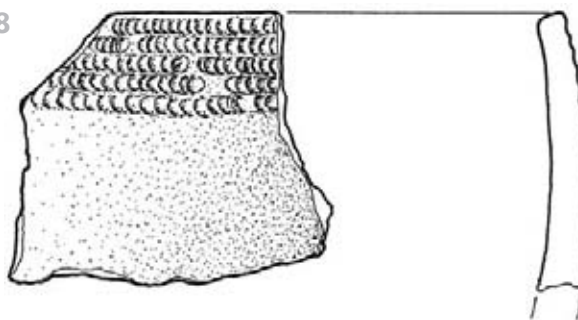

39

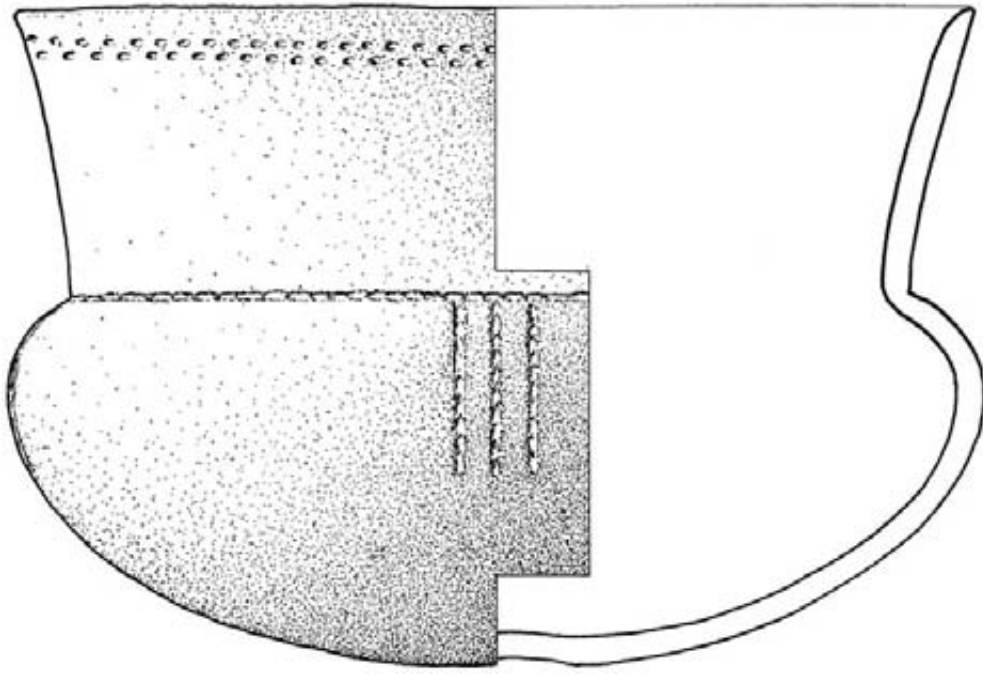

40

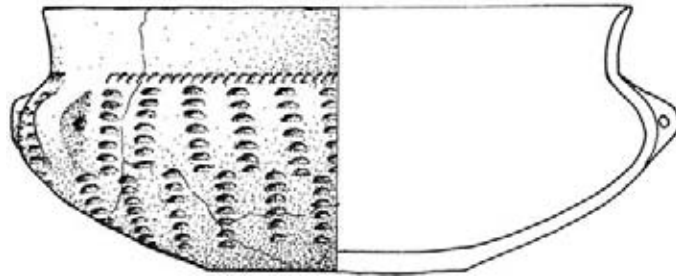

41

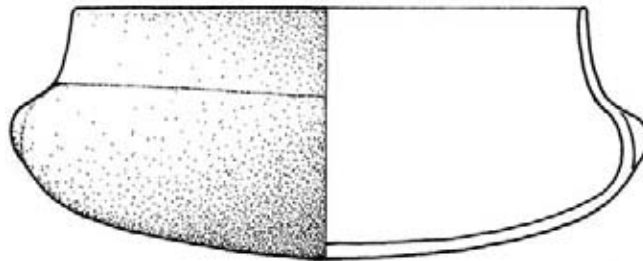

42

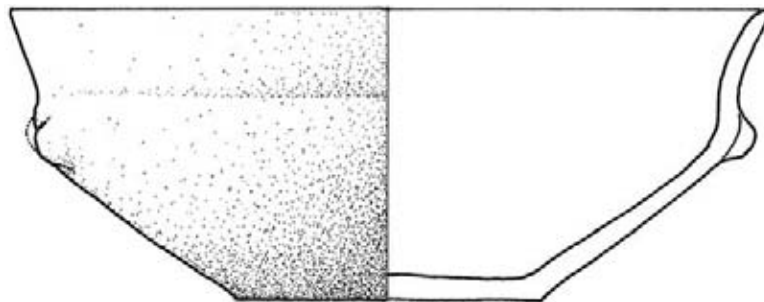

43

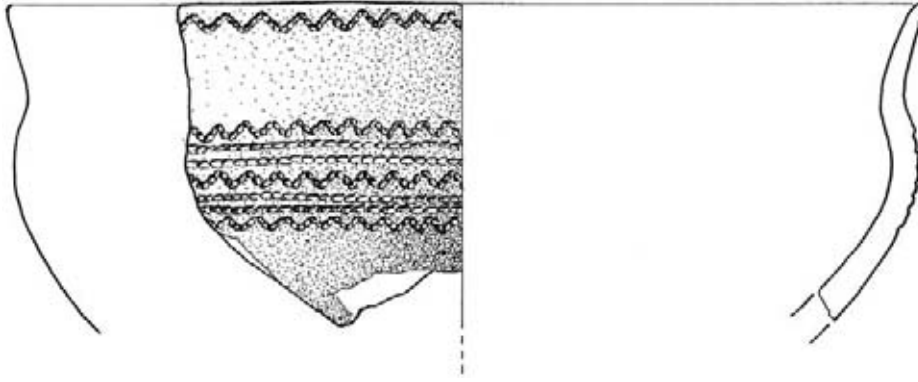

44

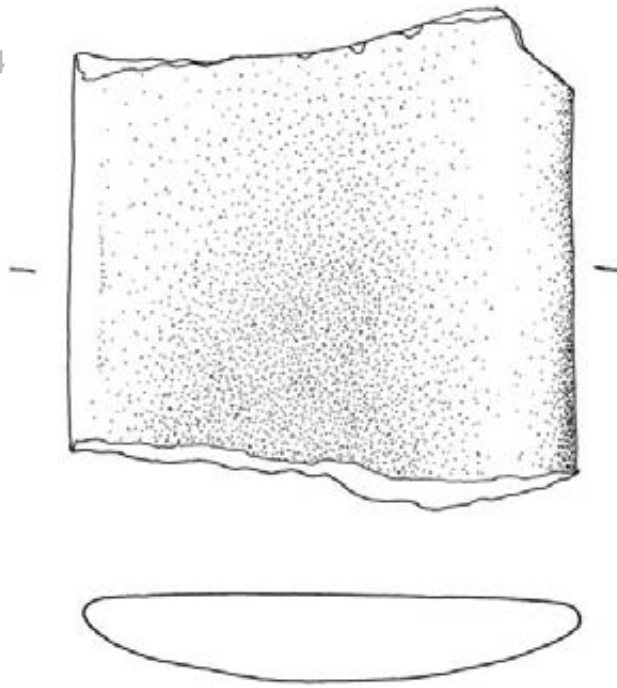

45

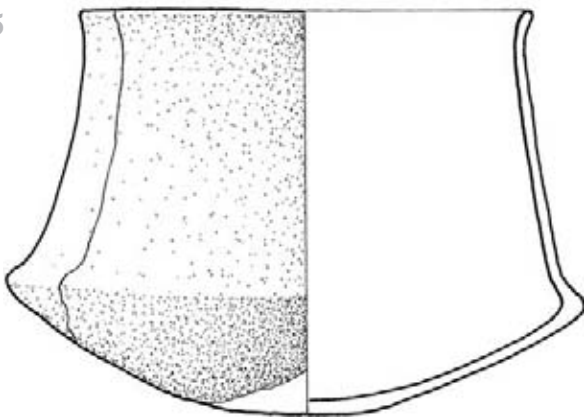

46



Tabla 12

47



48

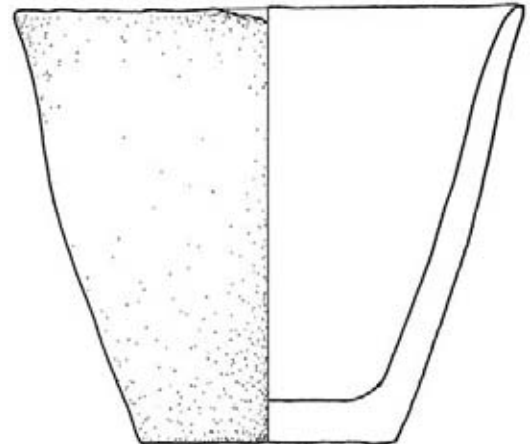
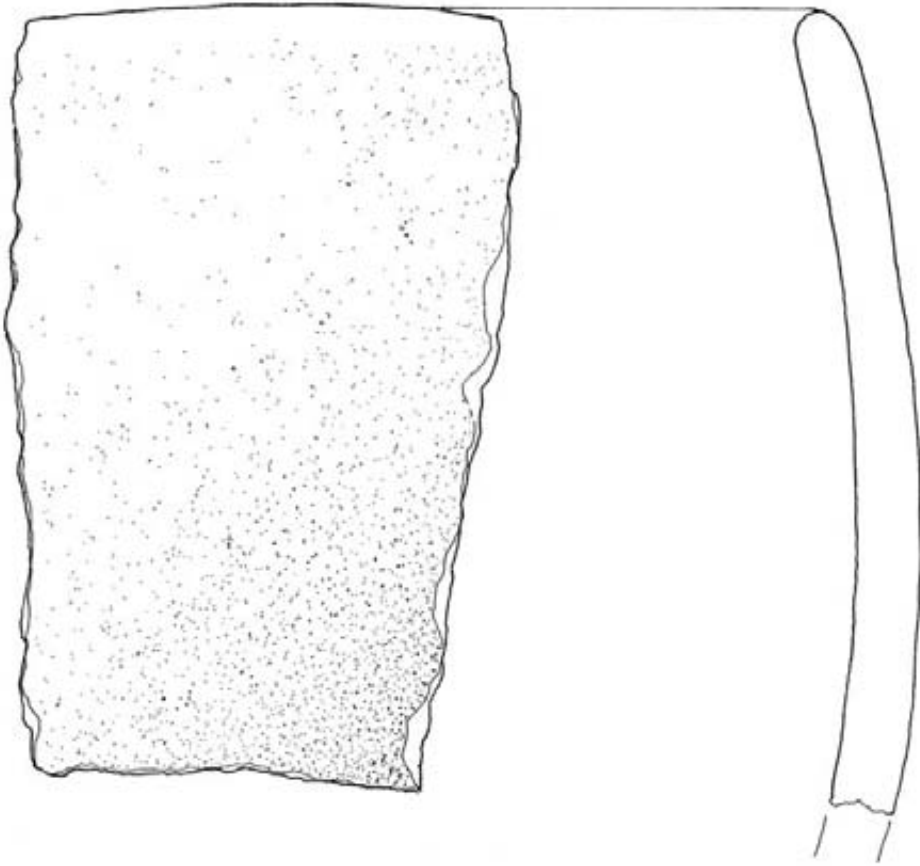

Tabla 13

49



50

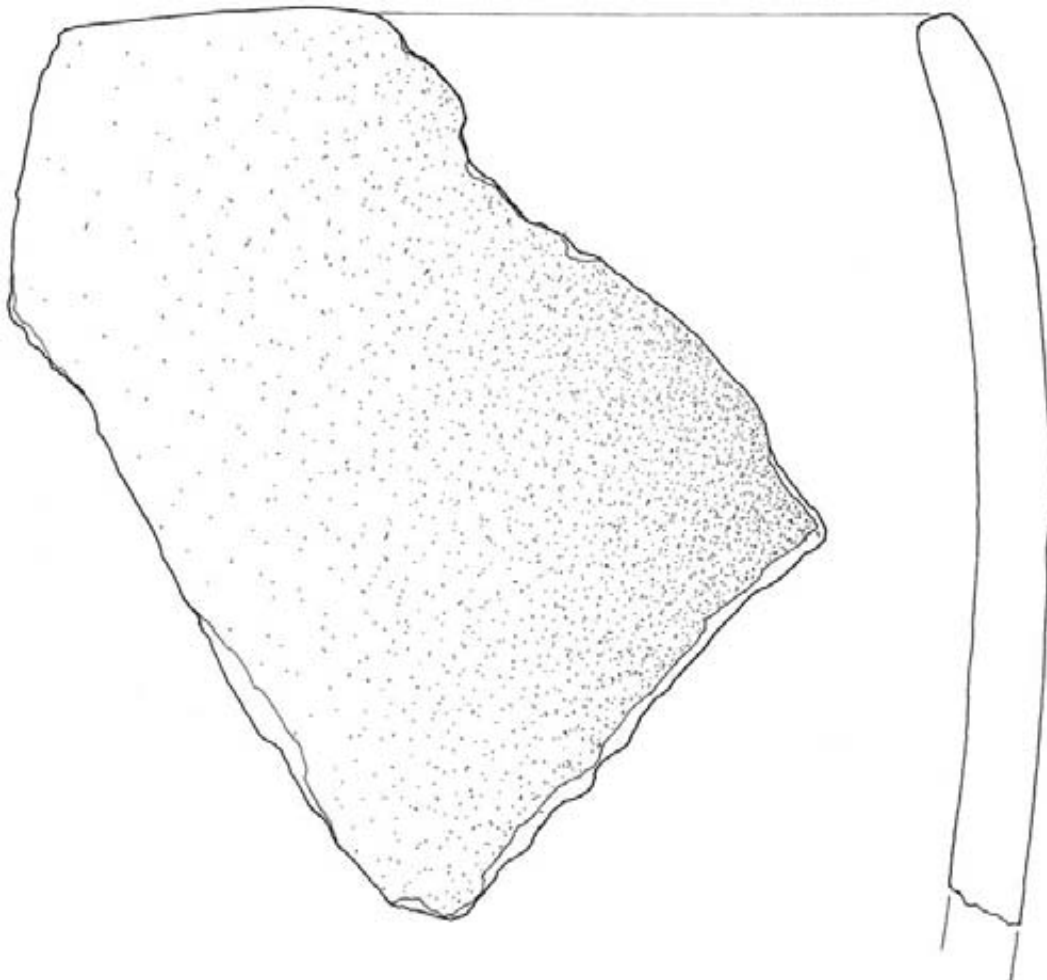
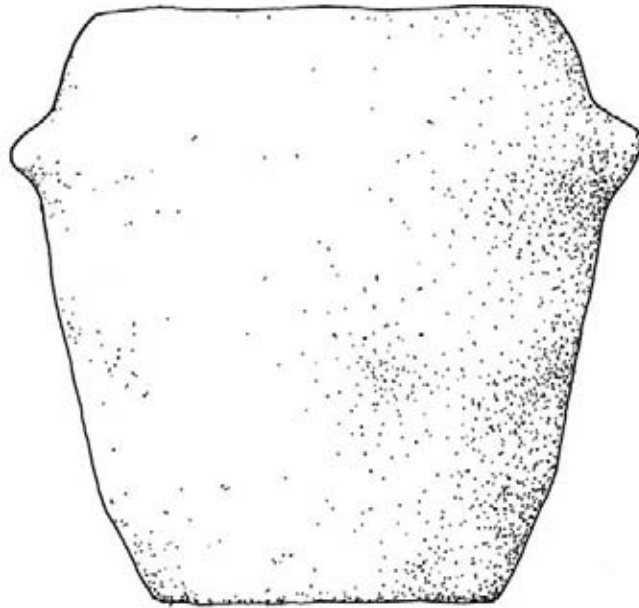
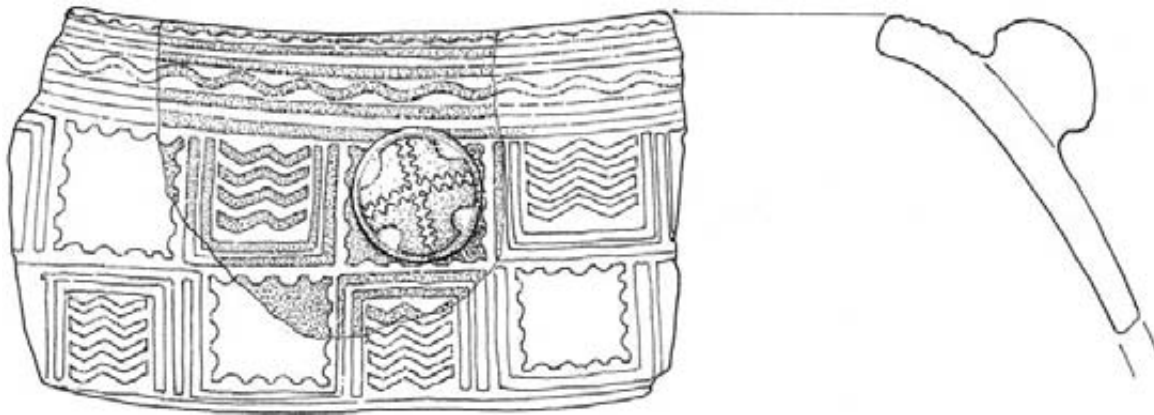

109

51



Tabla 14

52



53

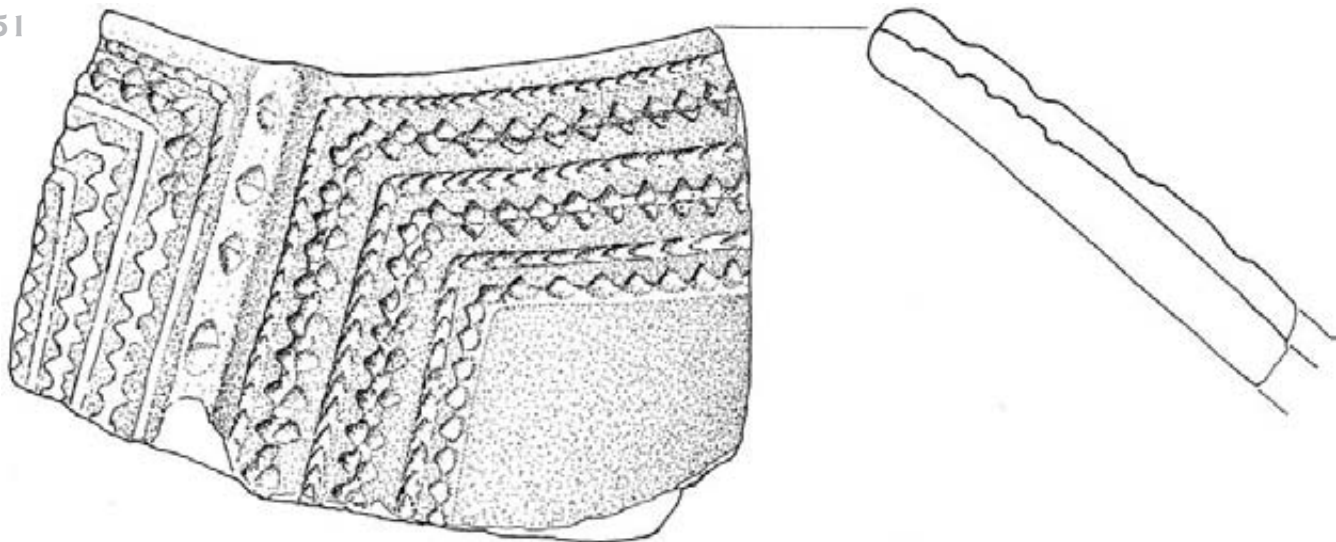
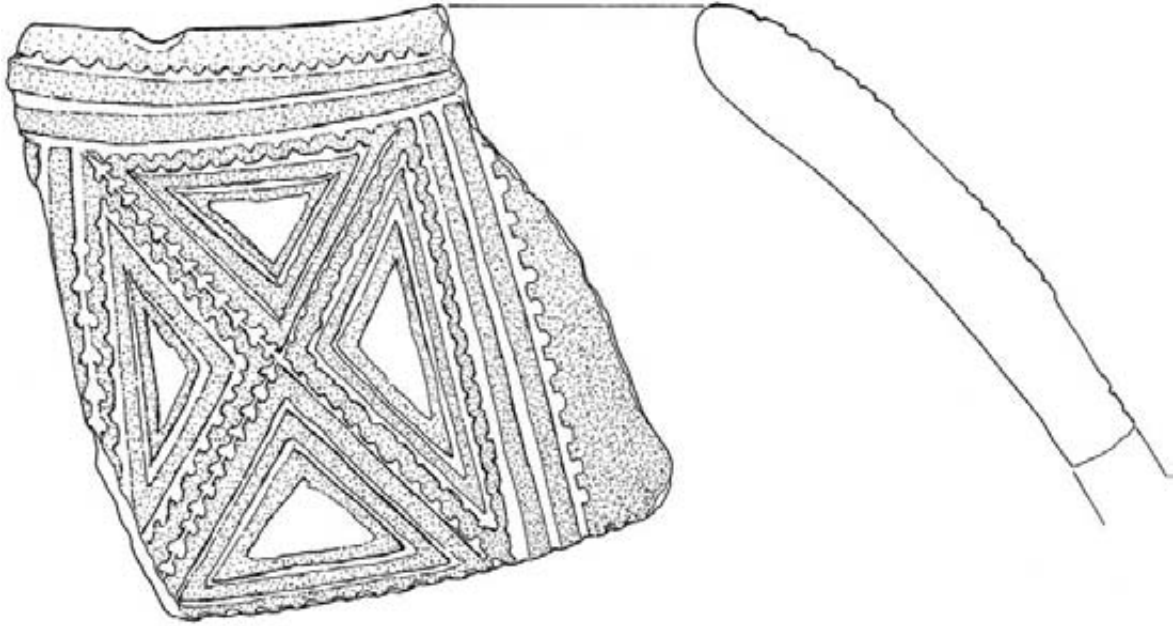
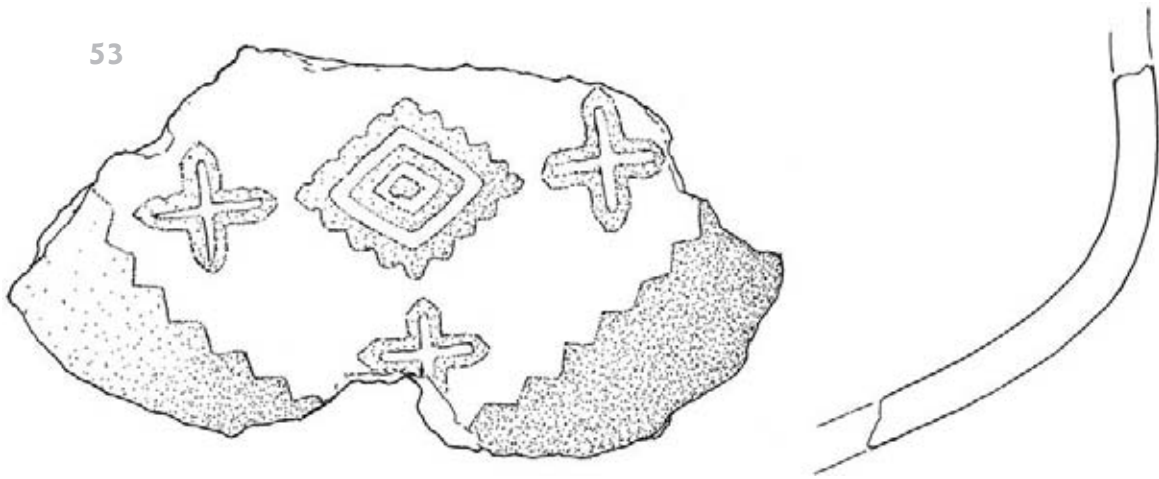

54

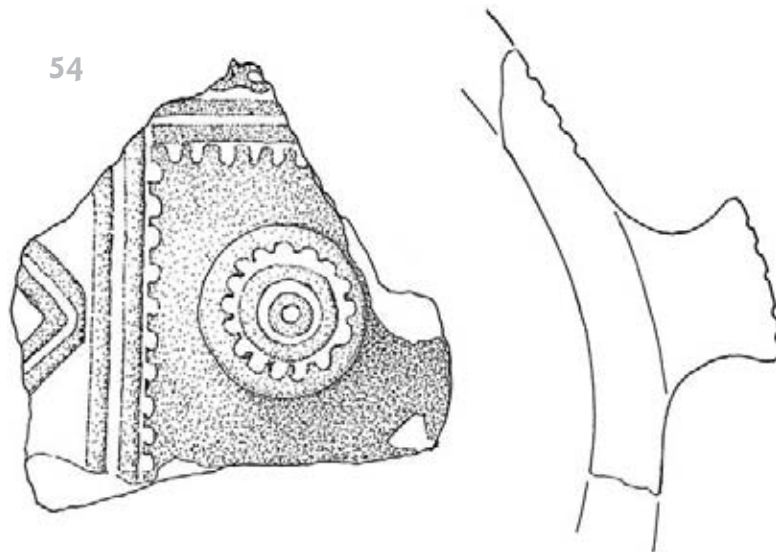

55

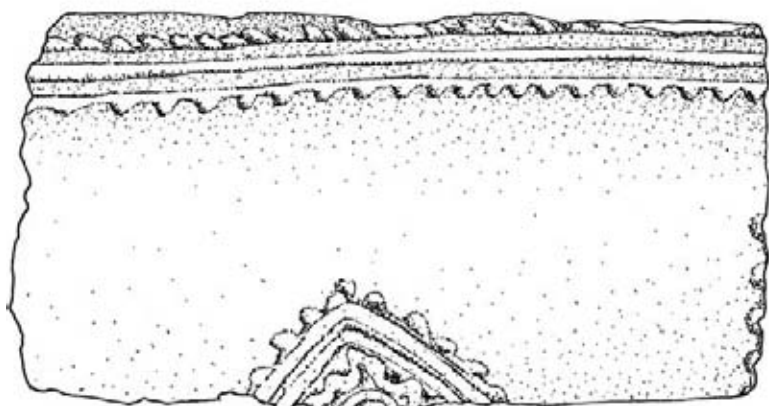

56

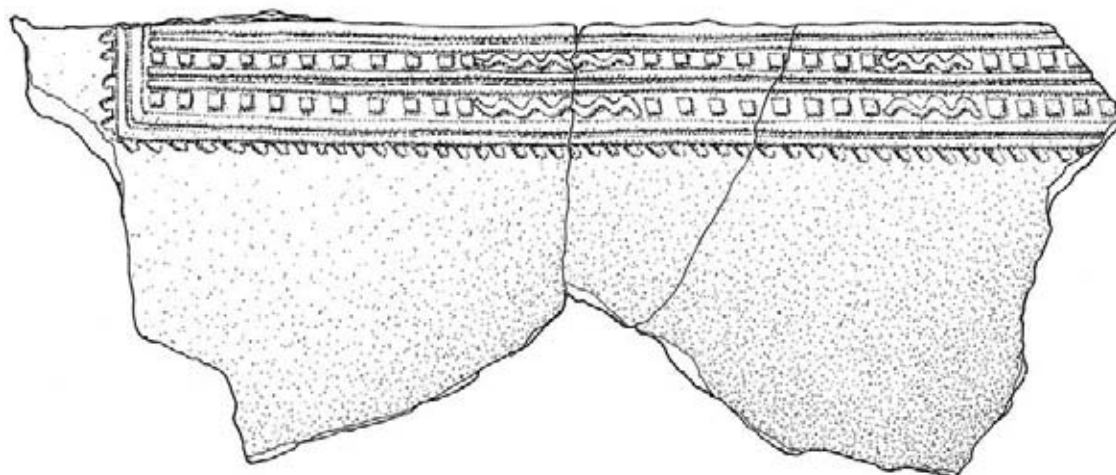

57

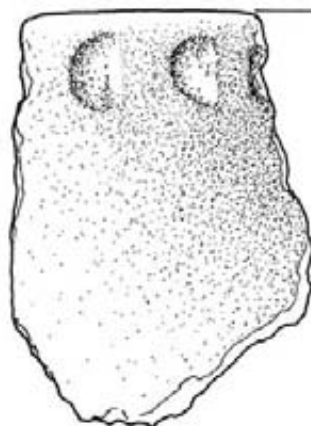

III

Tabla 16



58

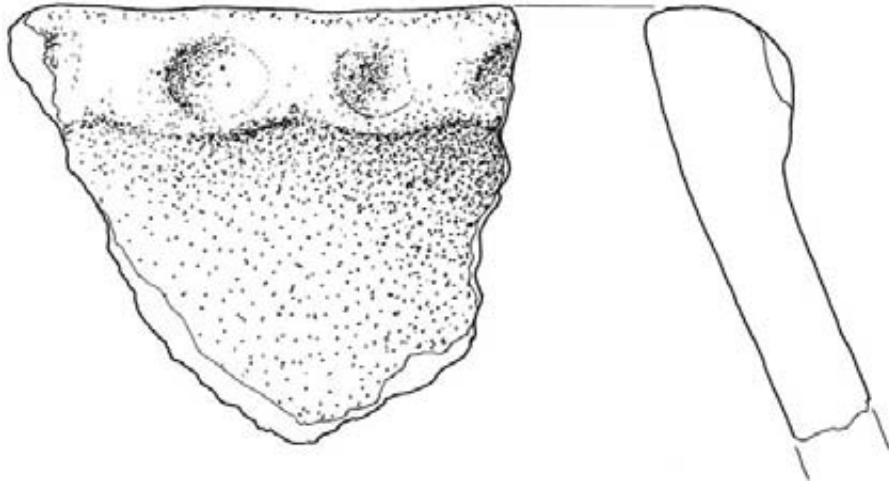

59

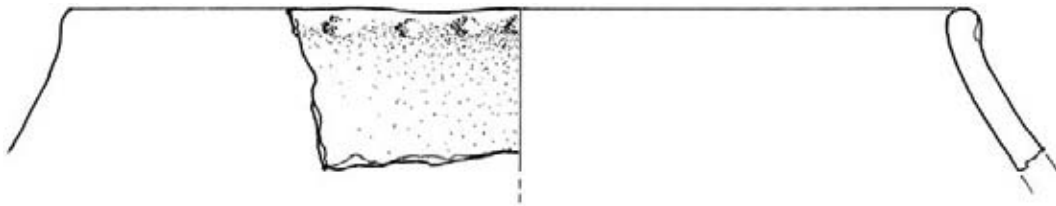

60

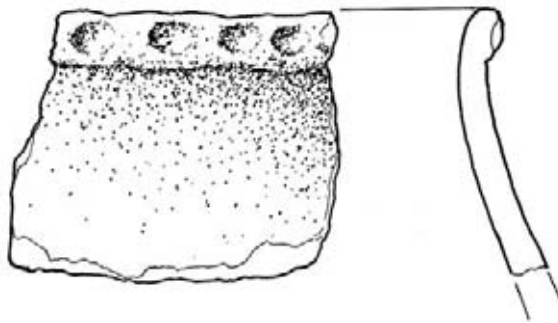

61

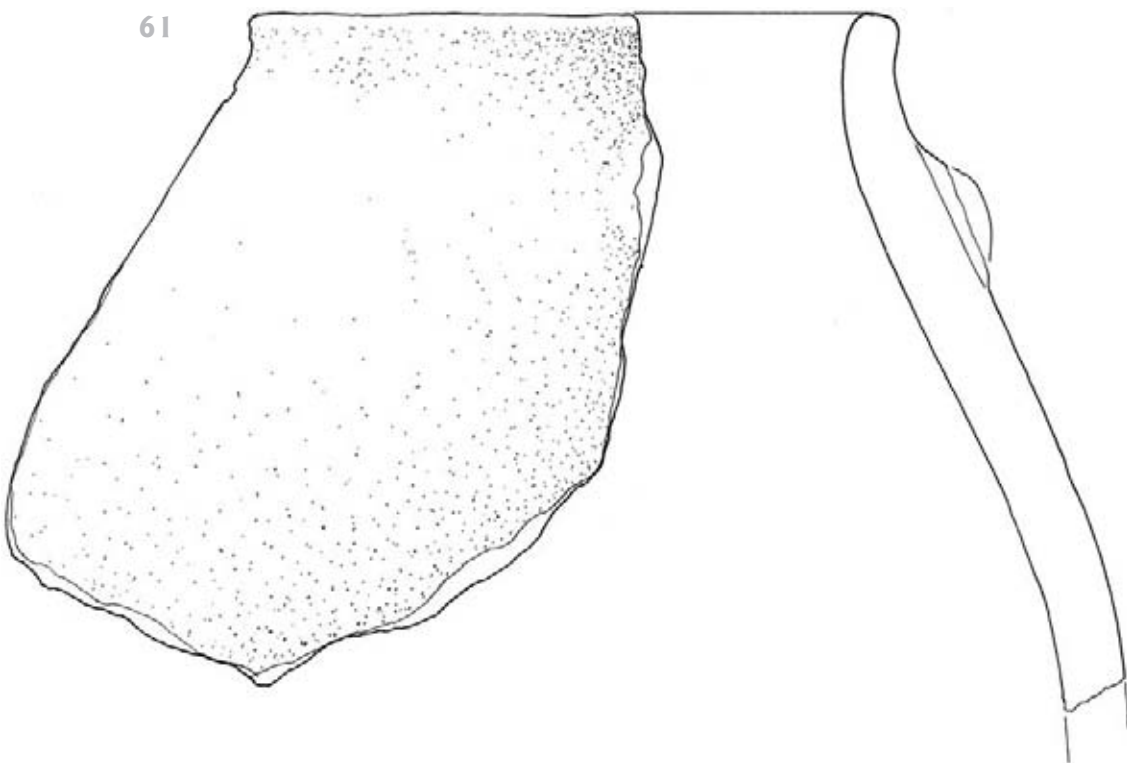

62

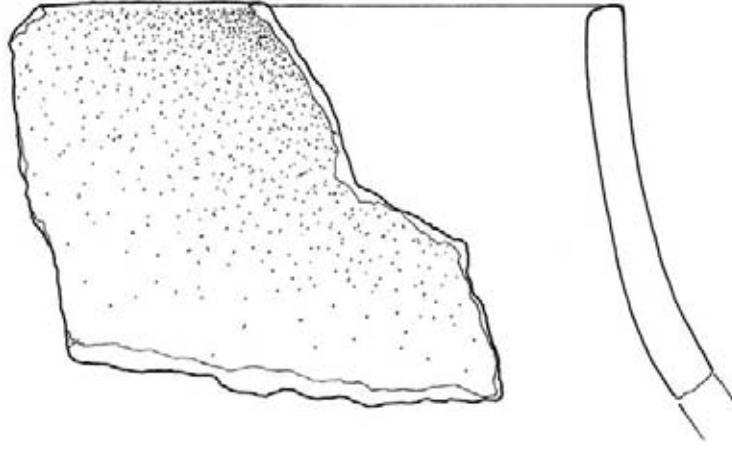

63

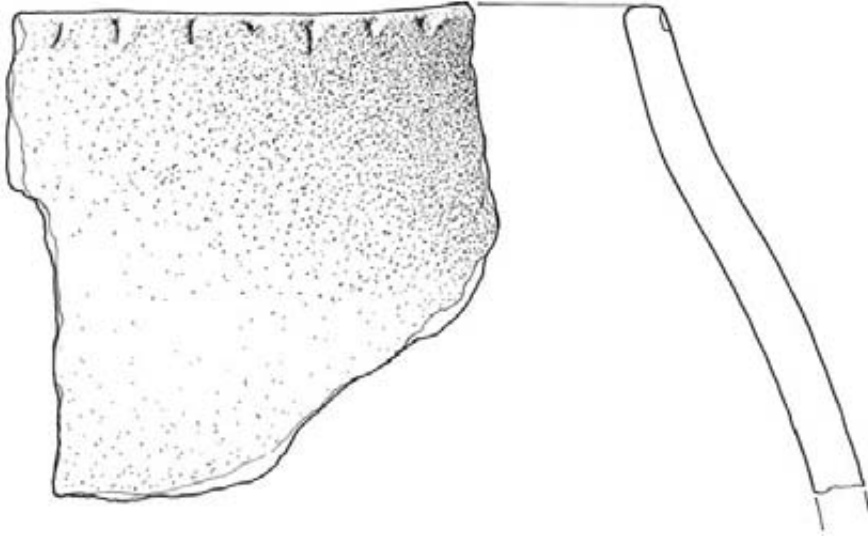

64



Tabla 18

65

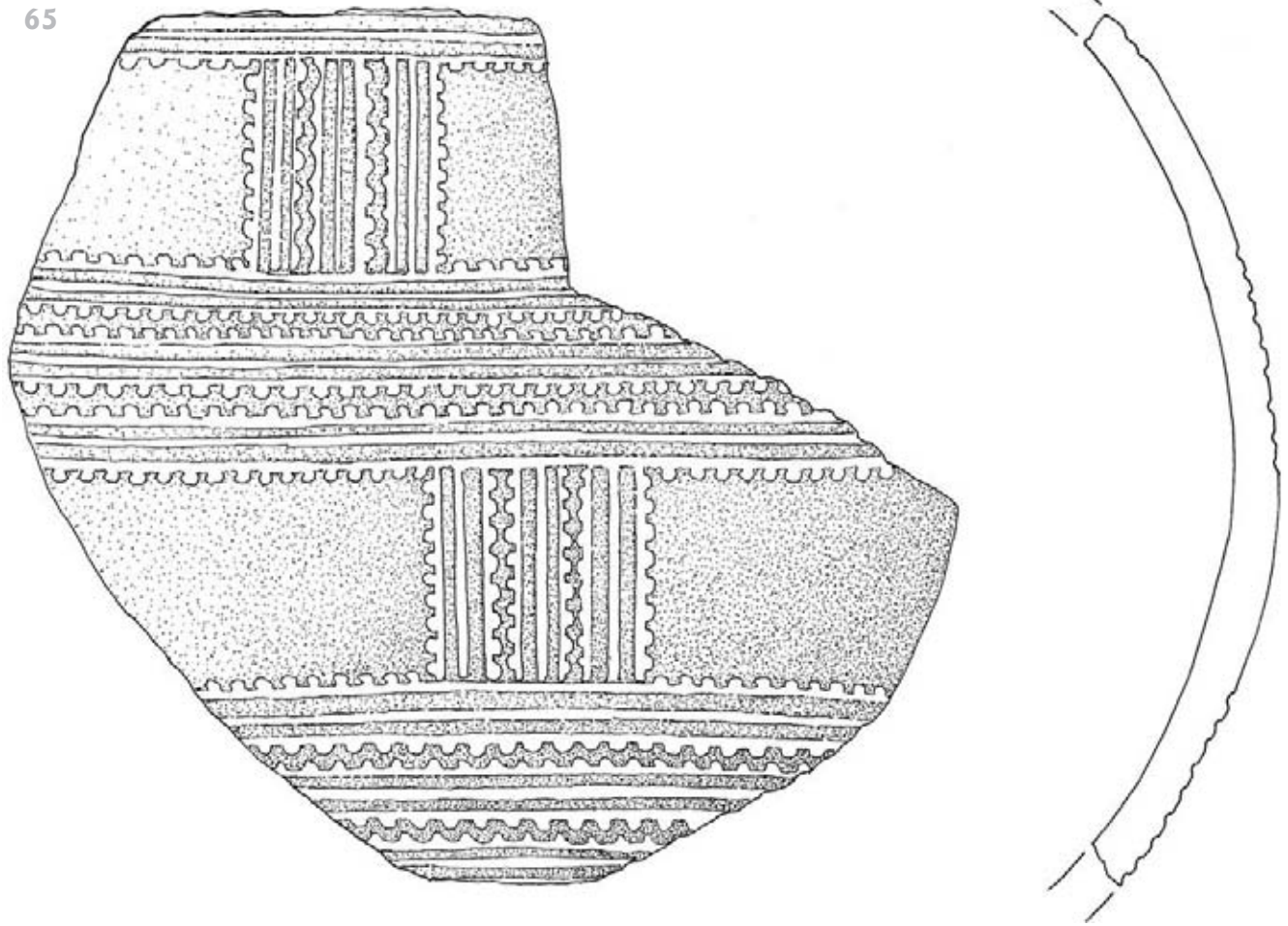

114

66

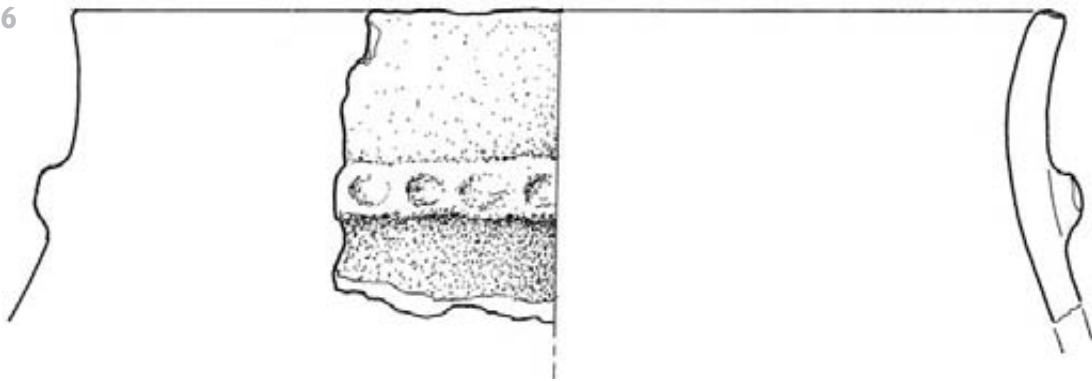

67

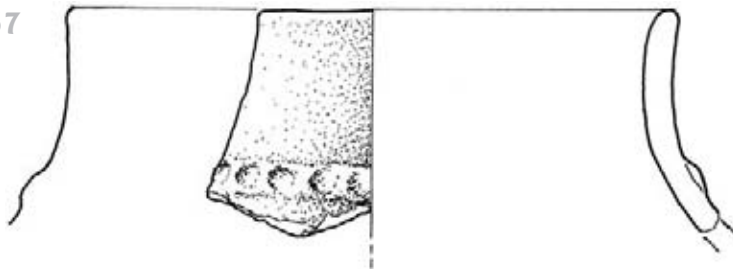

68



Tabla 19

69



70

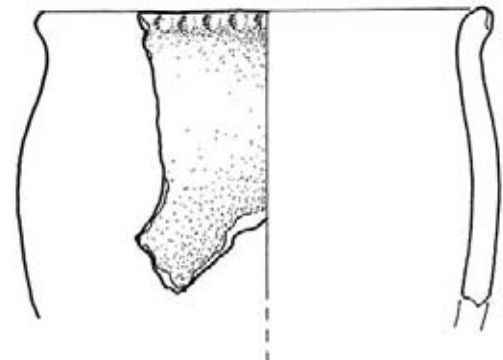
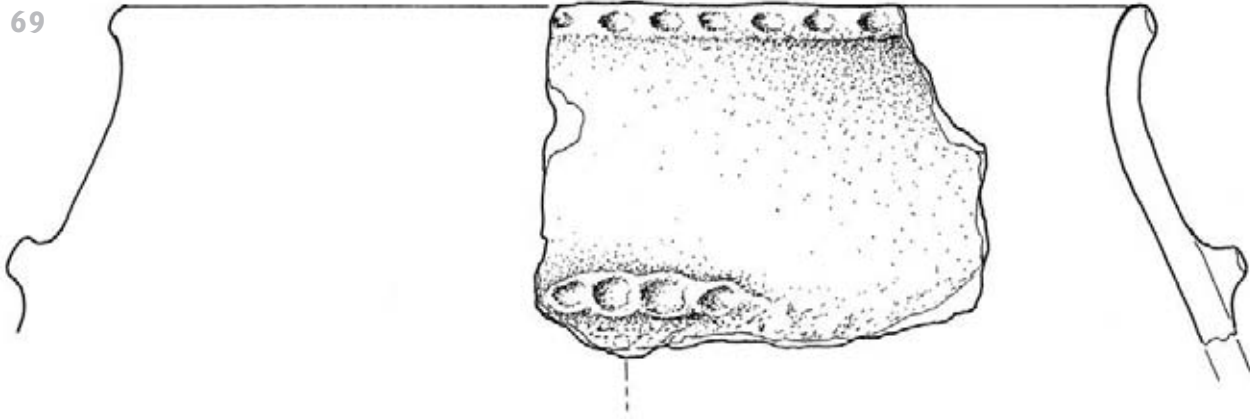
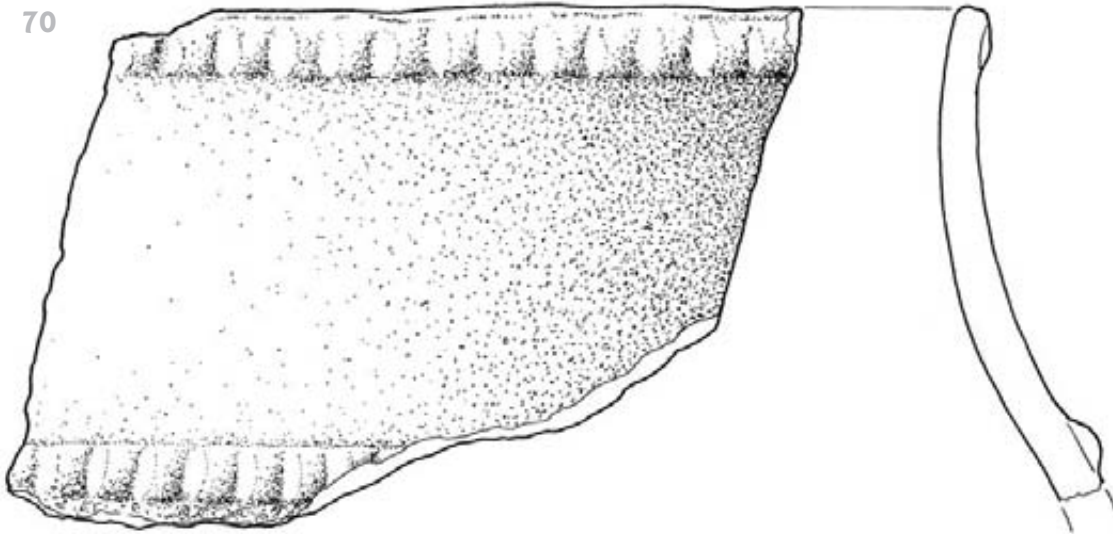

71

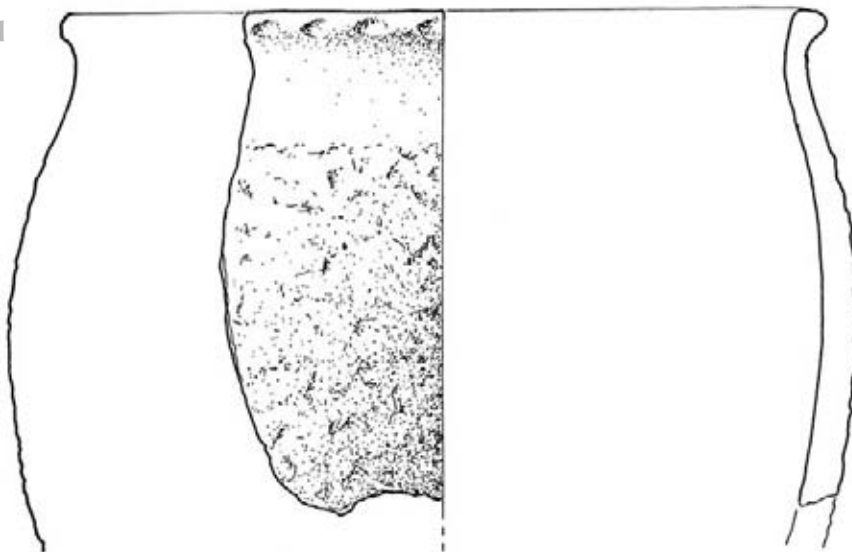

72

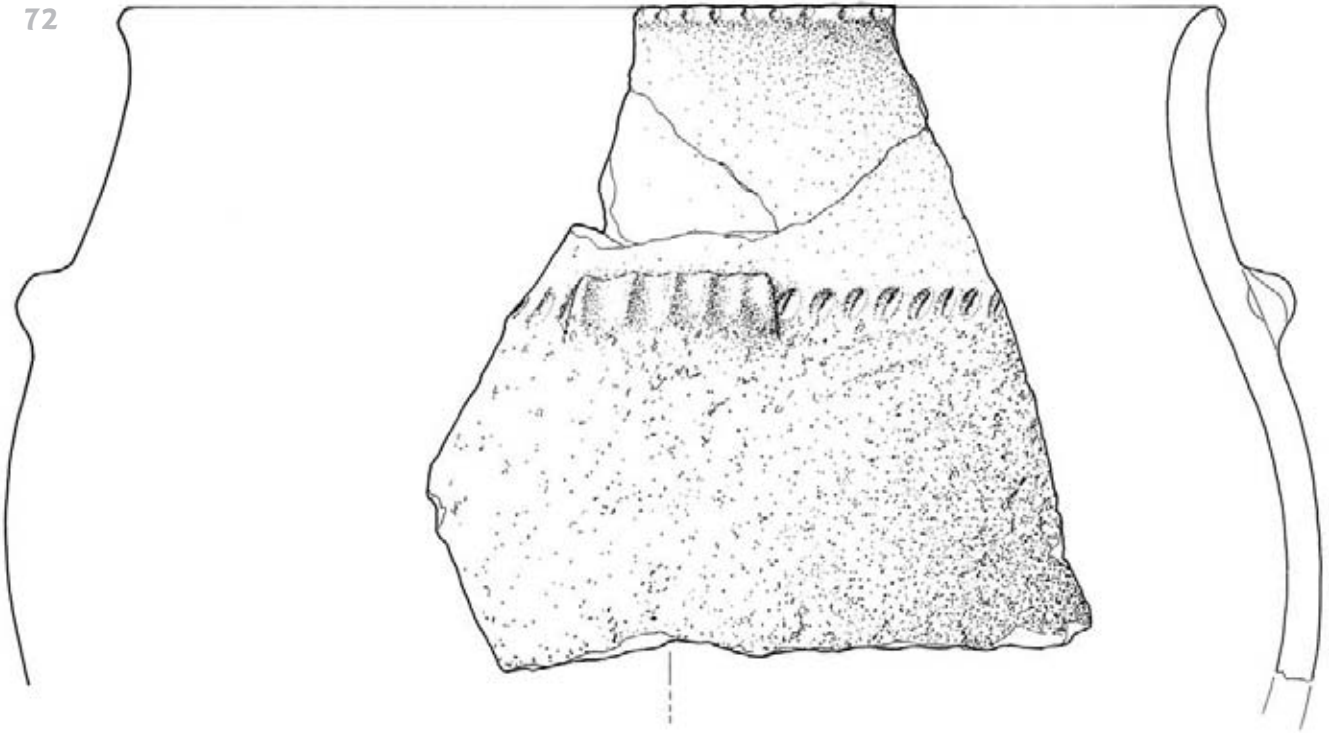

73

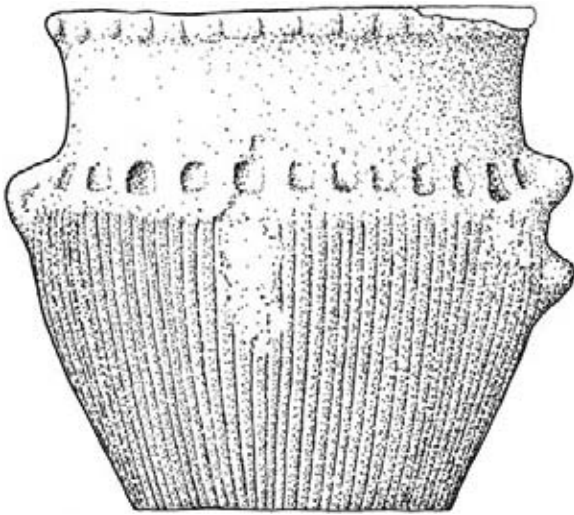

74

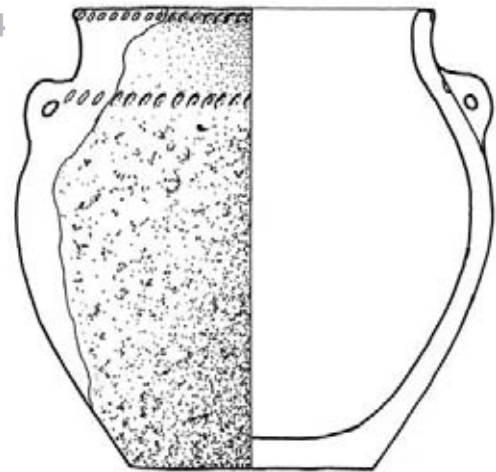

75

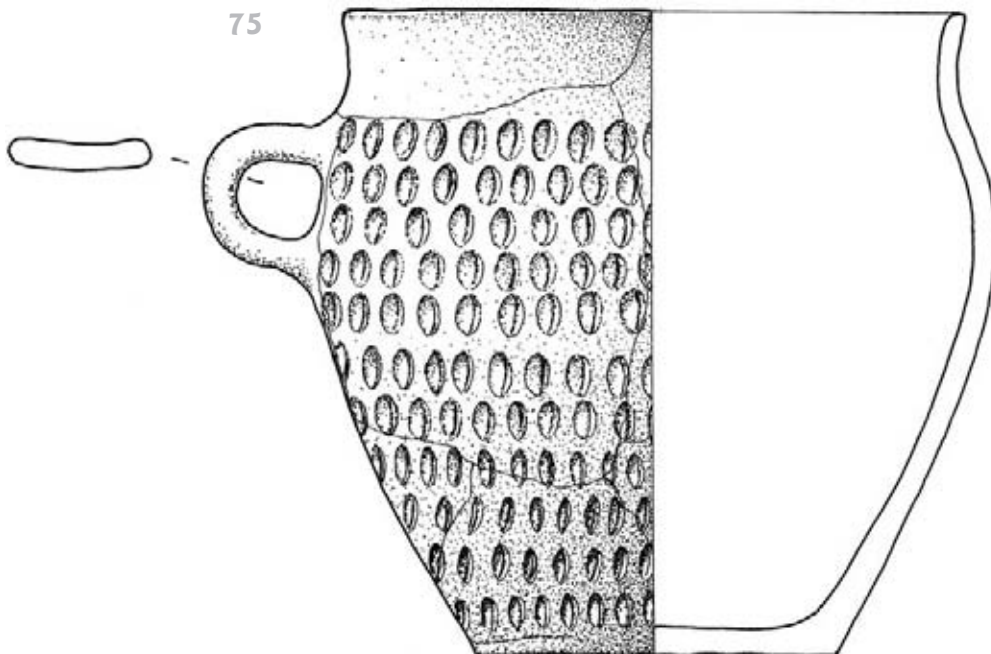

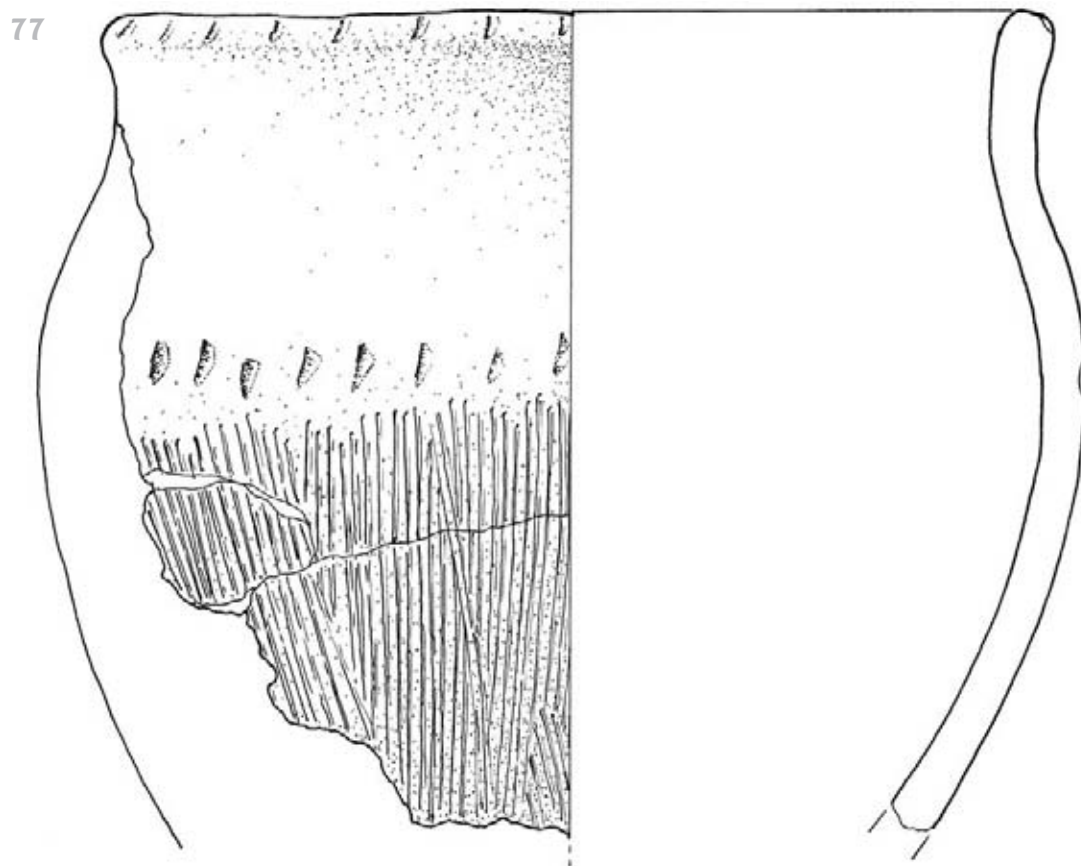
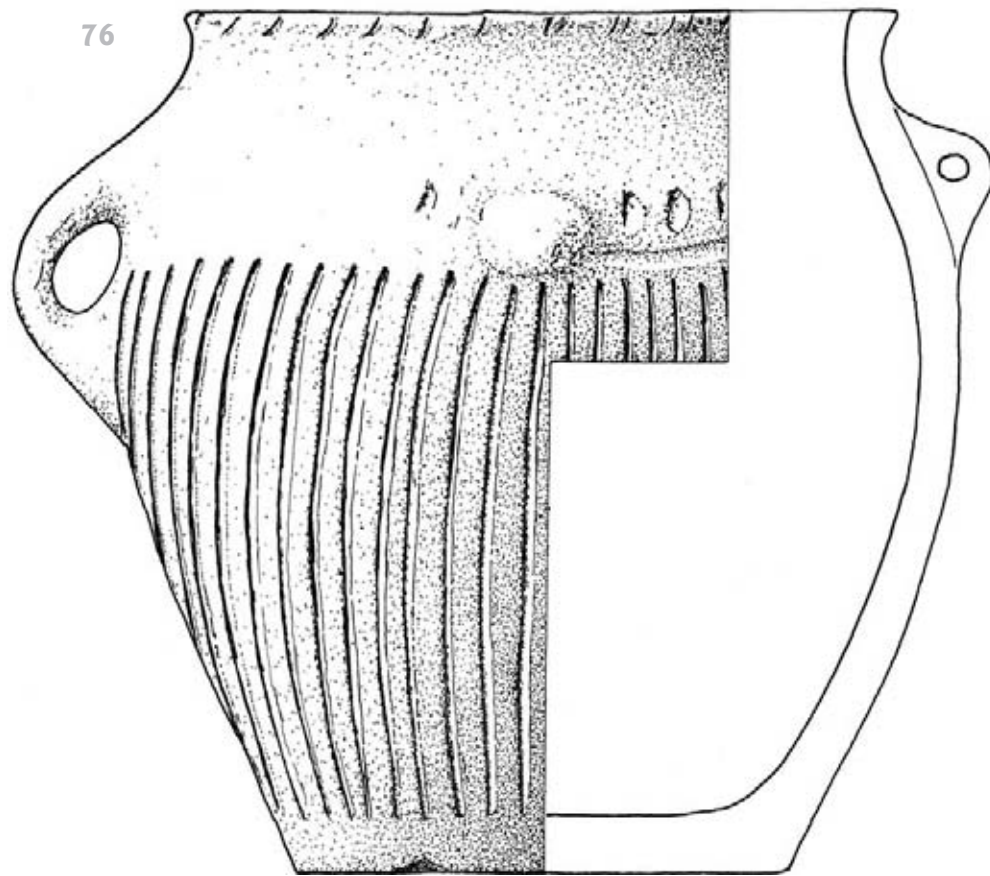



Tabla 23

81



82

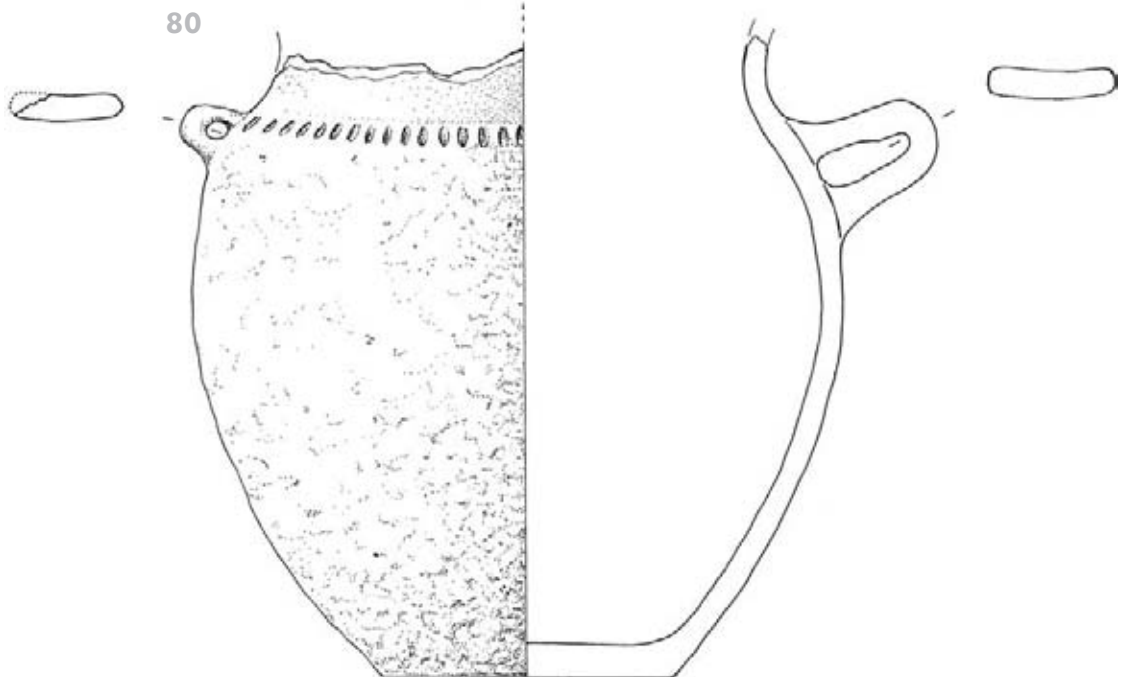
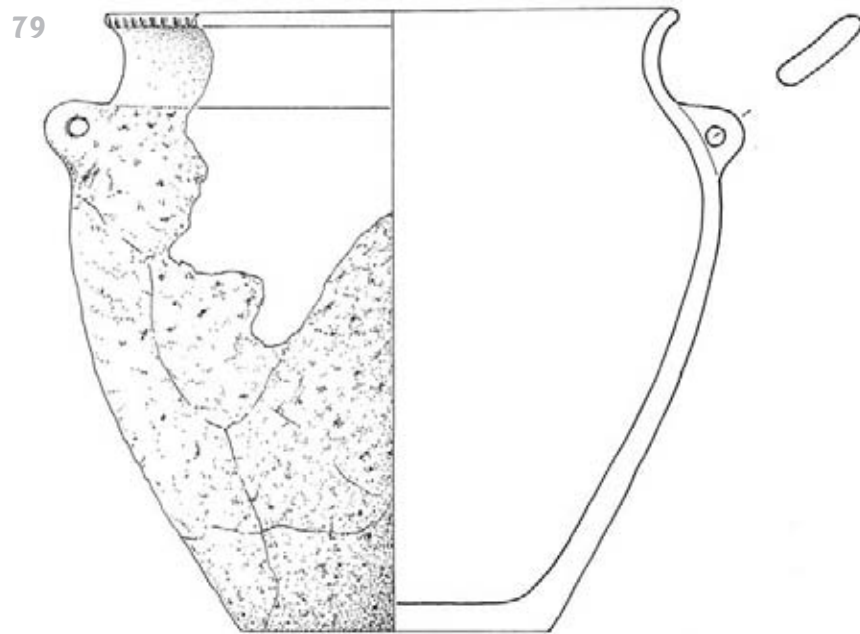
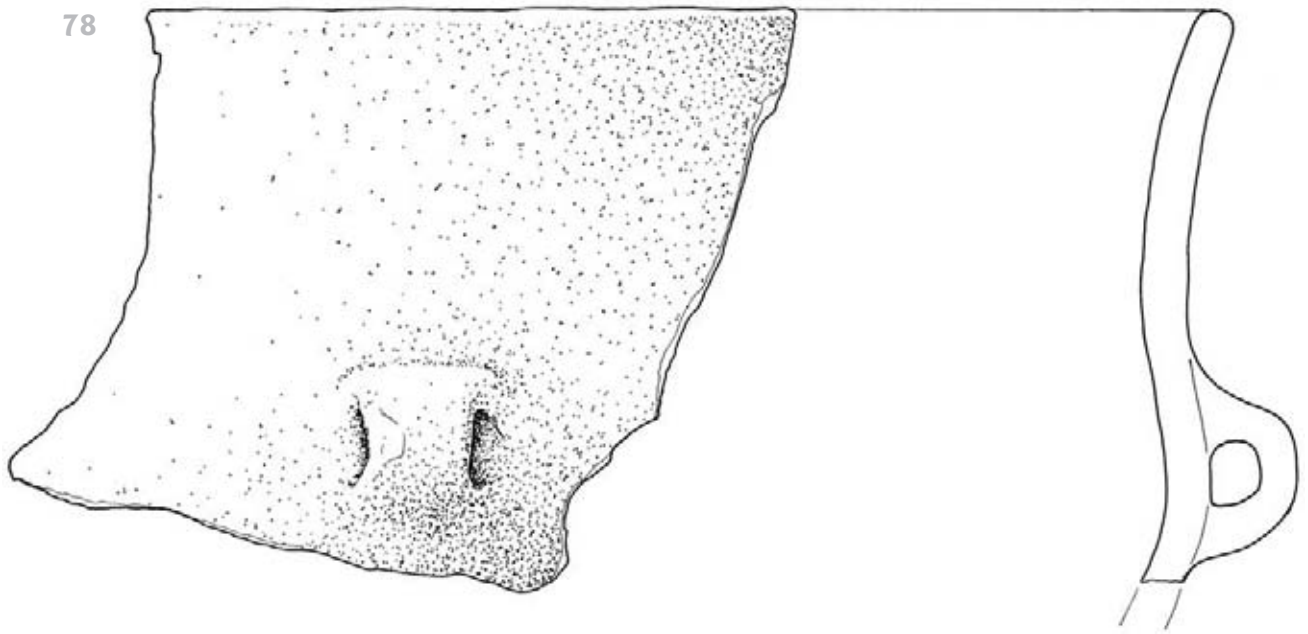
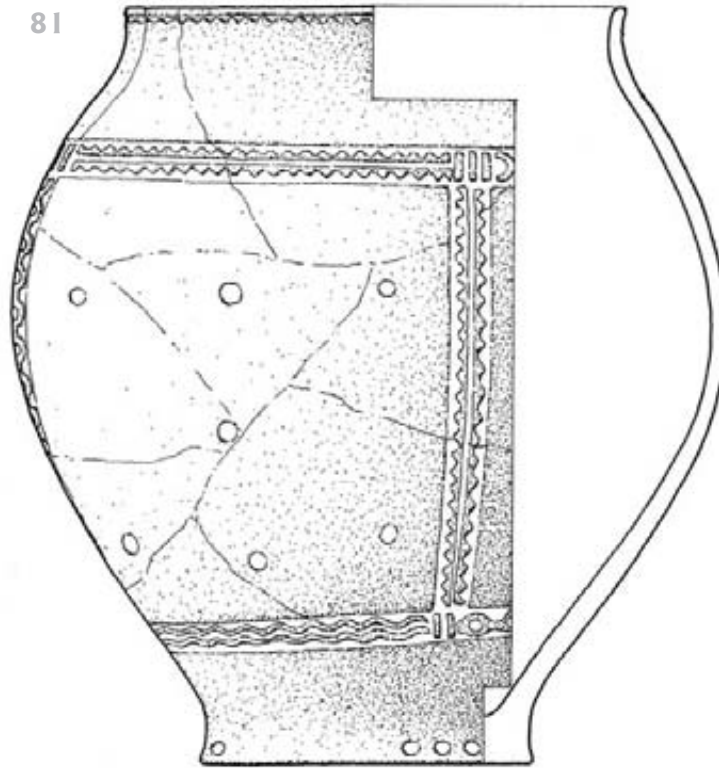
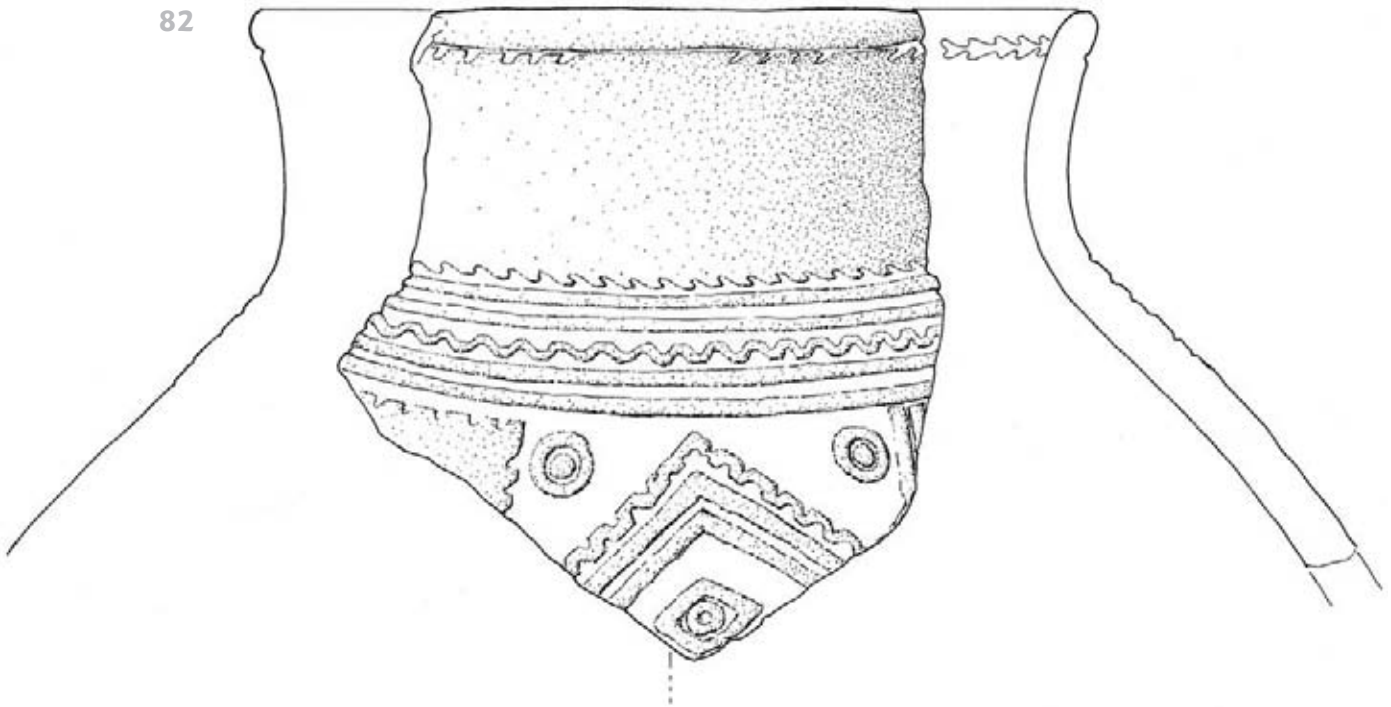

83



Tabla 24



84

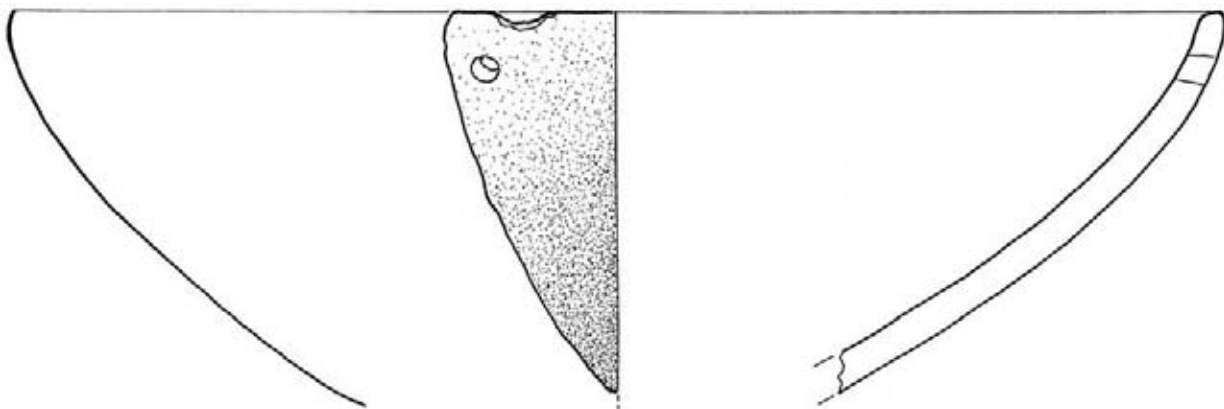
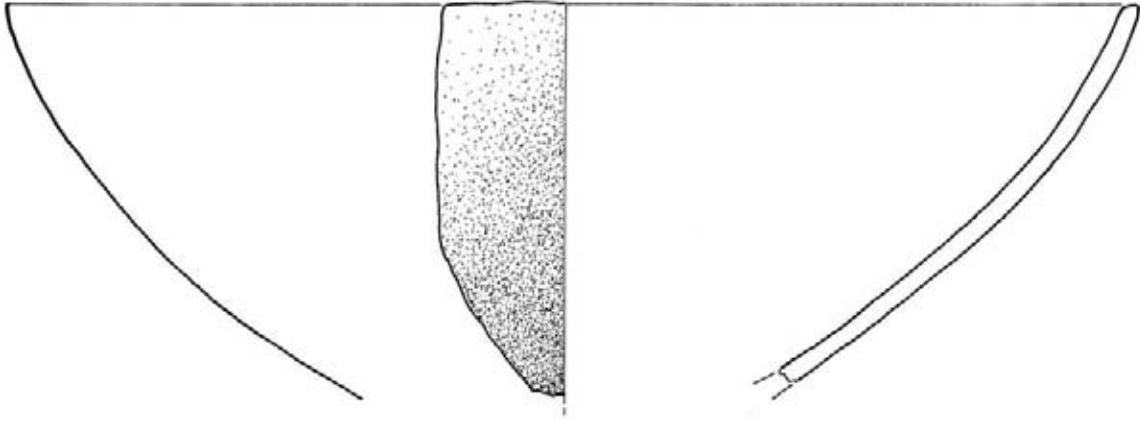

85

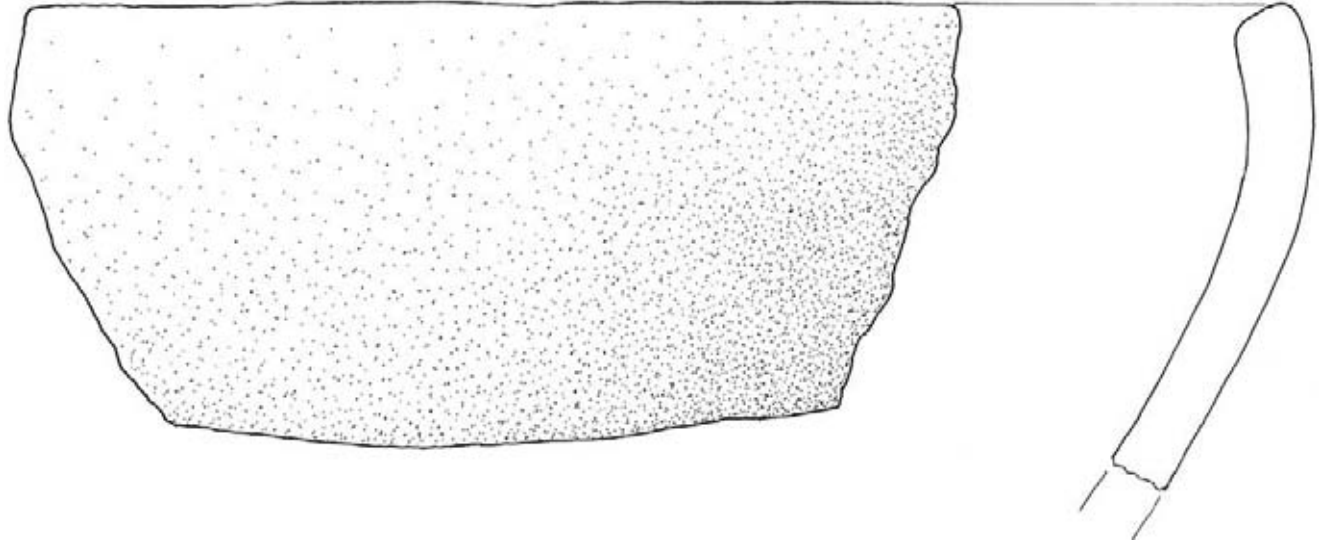

86

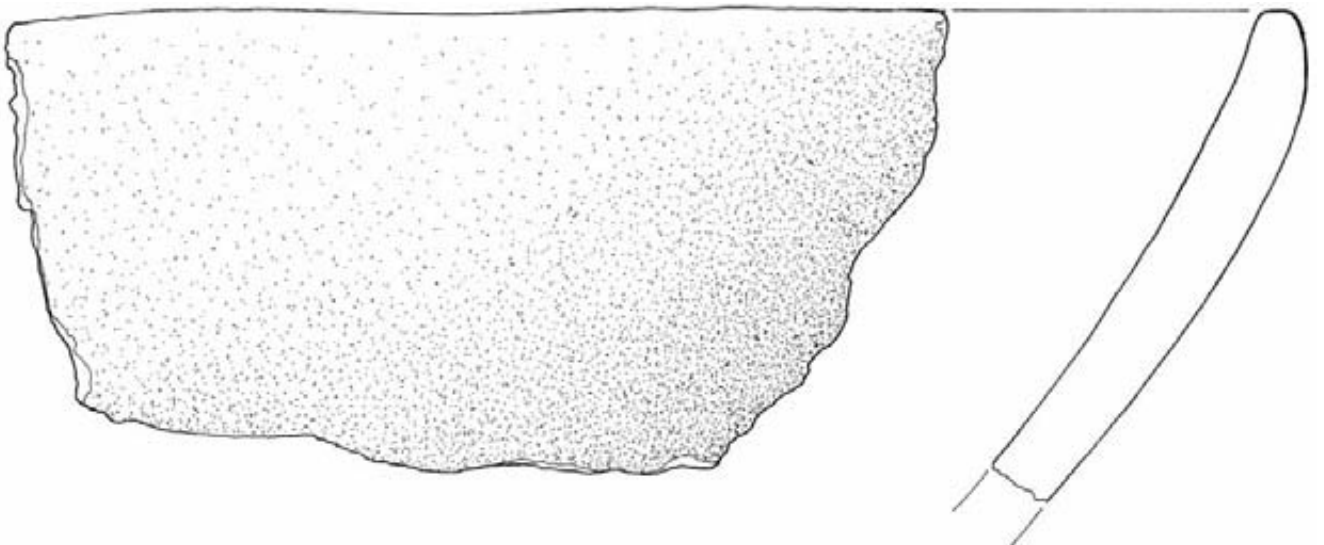

87

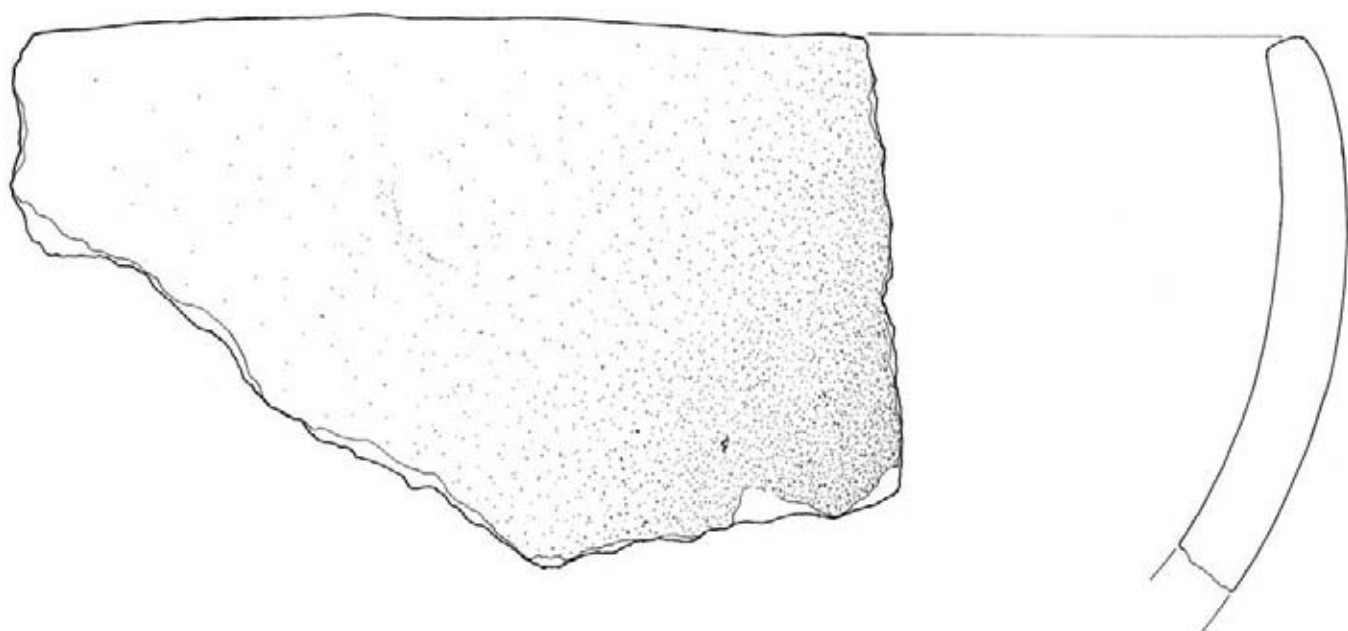

88

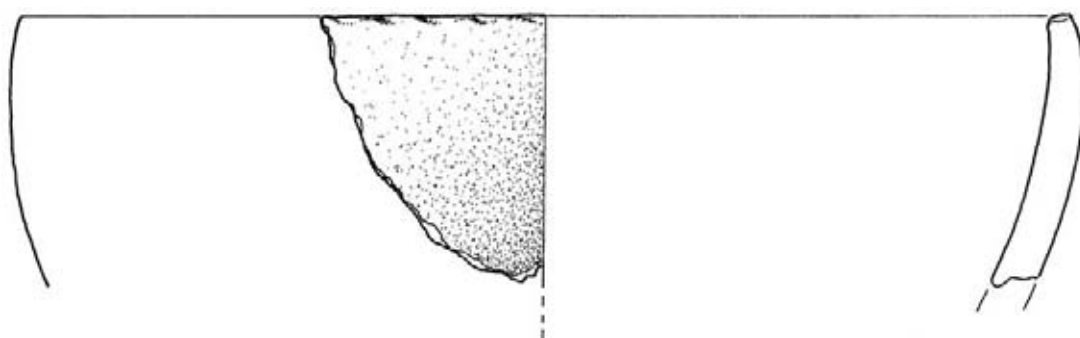

89

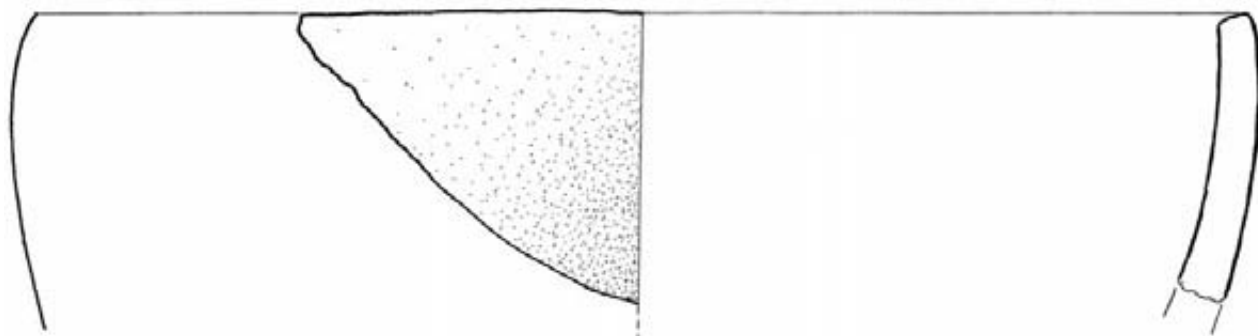

90

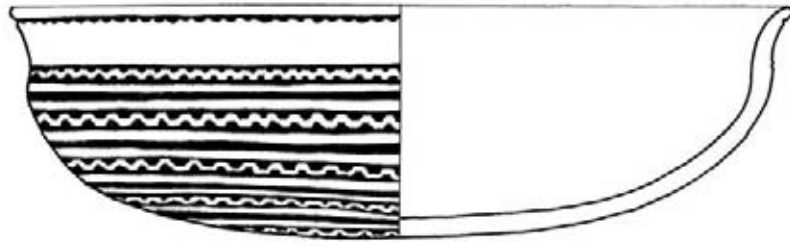

91

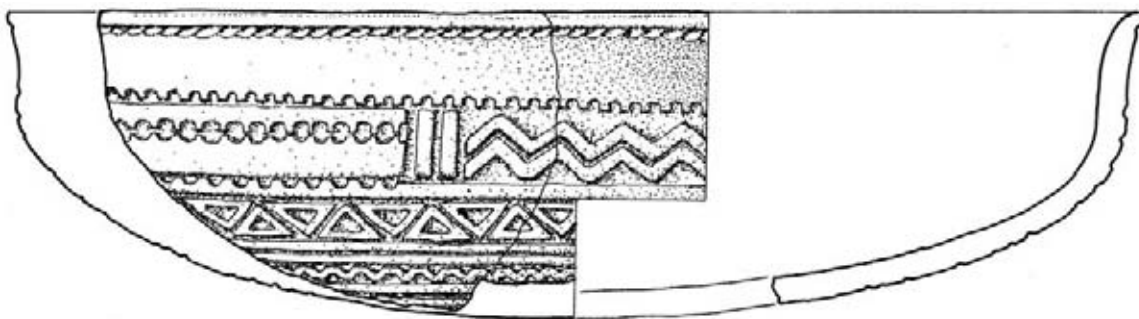

92



Tabla 27

93



94

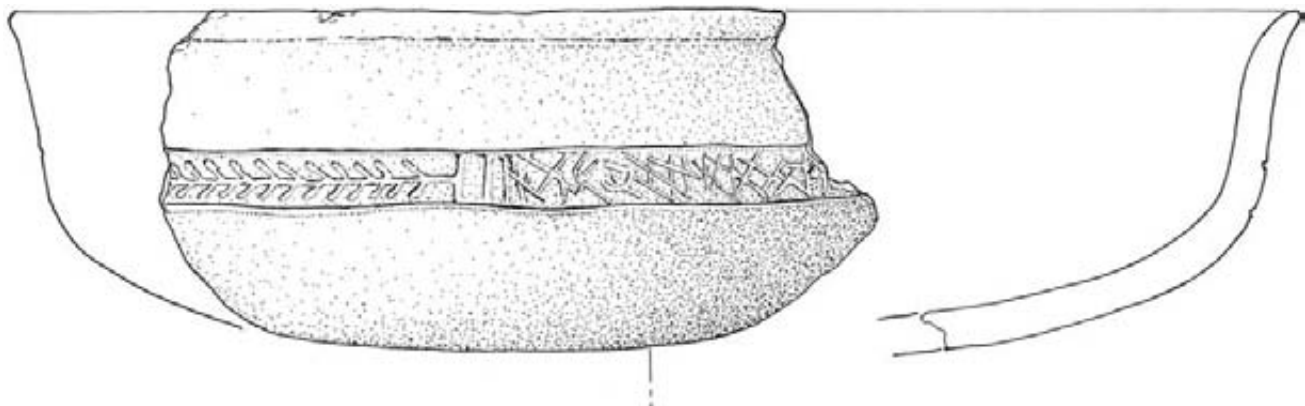
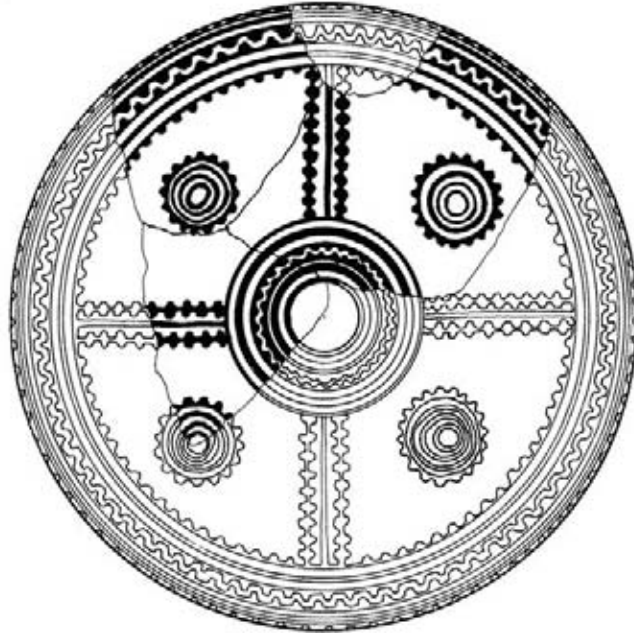
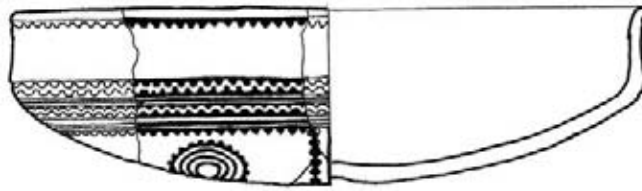

Tabla 28

95



96

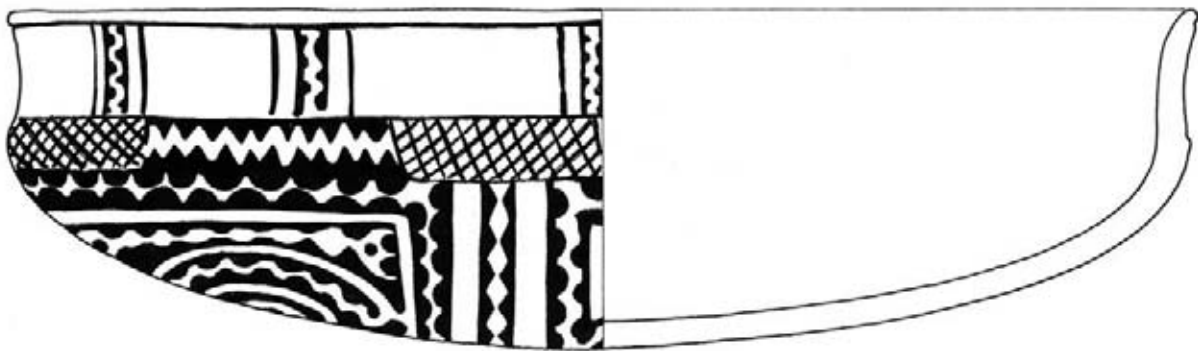
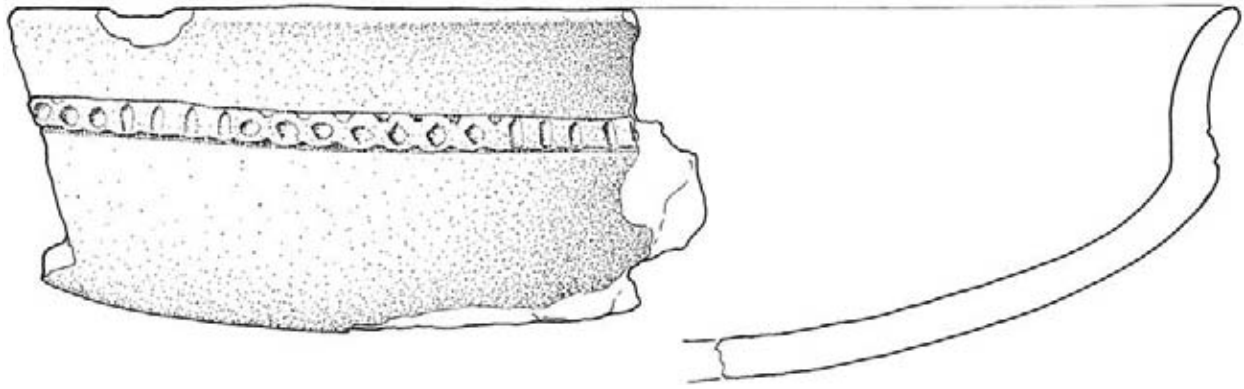
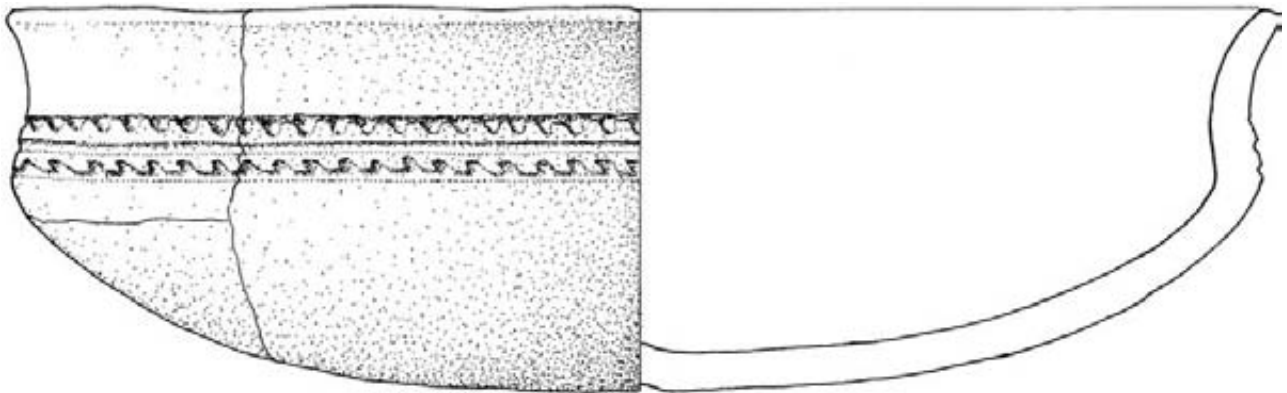

97

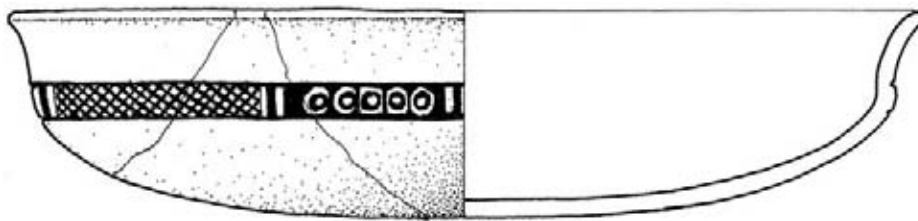

100

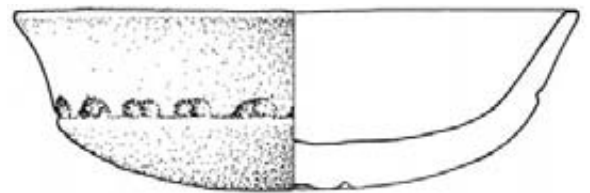

98

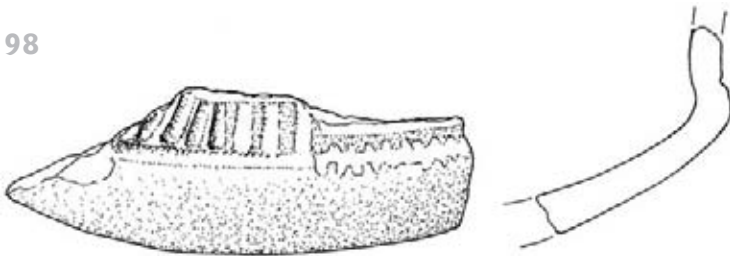

99



Tabla 29



Tabla 30

110

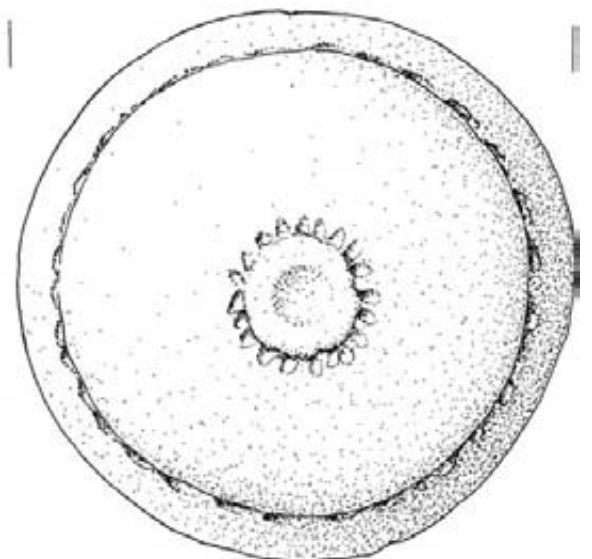
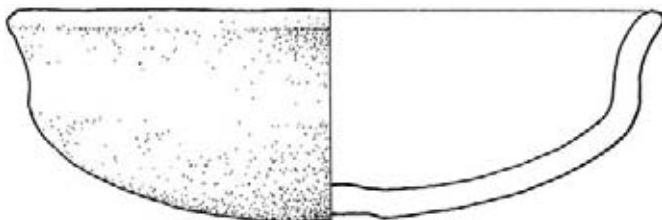

111

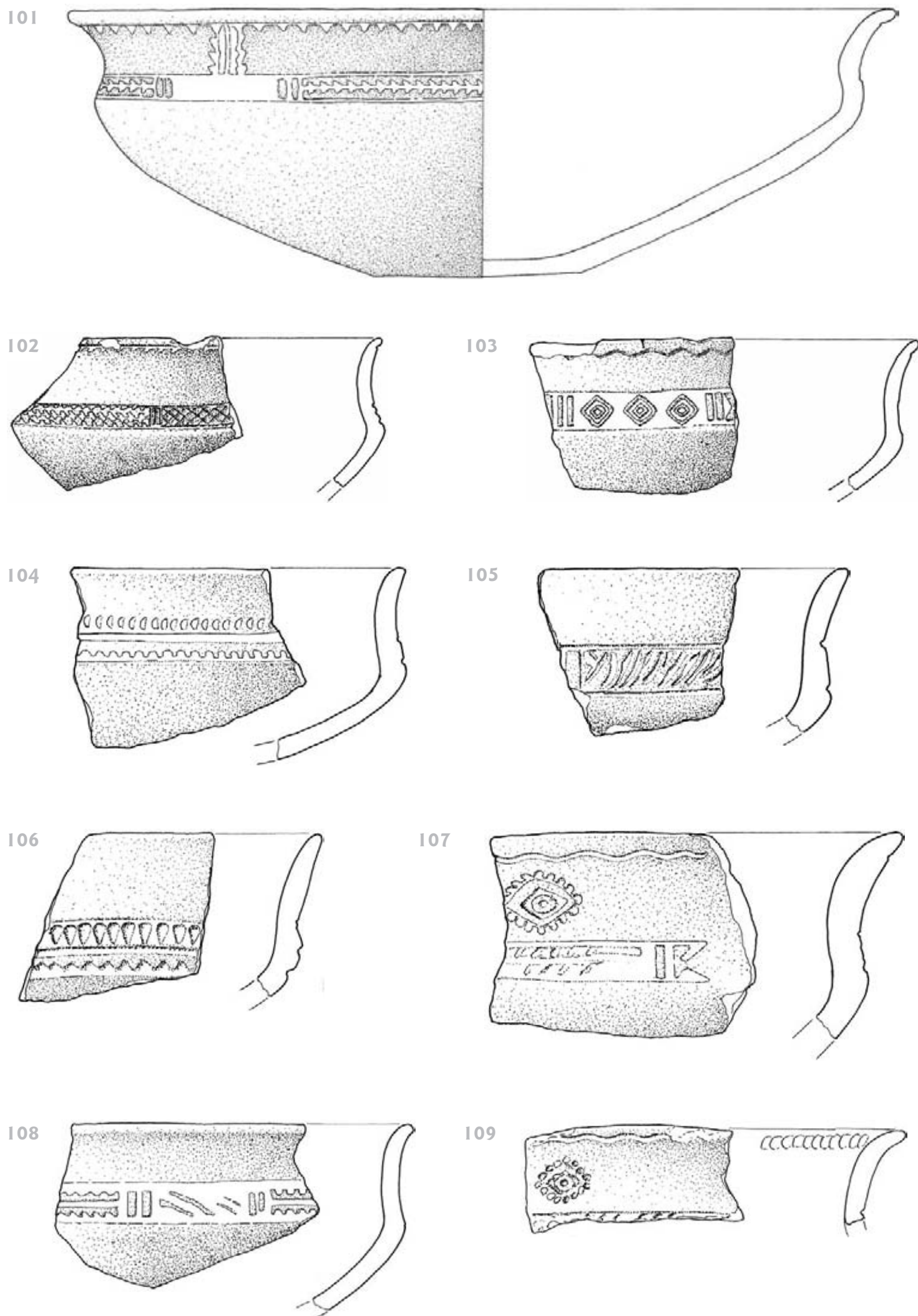
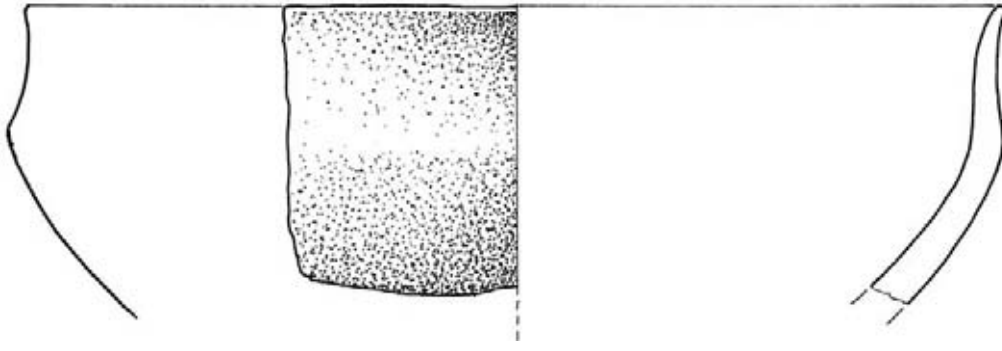
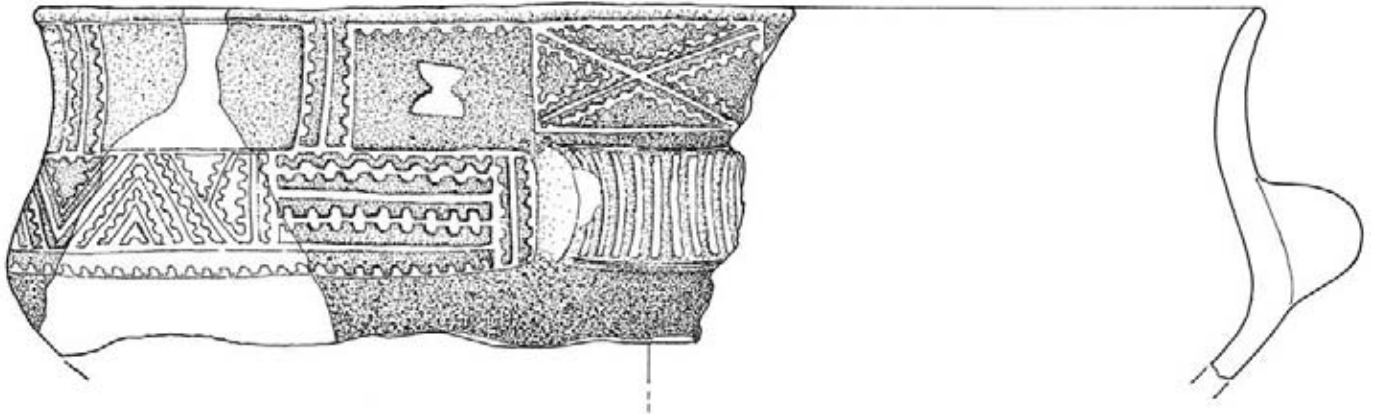

126

112

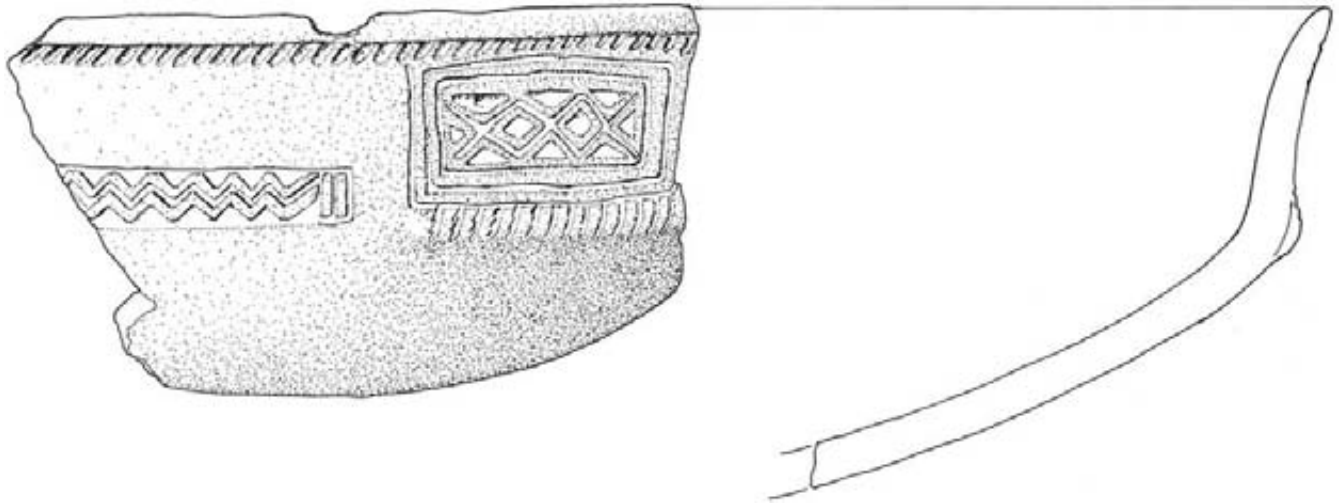

113



Tabla 31

114



115

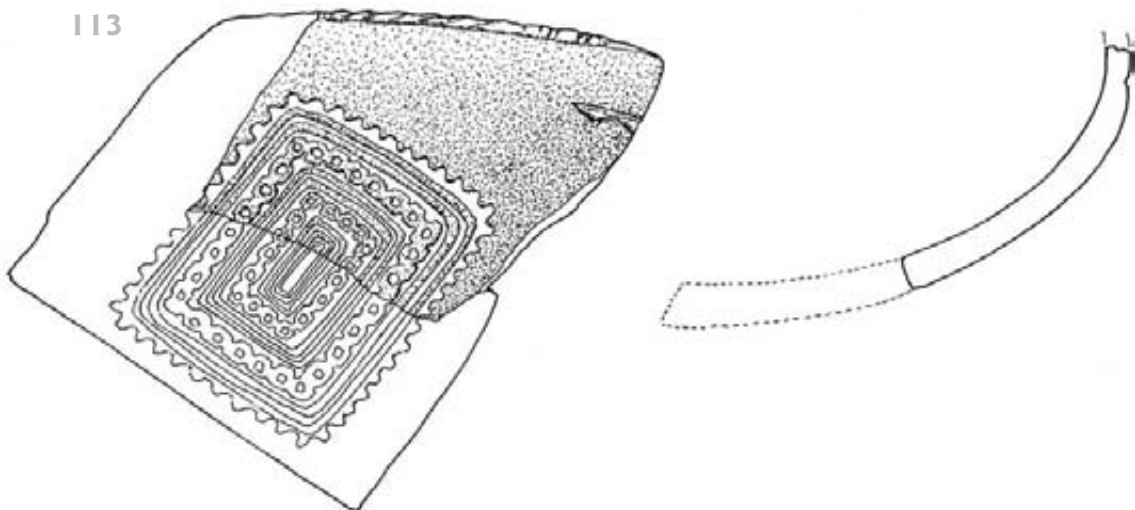
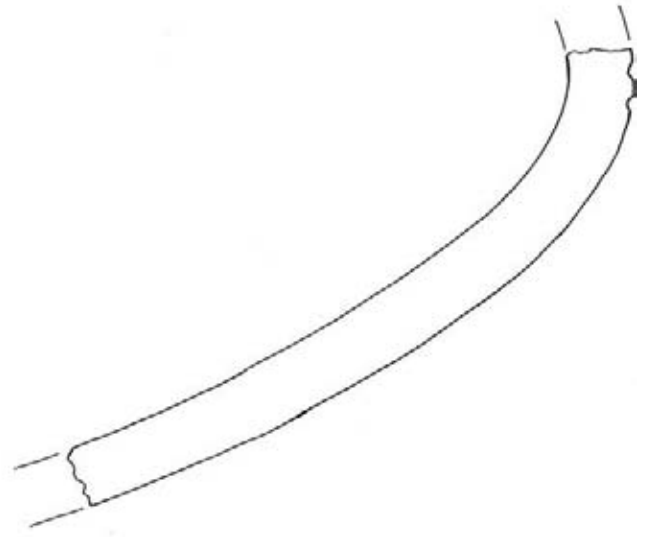
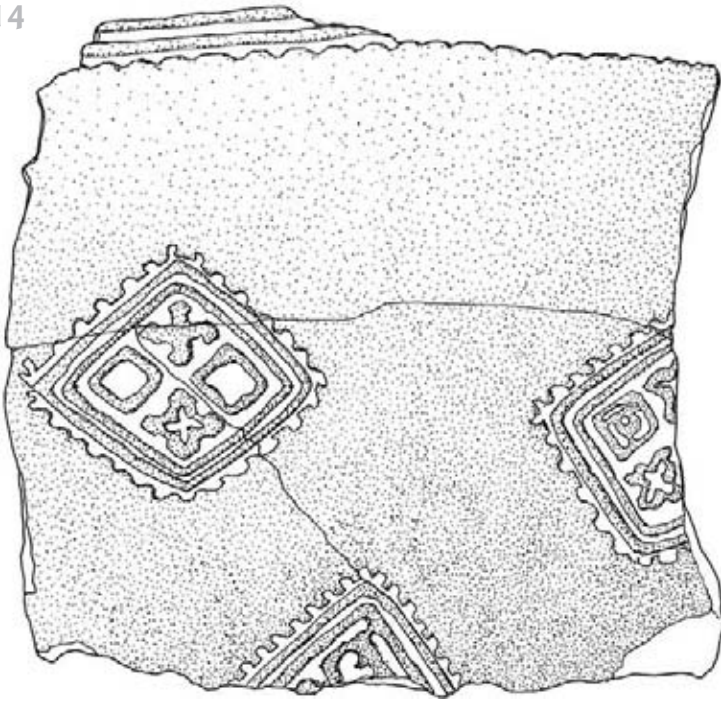
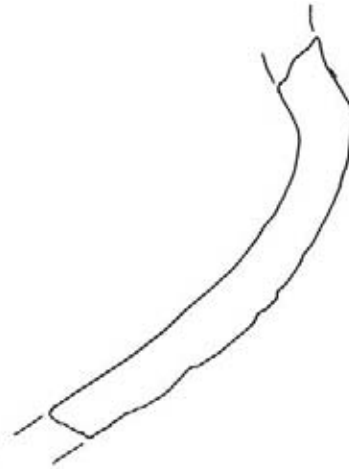
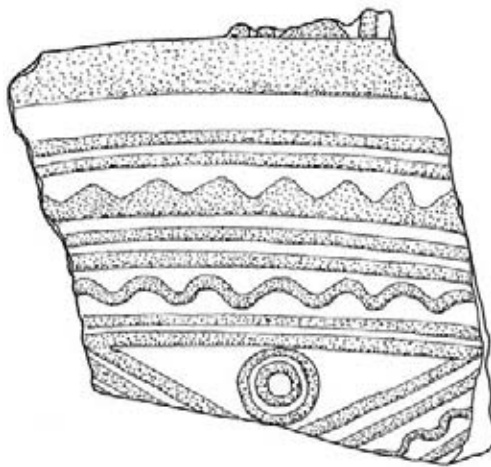

116



Tabla 32





120

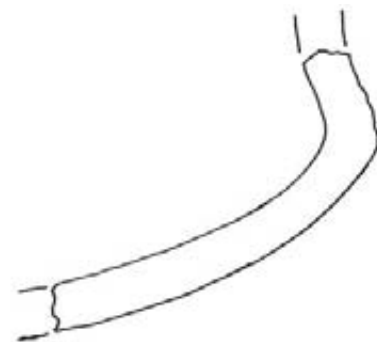
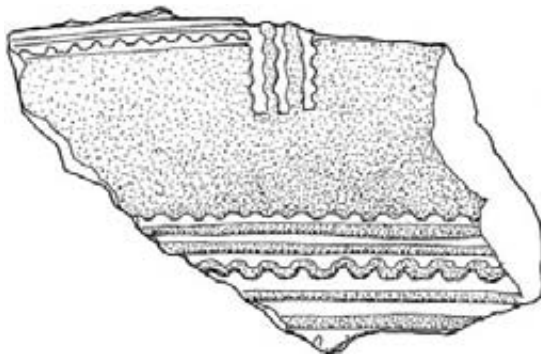
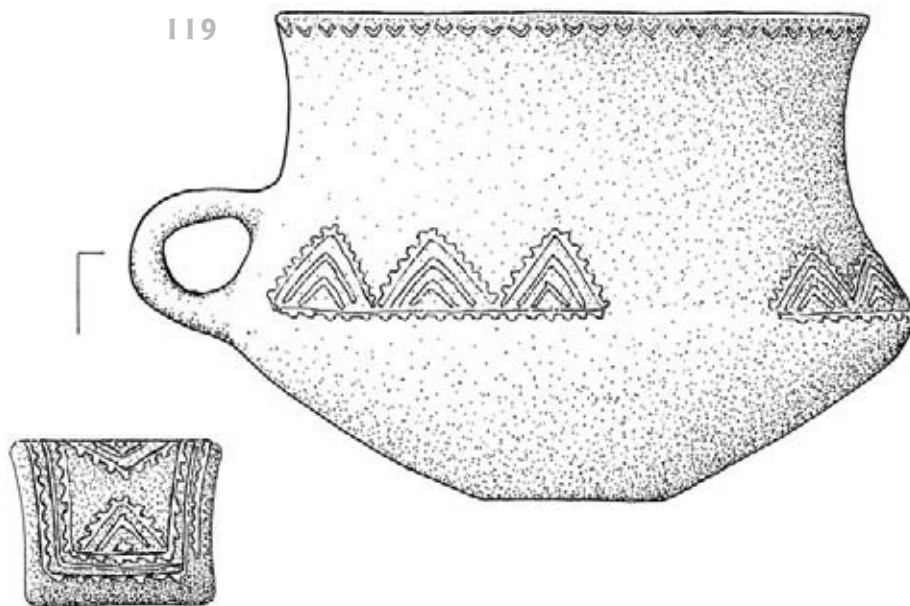
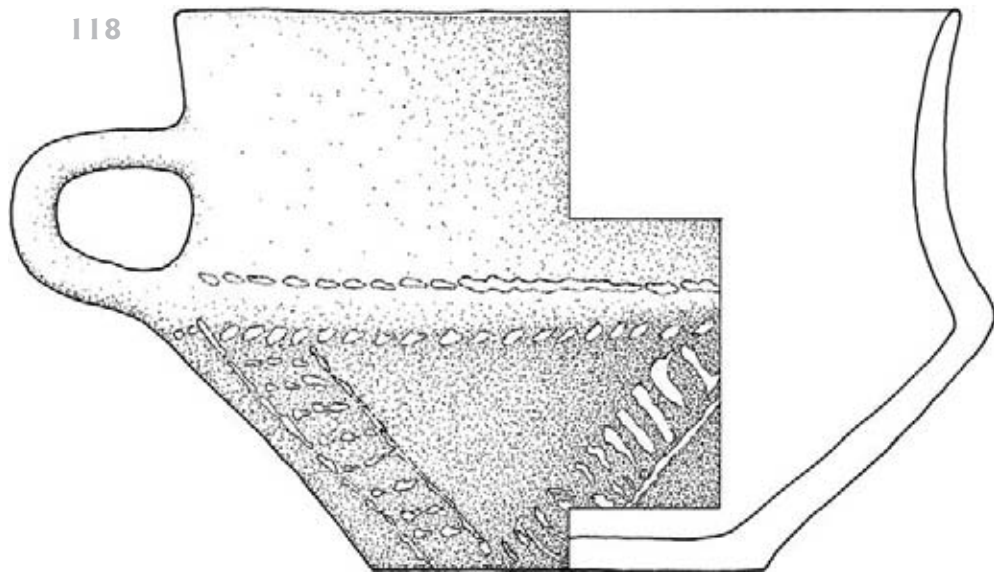
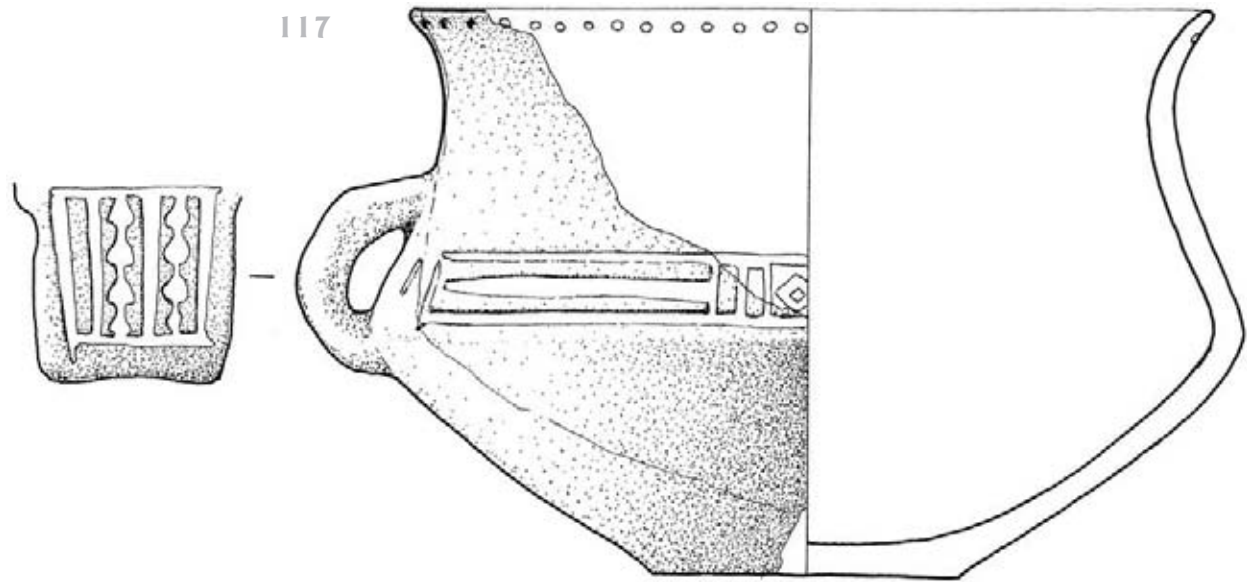
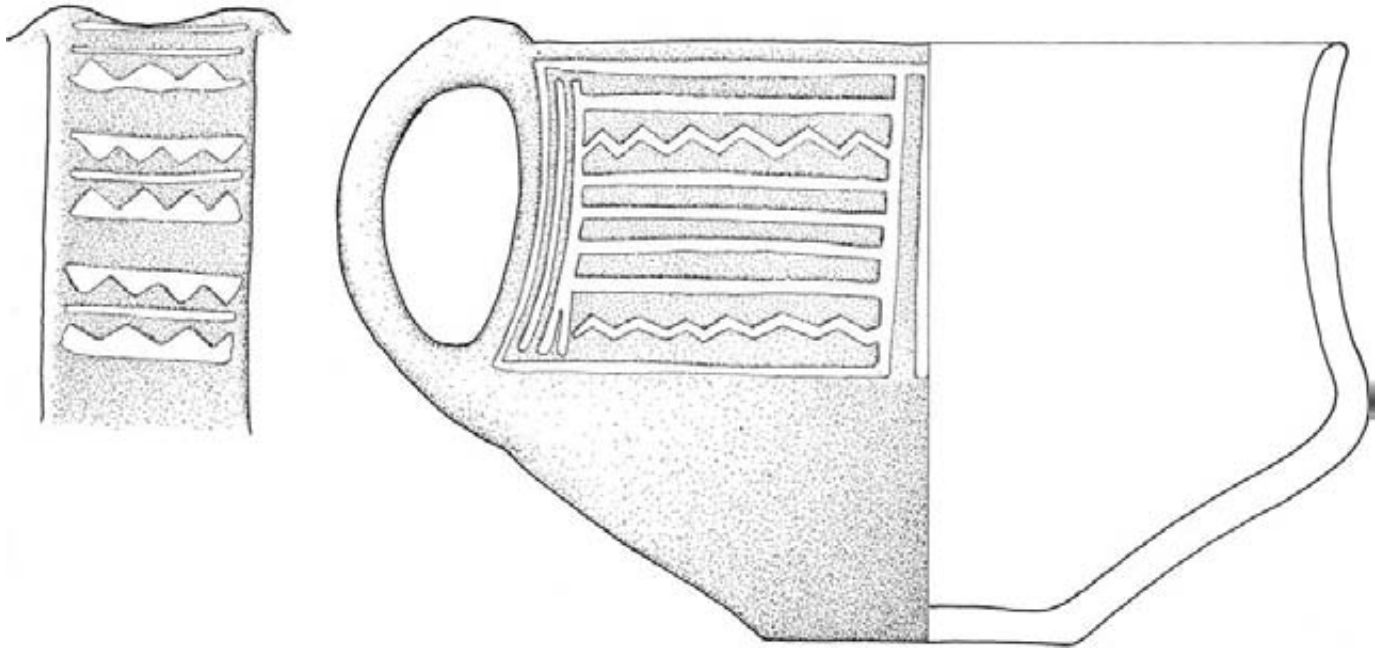

121

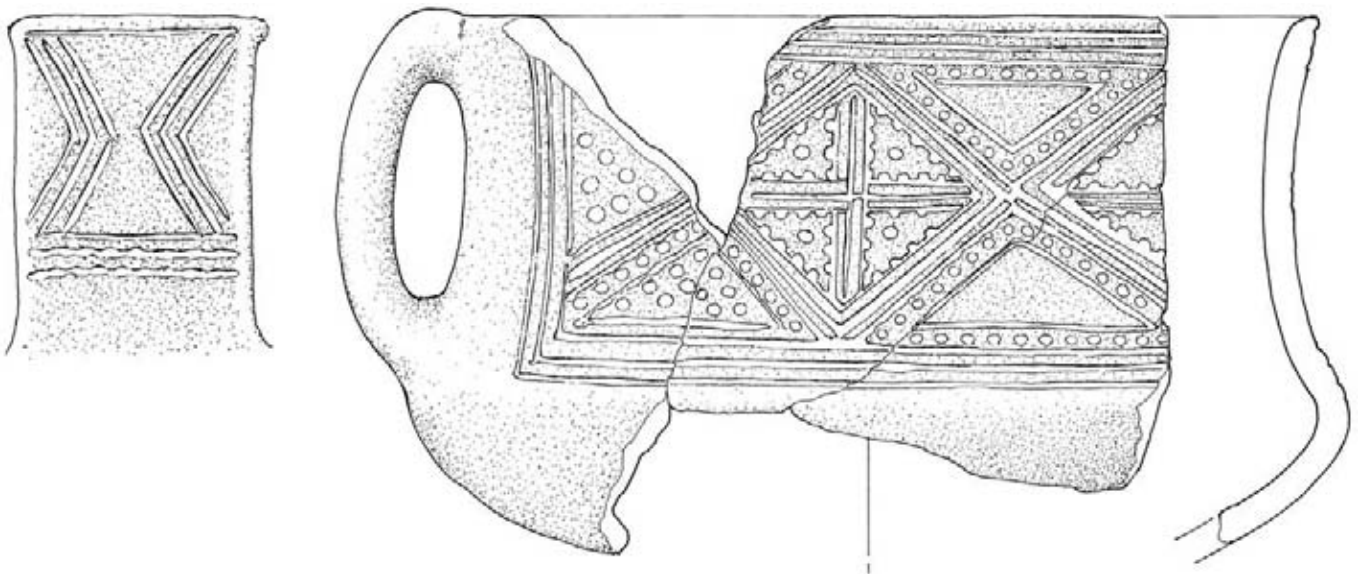

129

122



Tabla 34

123



124

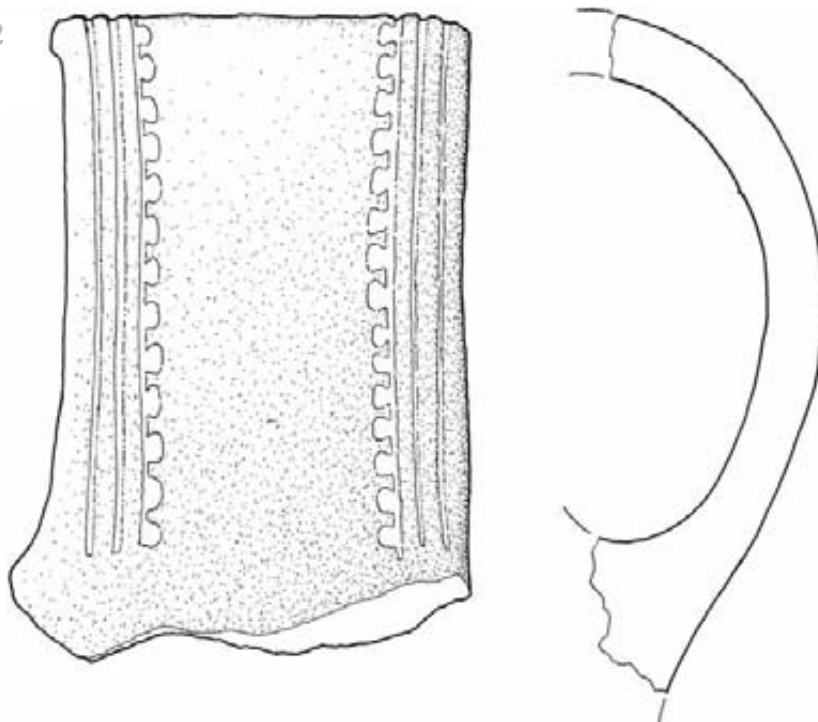
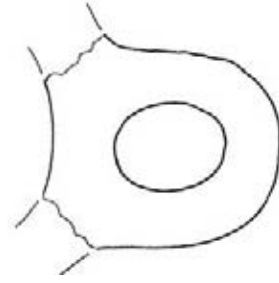
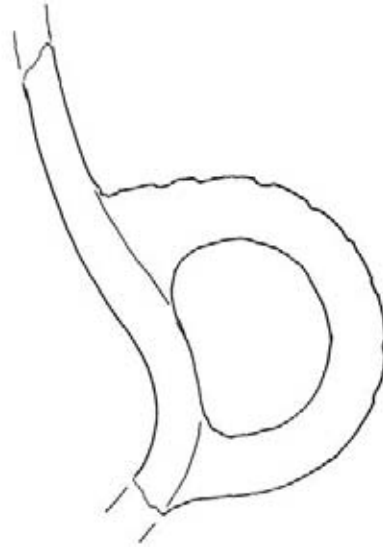
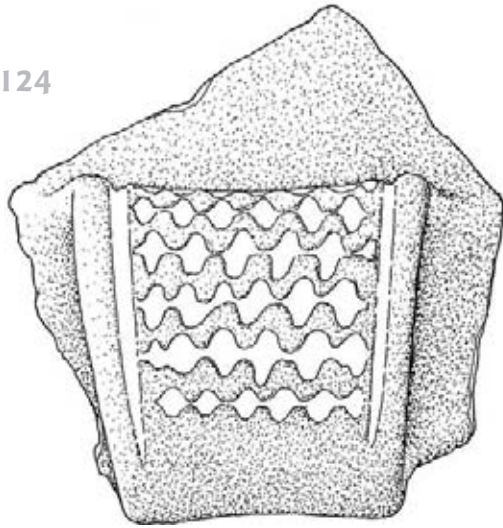

125

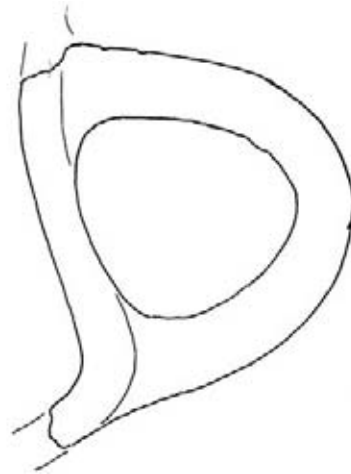
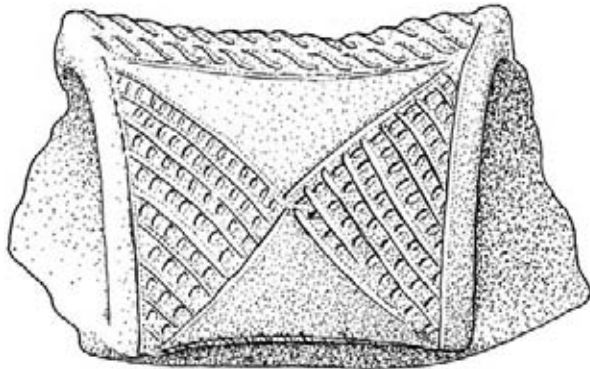

126

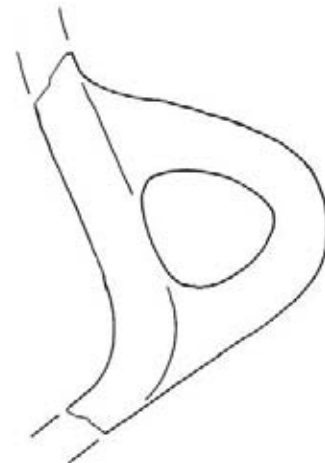
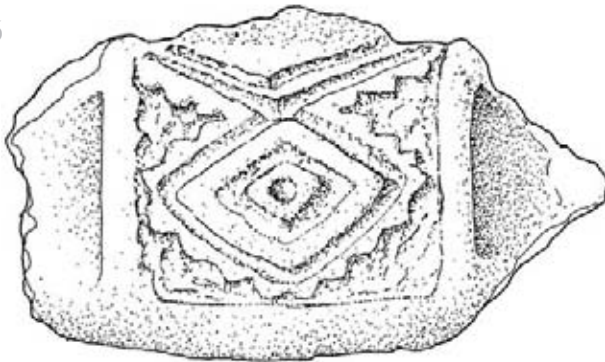

127

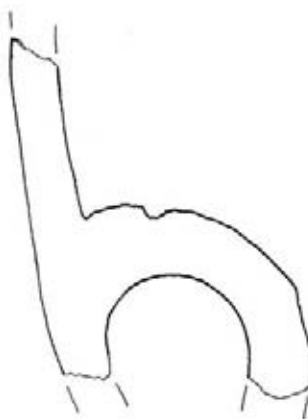
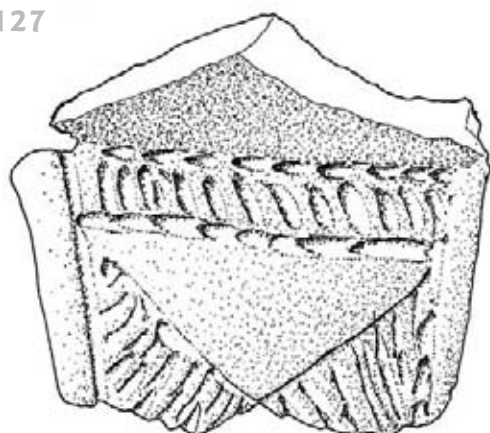

128

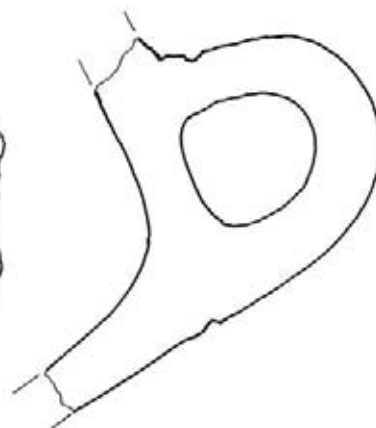
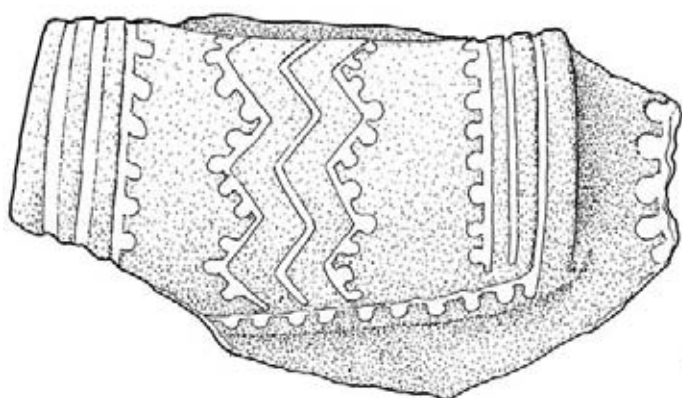

129

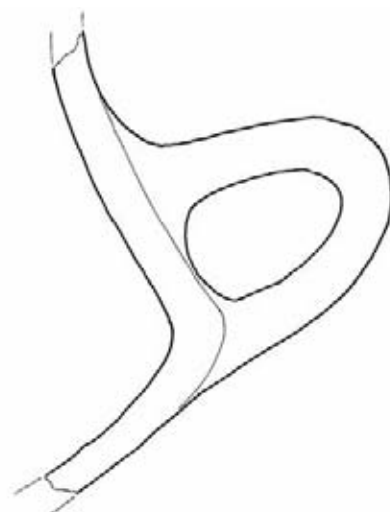
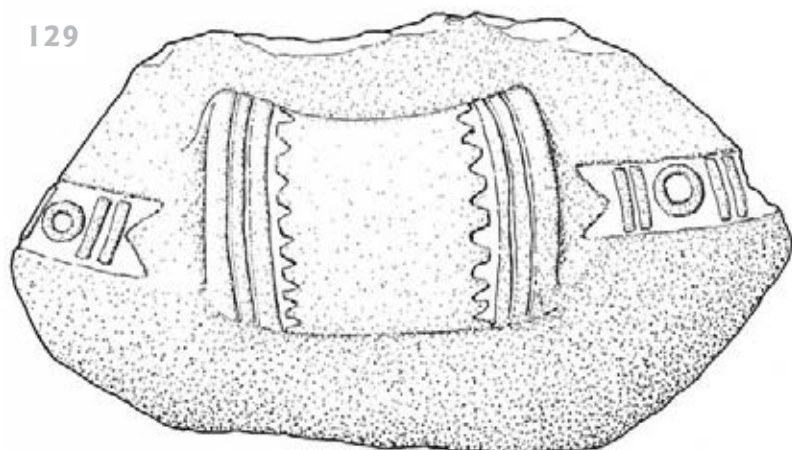

130



Tabla 36

131



132

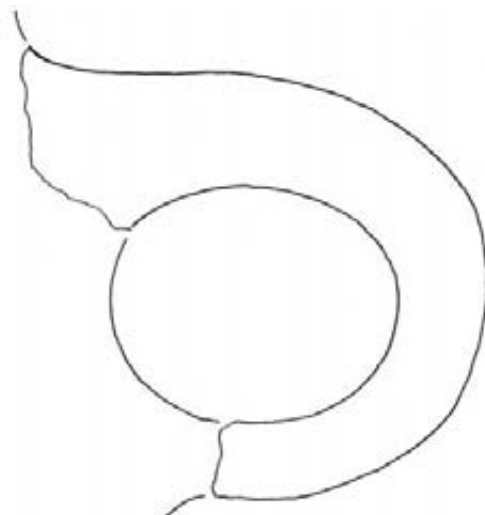
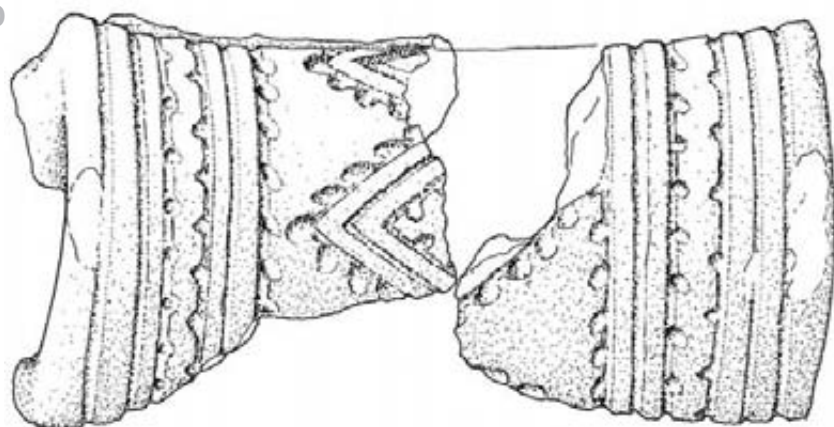
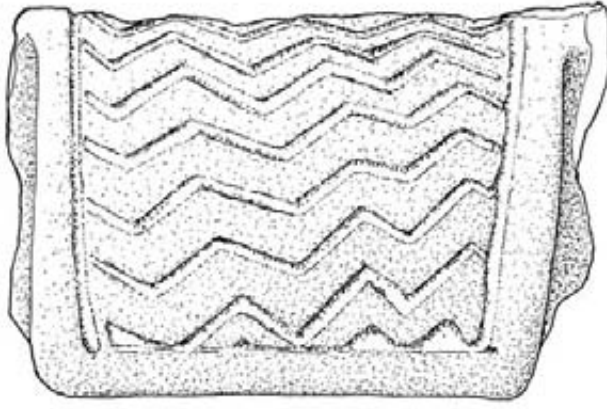
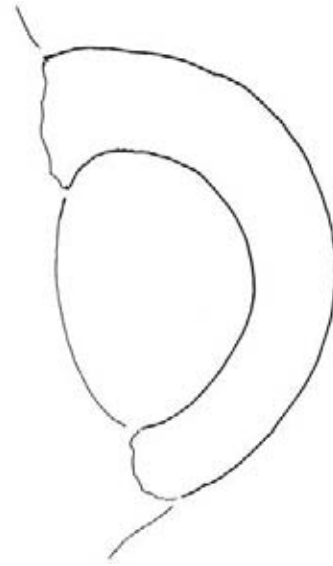
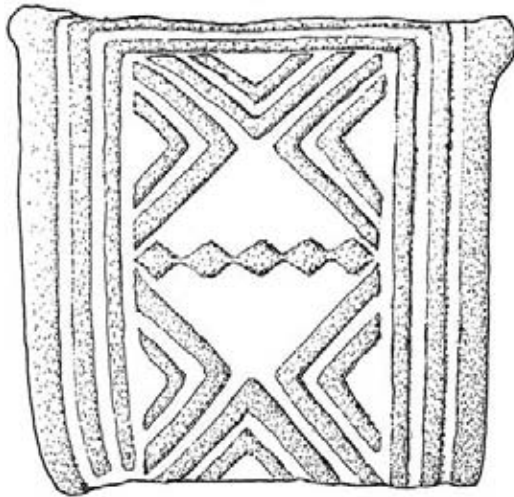

133

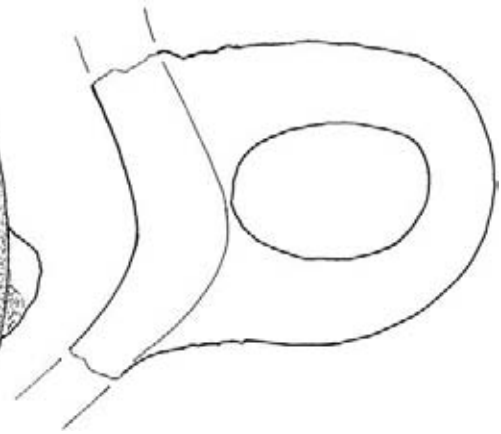
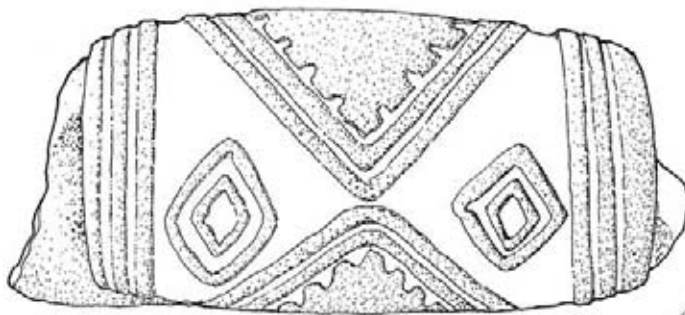

134

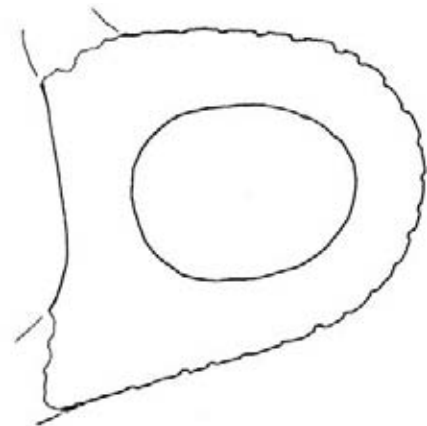
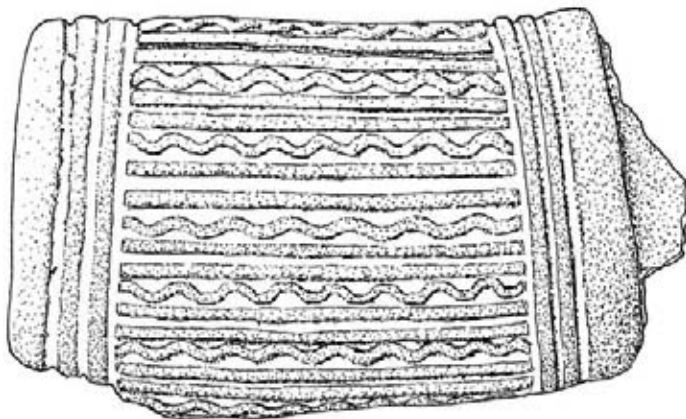

135

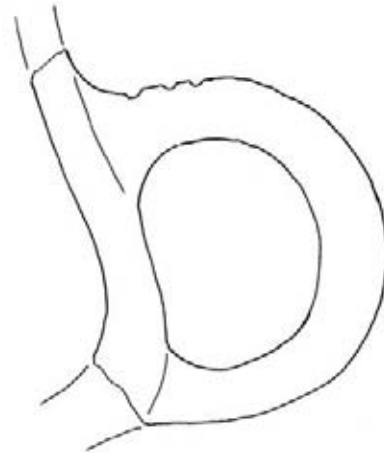
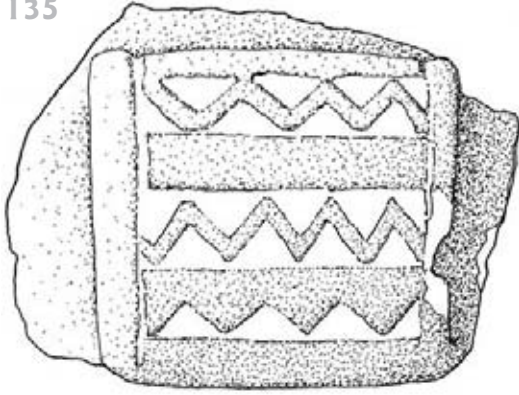

136

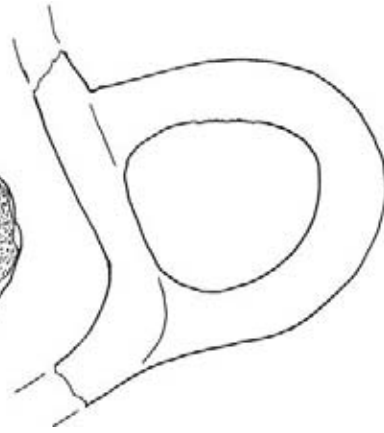
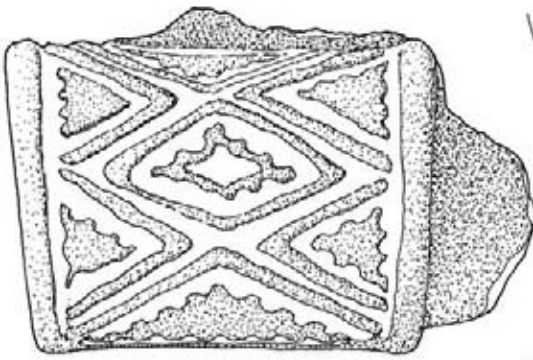

137

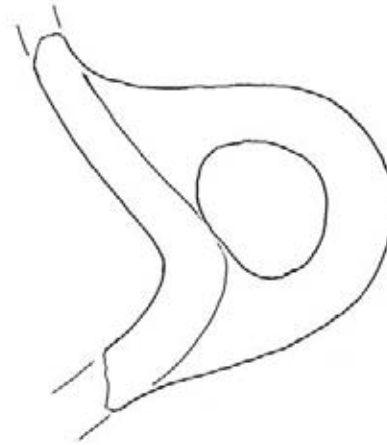
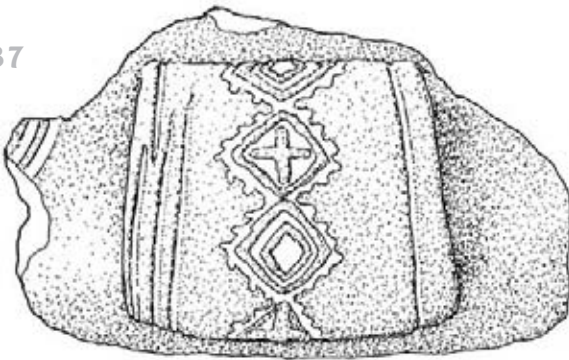

138



Tabla 38

139



140

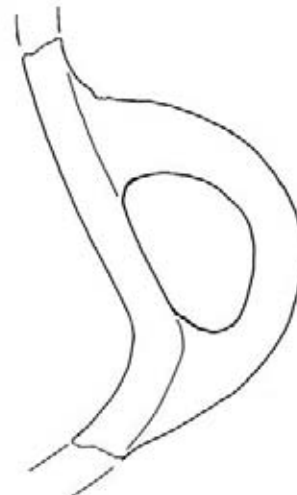
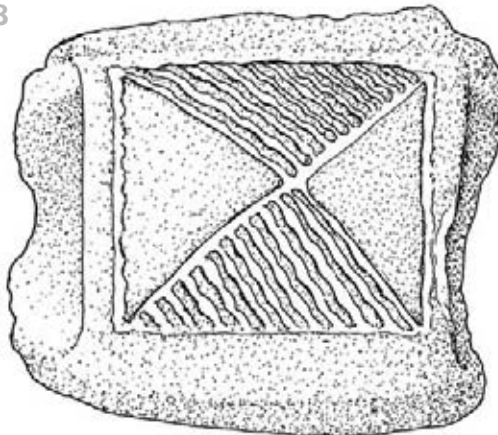
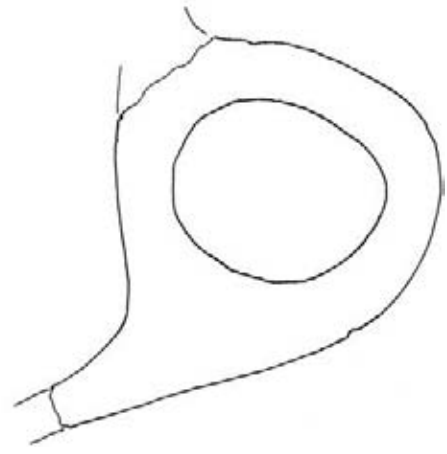
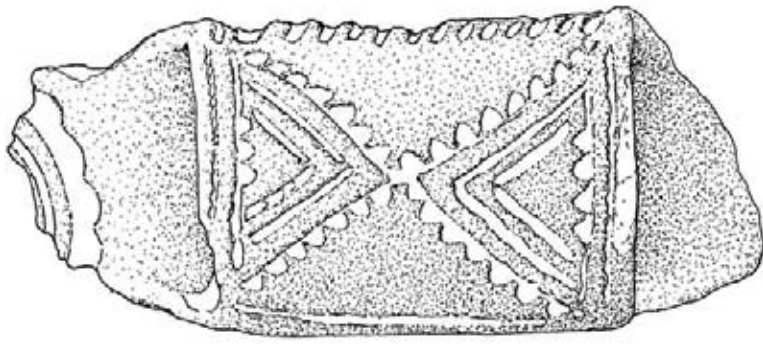
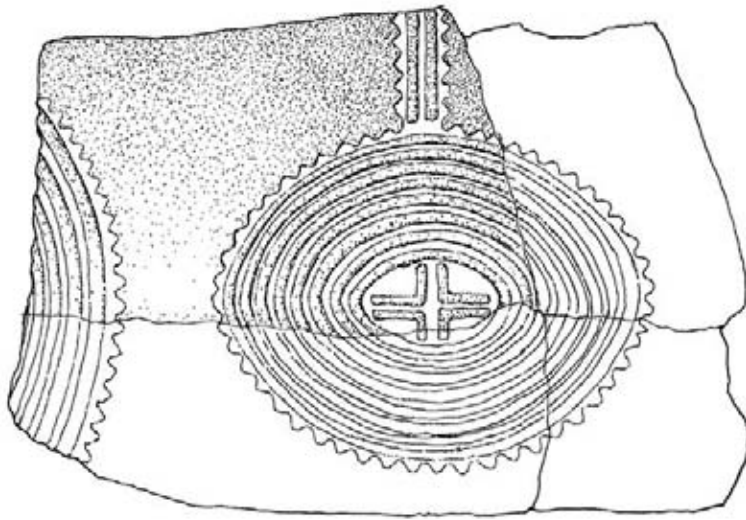

134

141

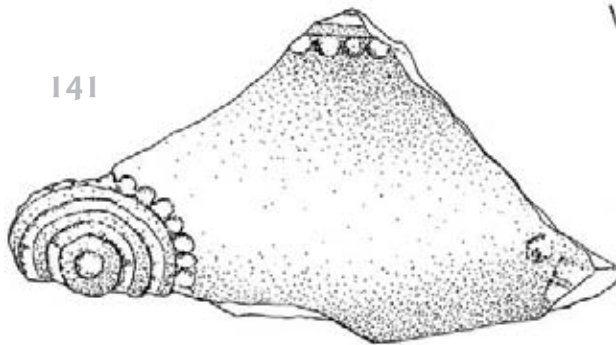

142



Tabla 39

143



144

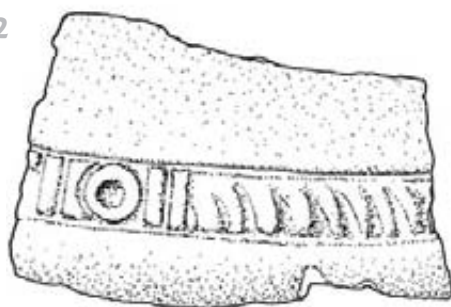
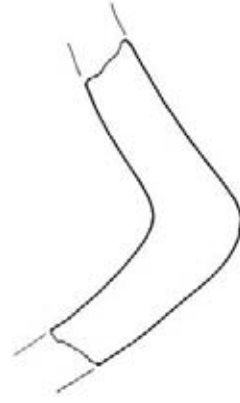
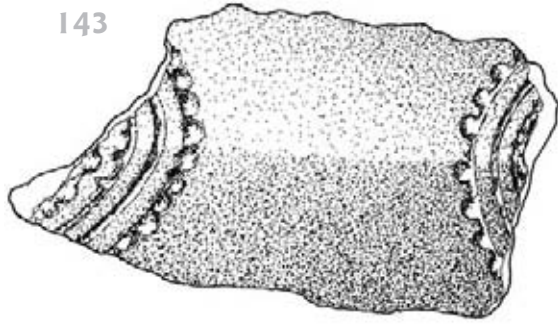
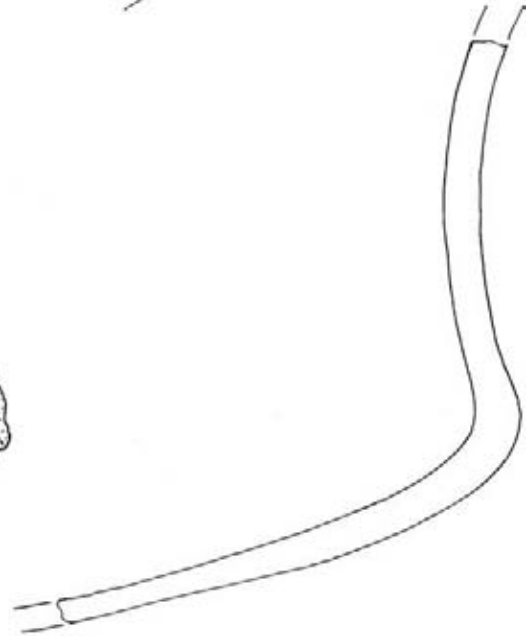
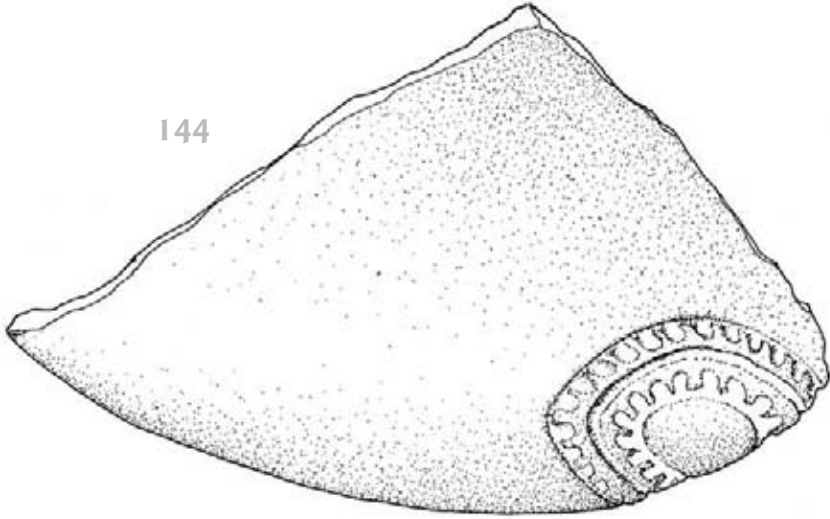

145

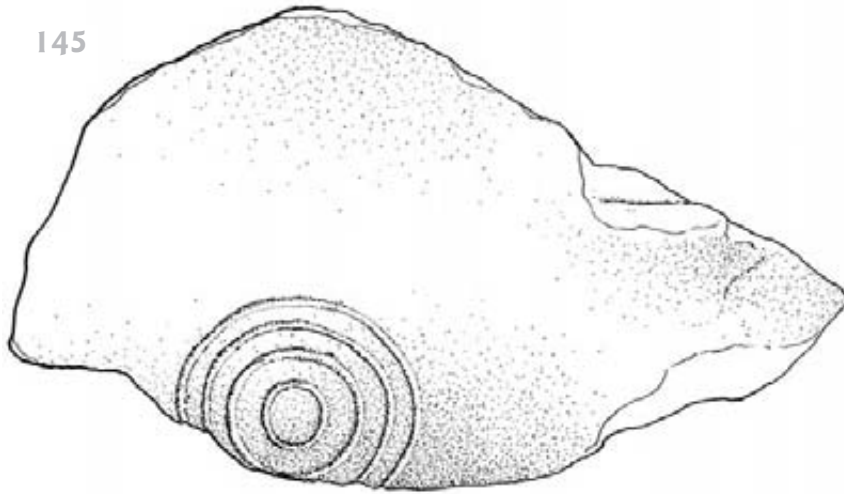

146



Tabla 40



147

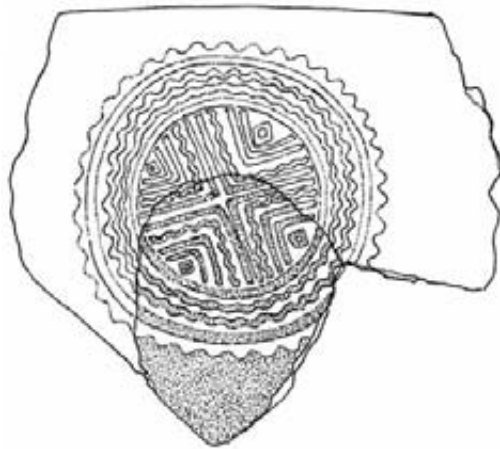
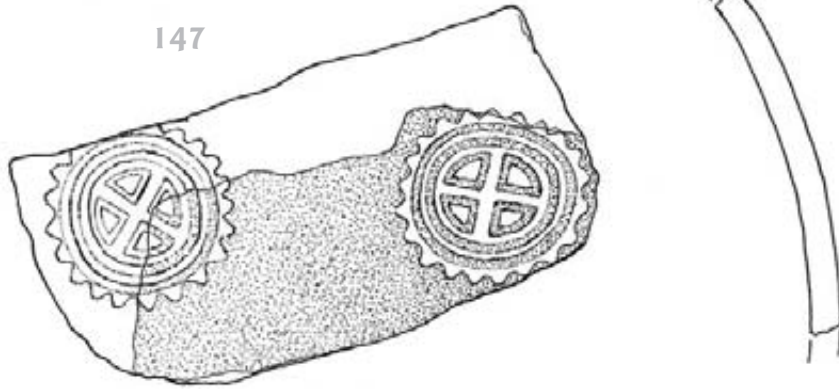

148

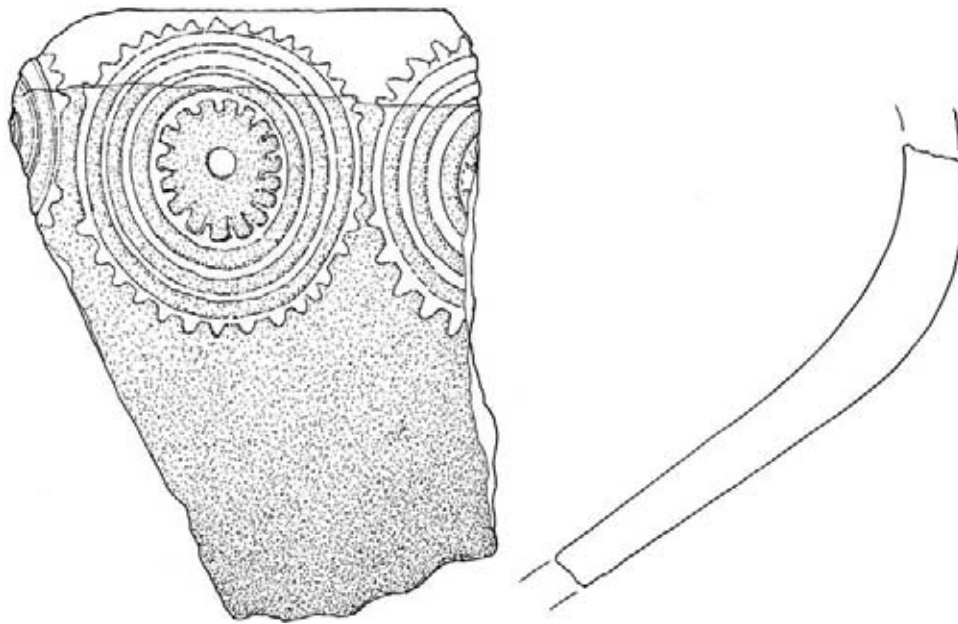

149

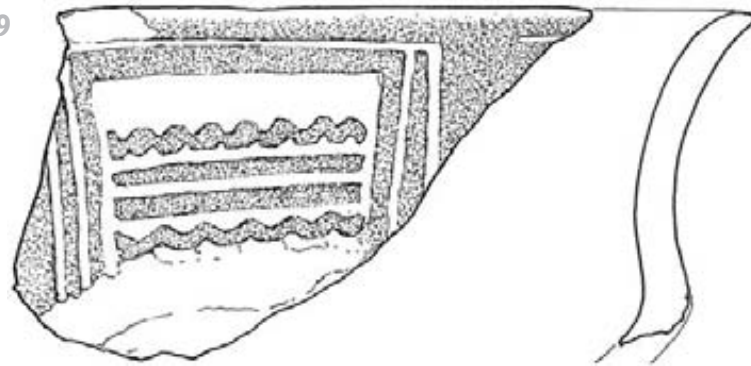

150



Tabla 41



Tabla 42

154

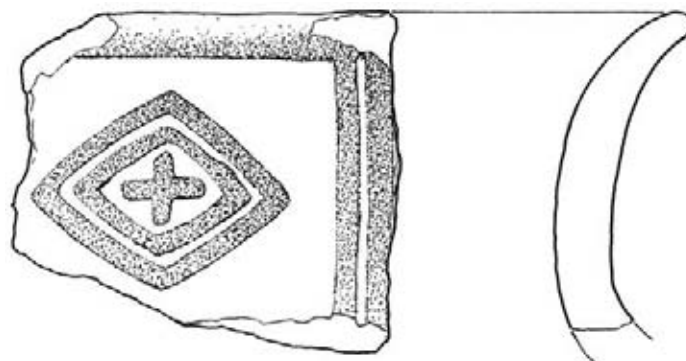

155

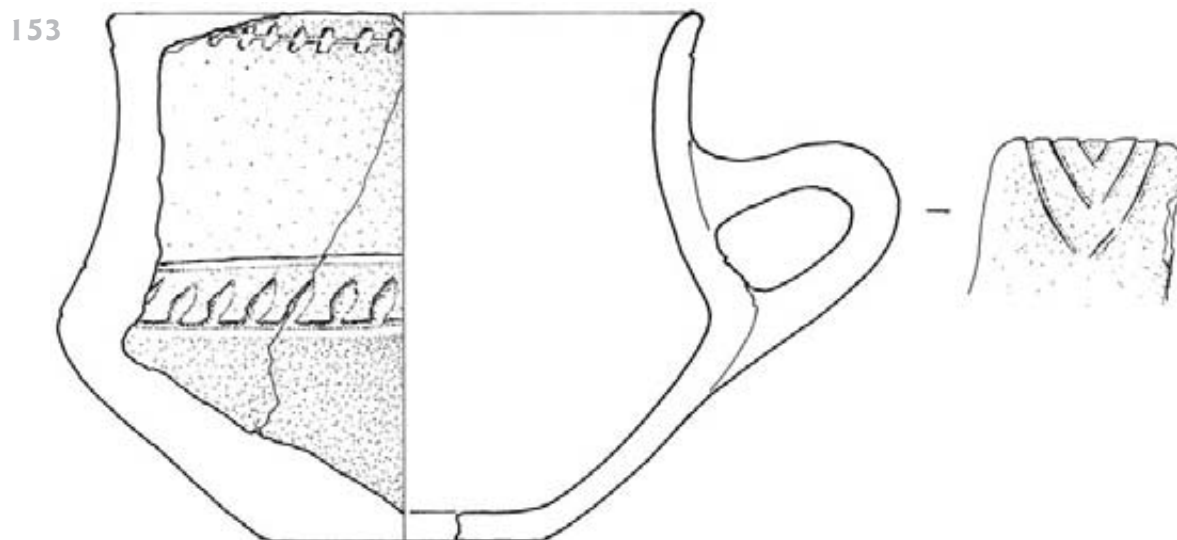
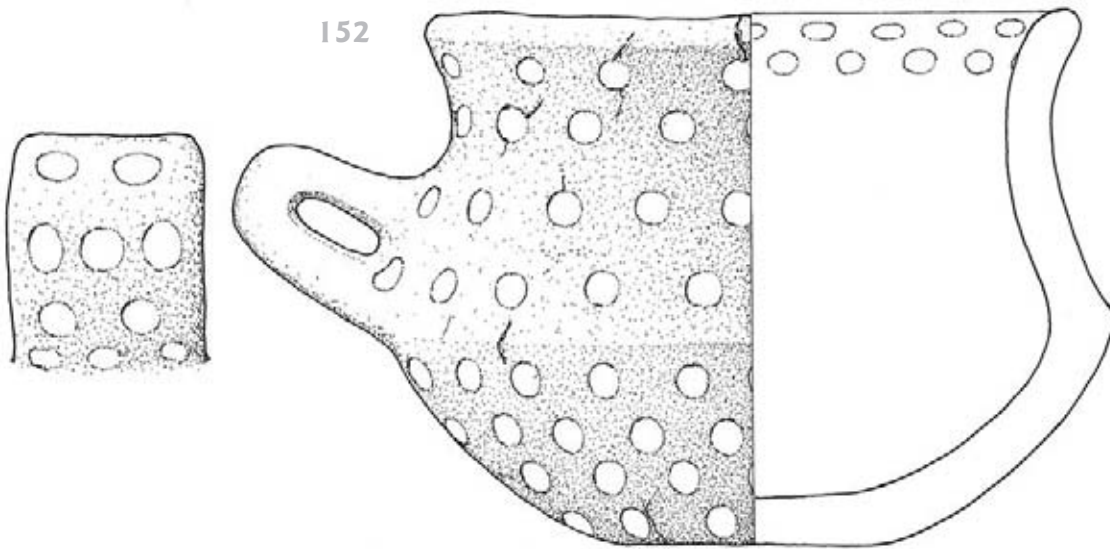
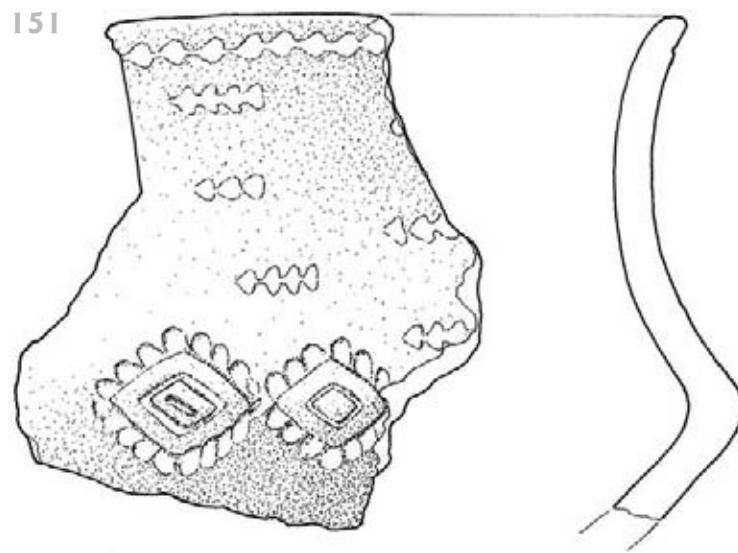
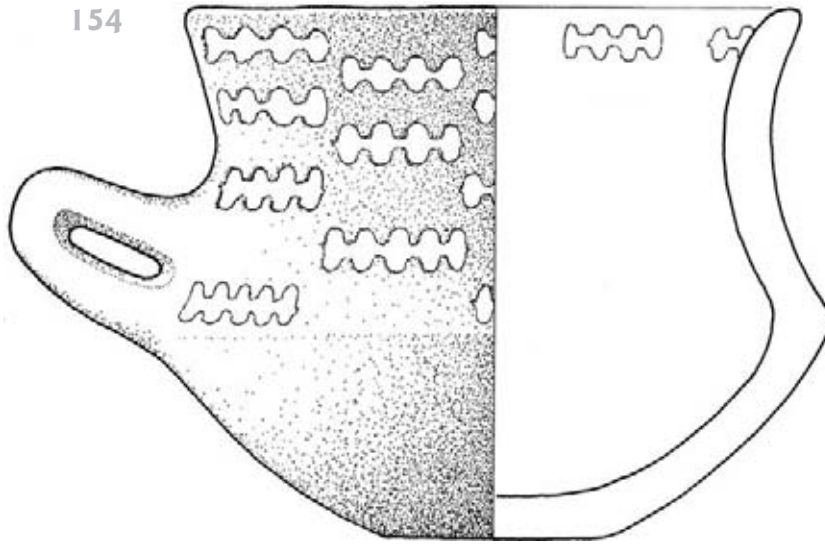
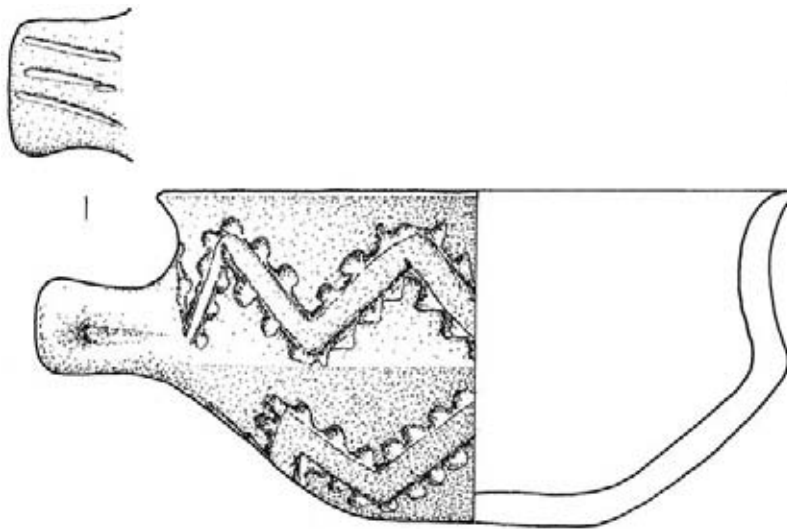

156

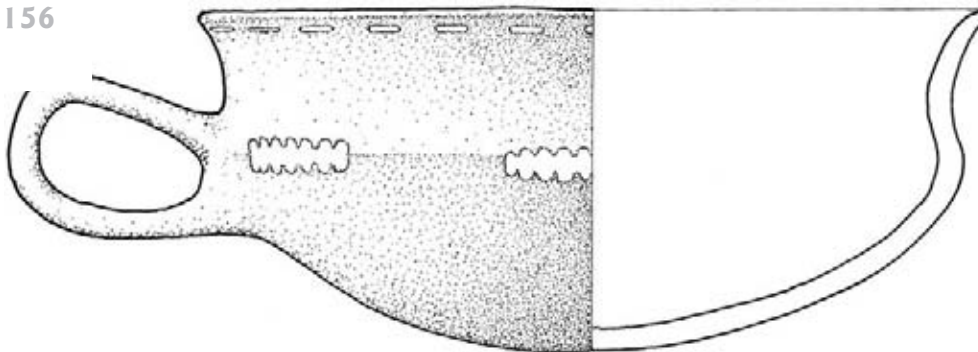

157

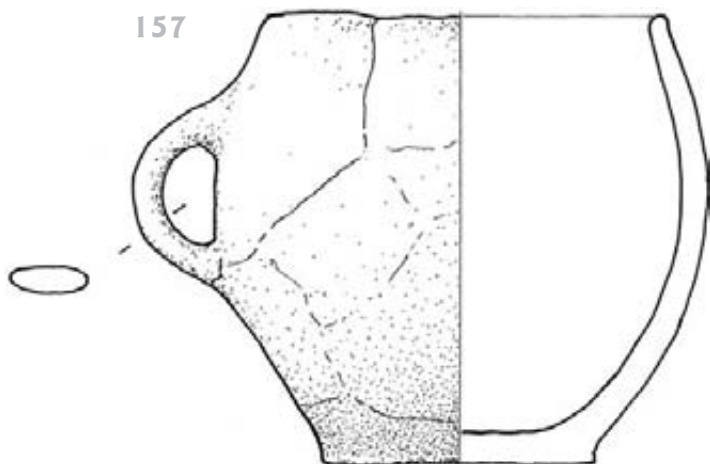

158



Tabla 43

159



161

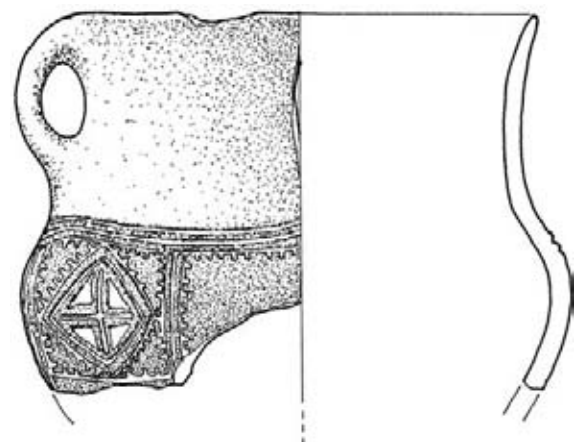
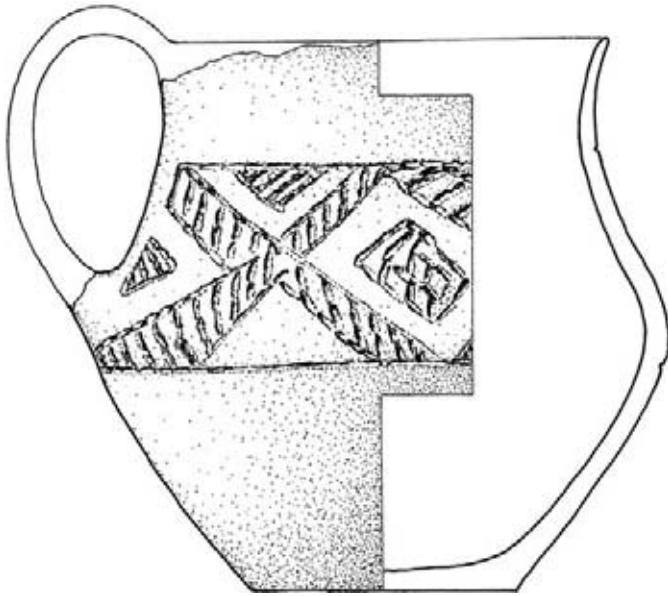
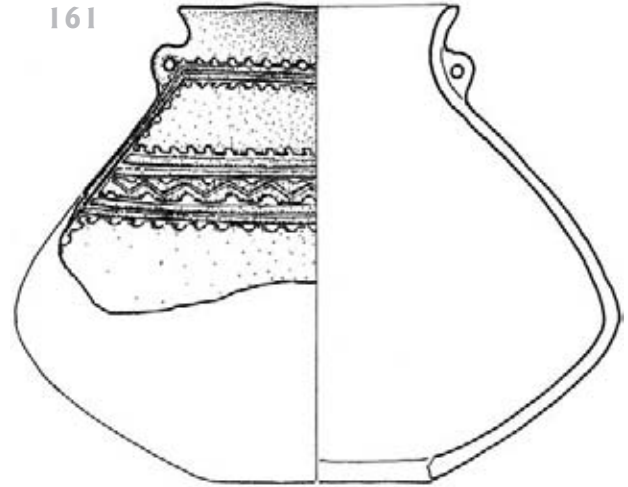

160

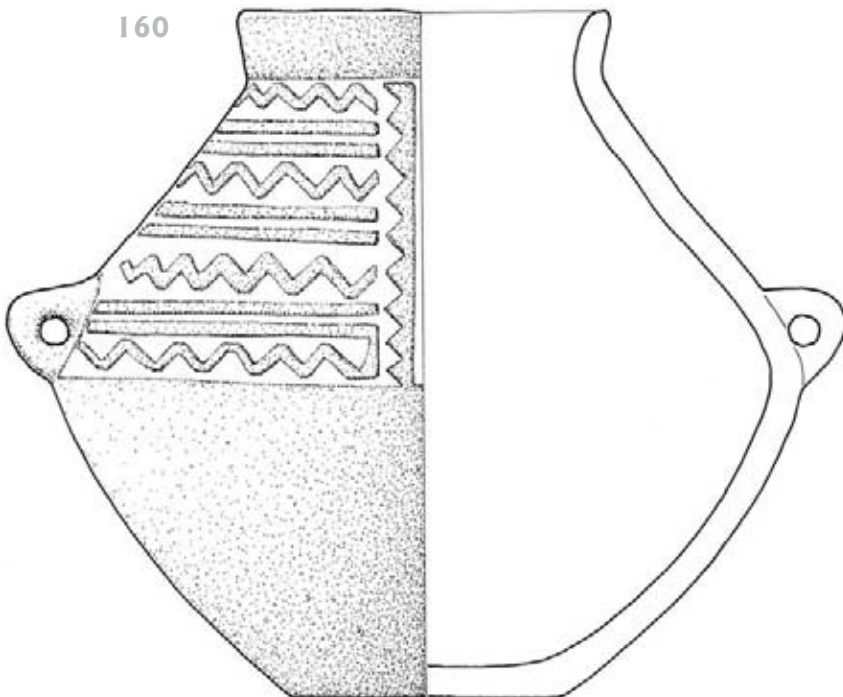

162

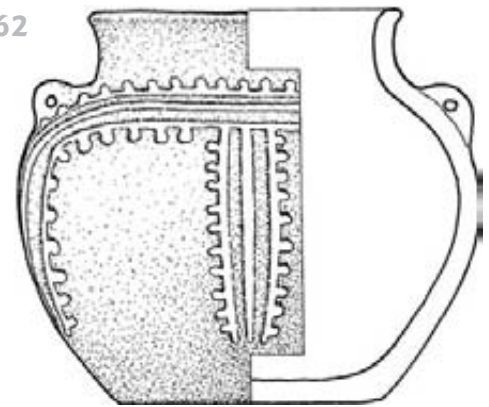

163

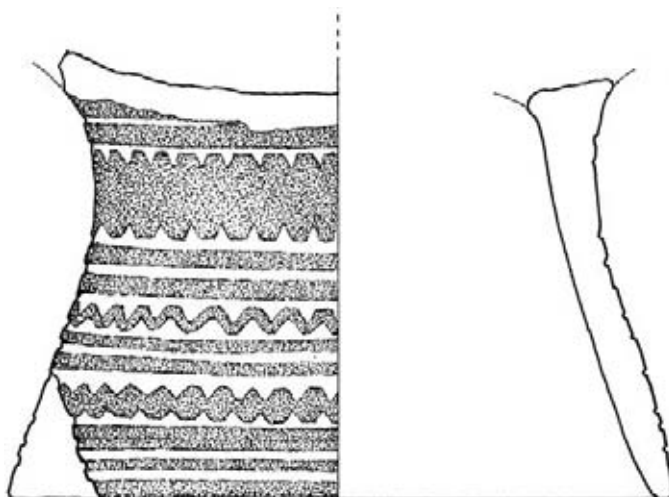

164



Tabla 44

165



166

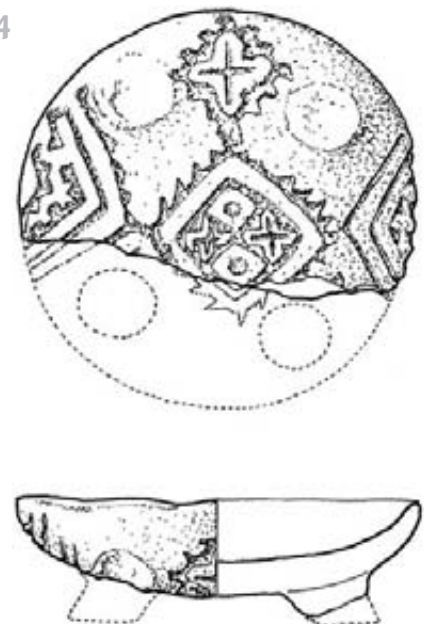
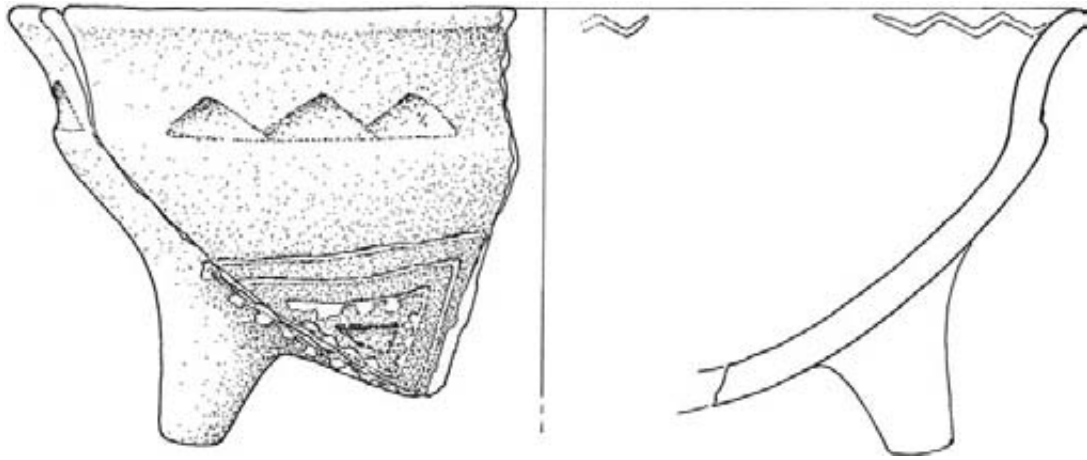
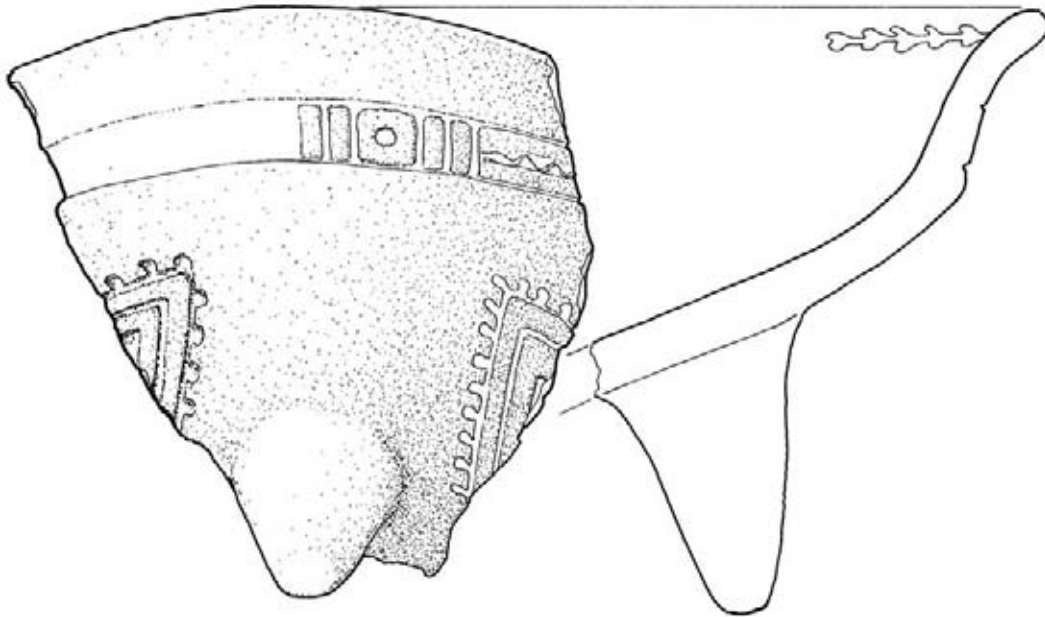

167

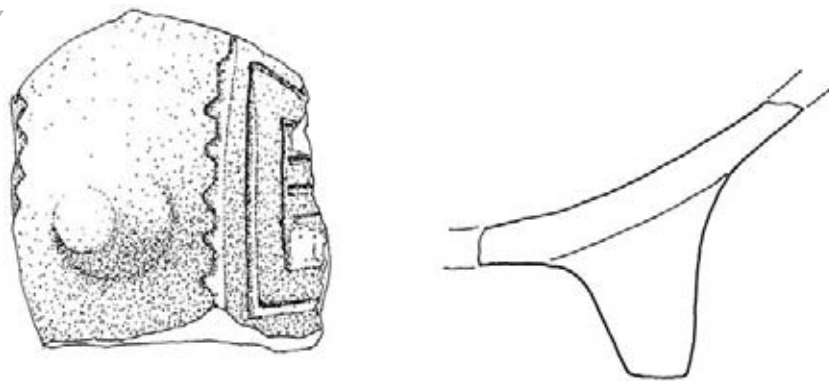

168

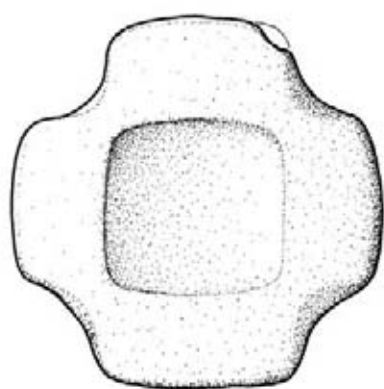
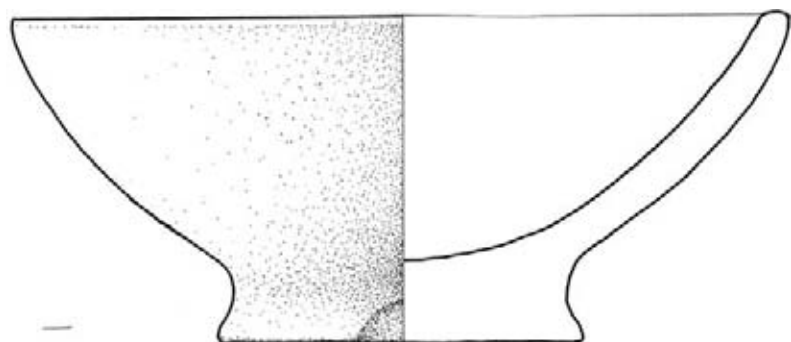

169

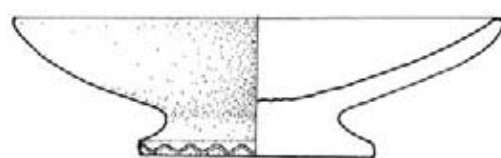
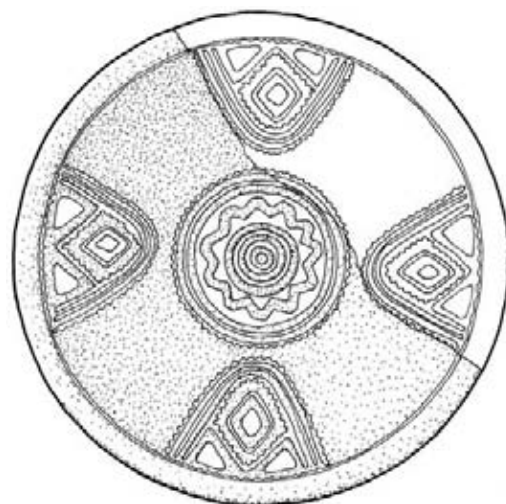

170

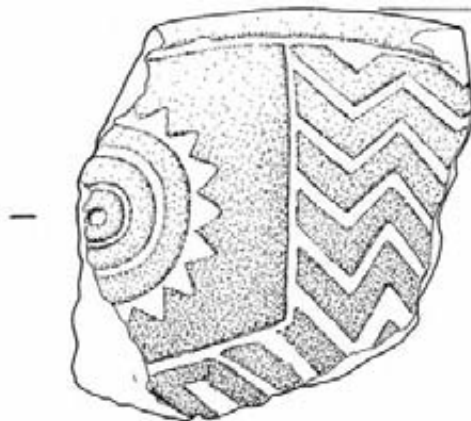
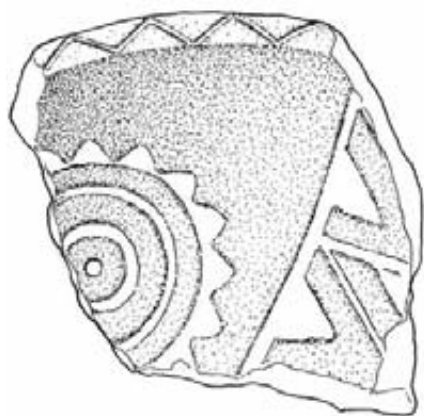

171

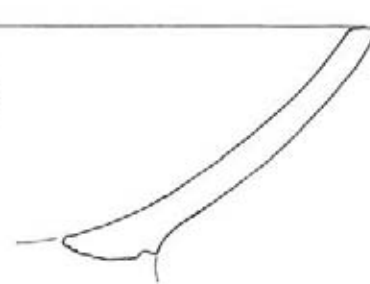
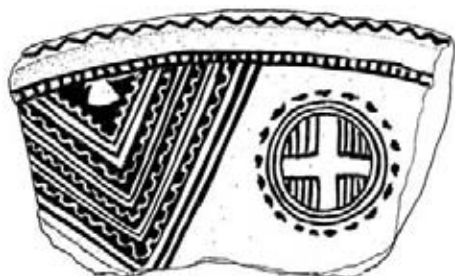

172



Tabla 46

173



174

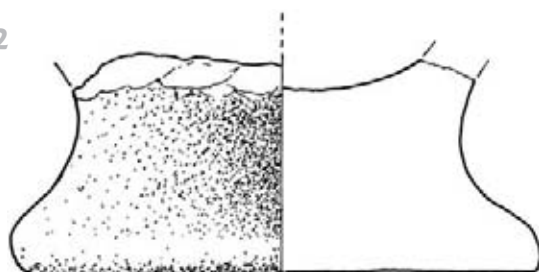
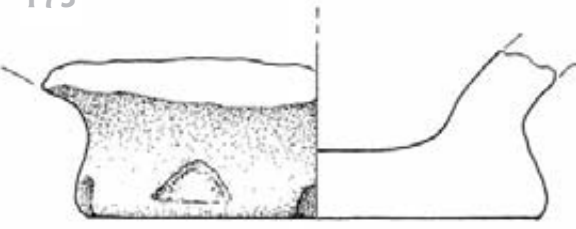
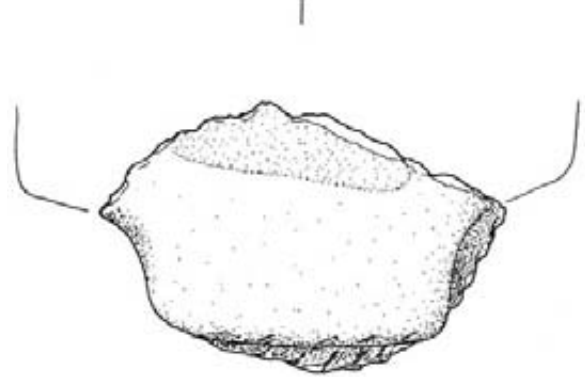
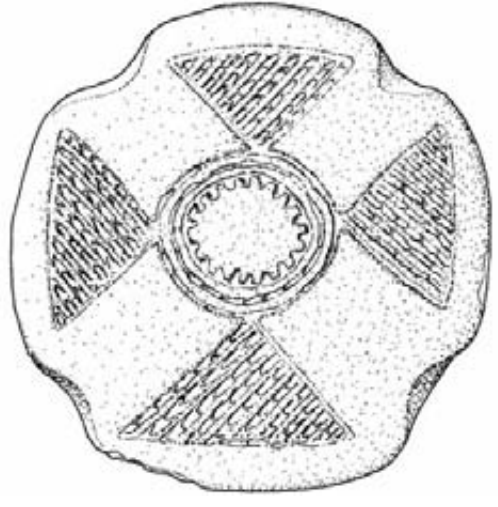
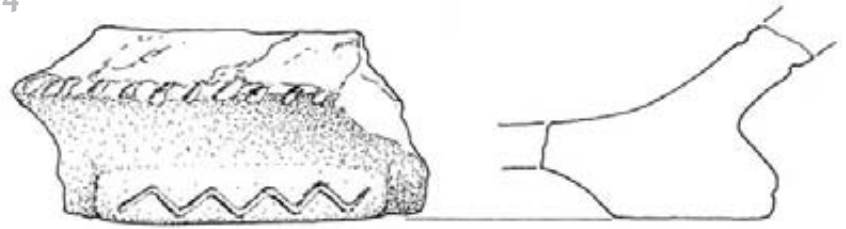

175

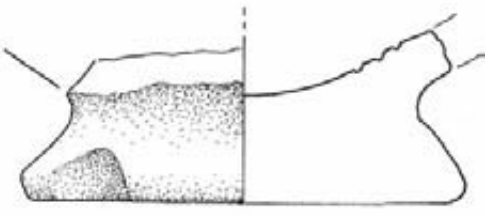

176

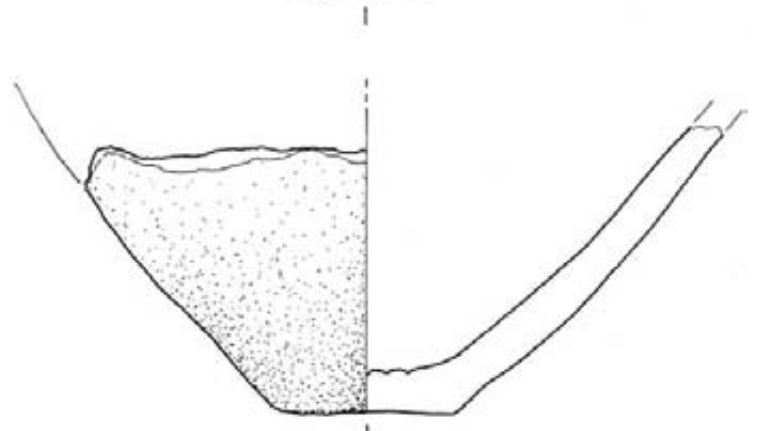
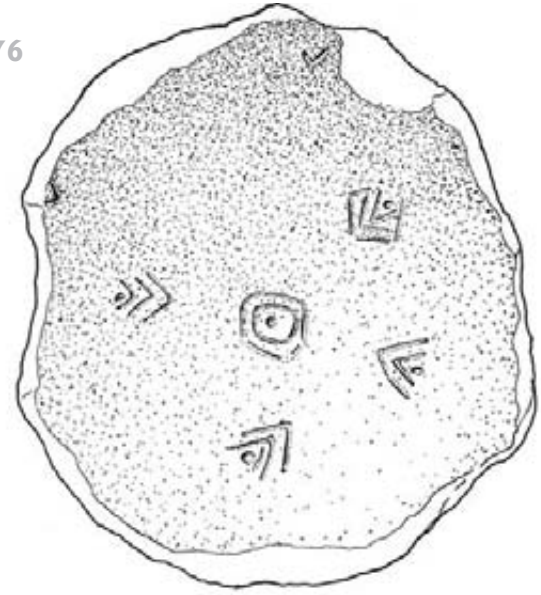

142

Tabla 47

177

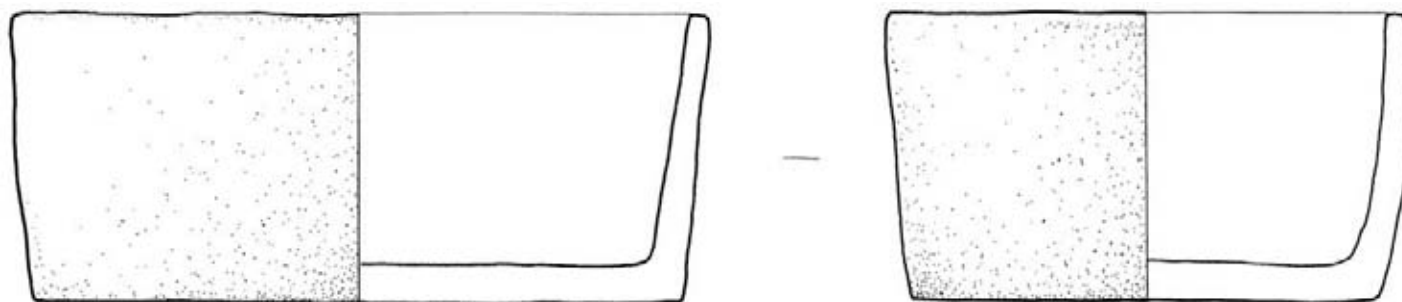

178

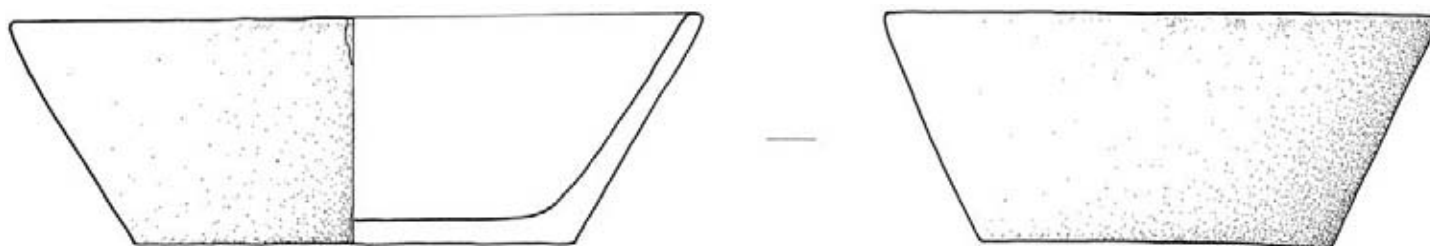

179

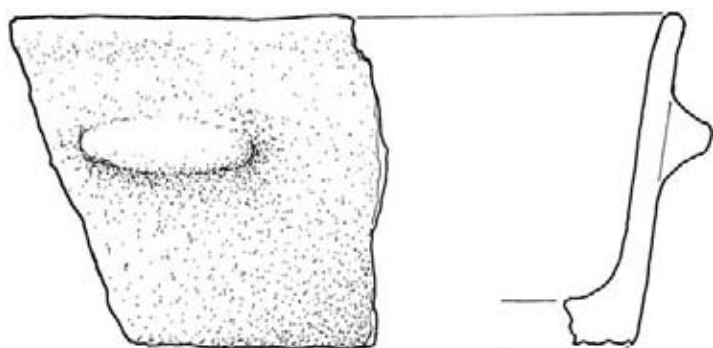

180

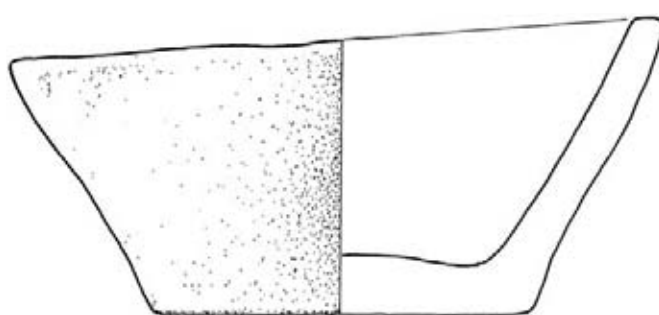

181

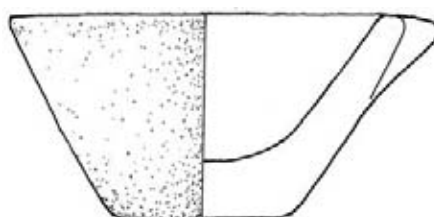

182

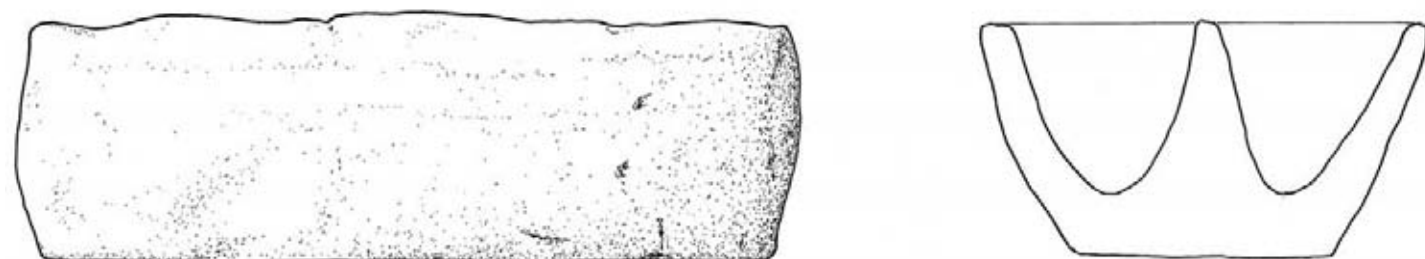



183

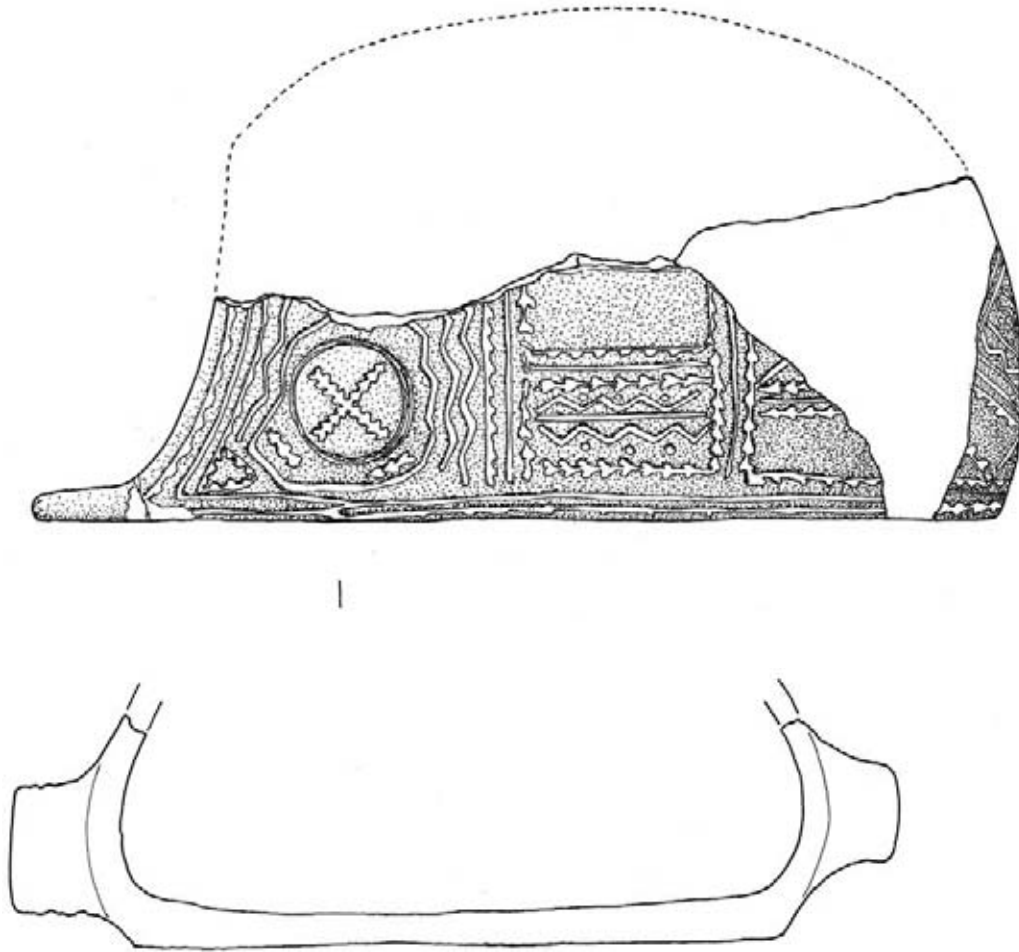

184

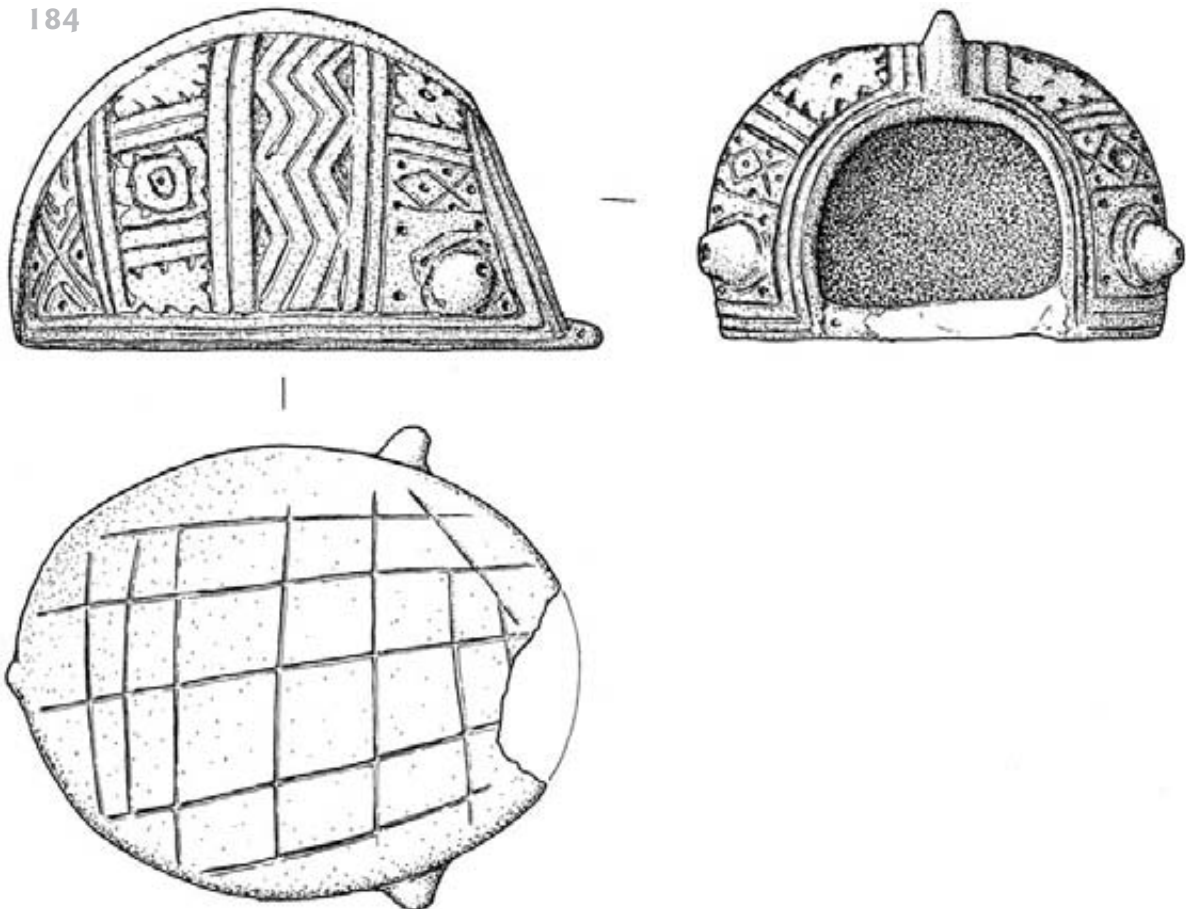

144

Tabla 49

185

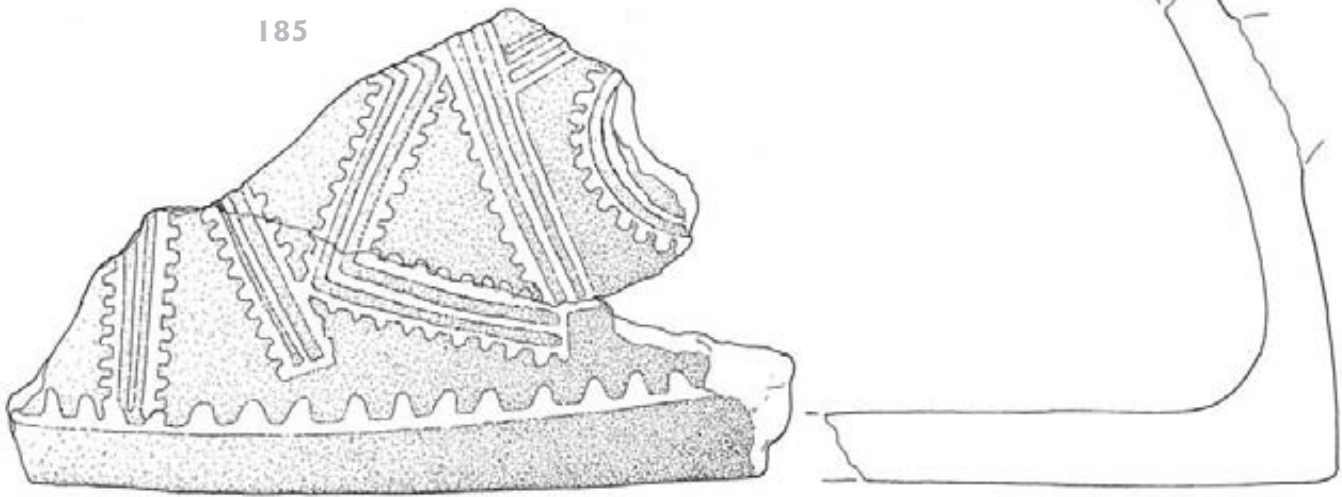

186

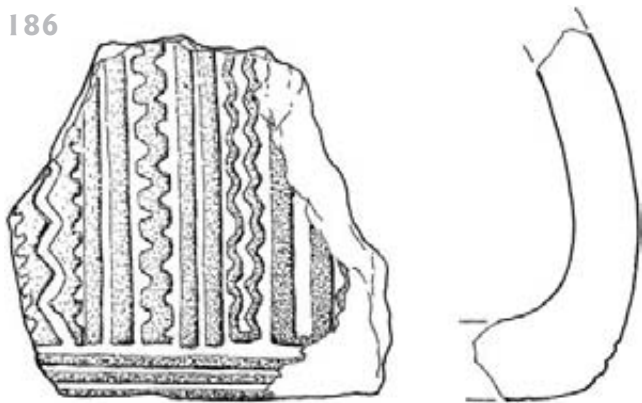

187

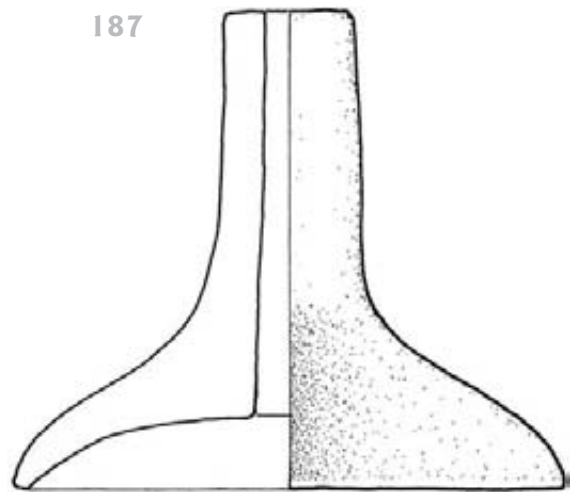

188

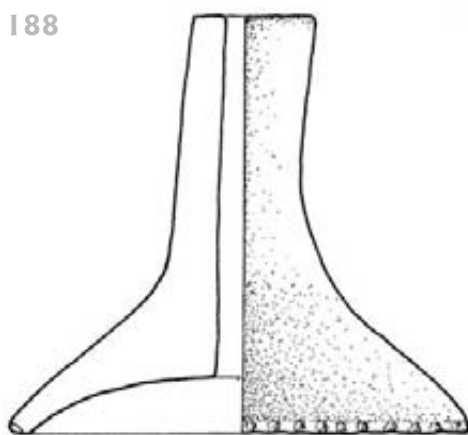

189

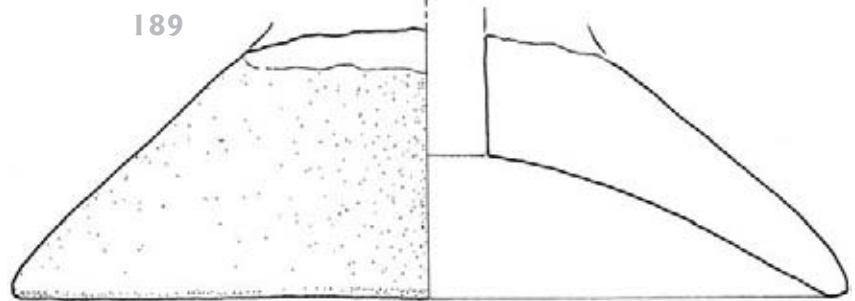

190



Tabla 50

191



194

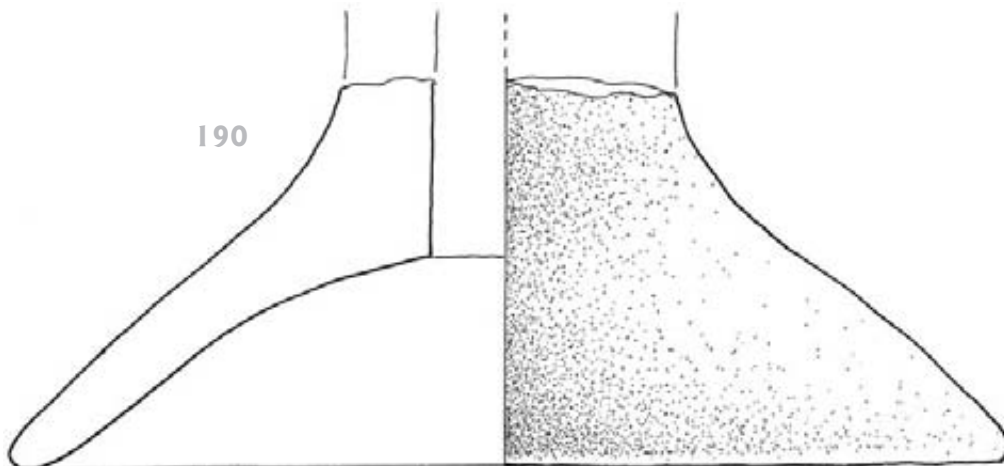
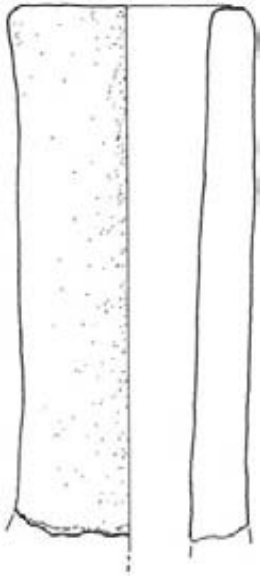
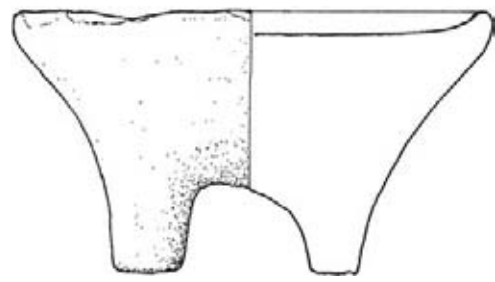

192

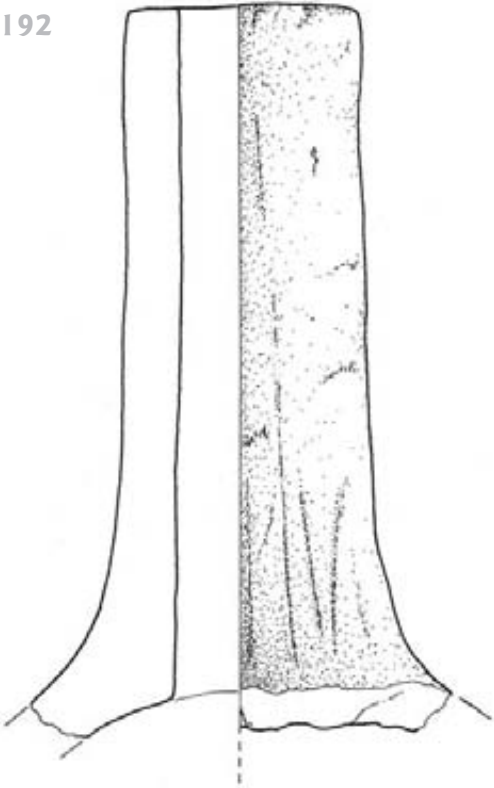

195

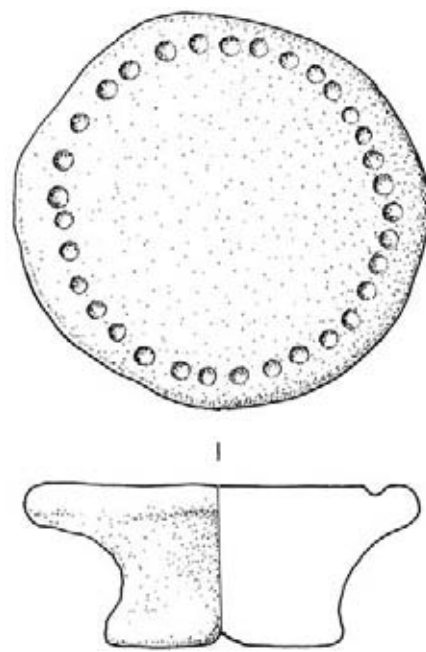

146

193

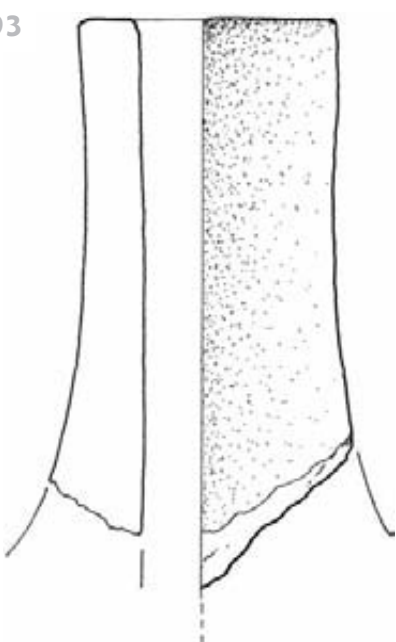

196



Tabla 51

197



Tabla 52

198



199

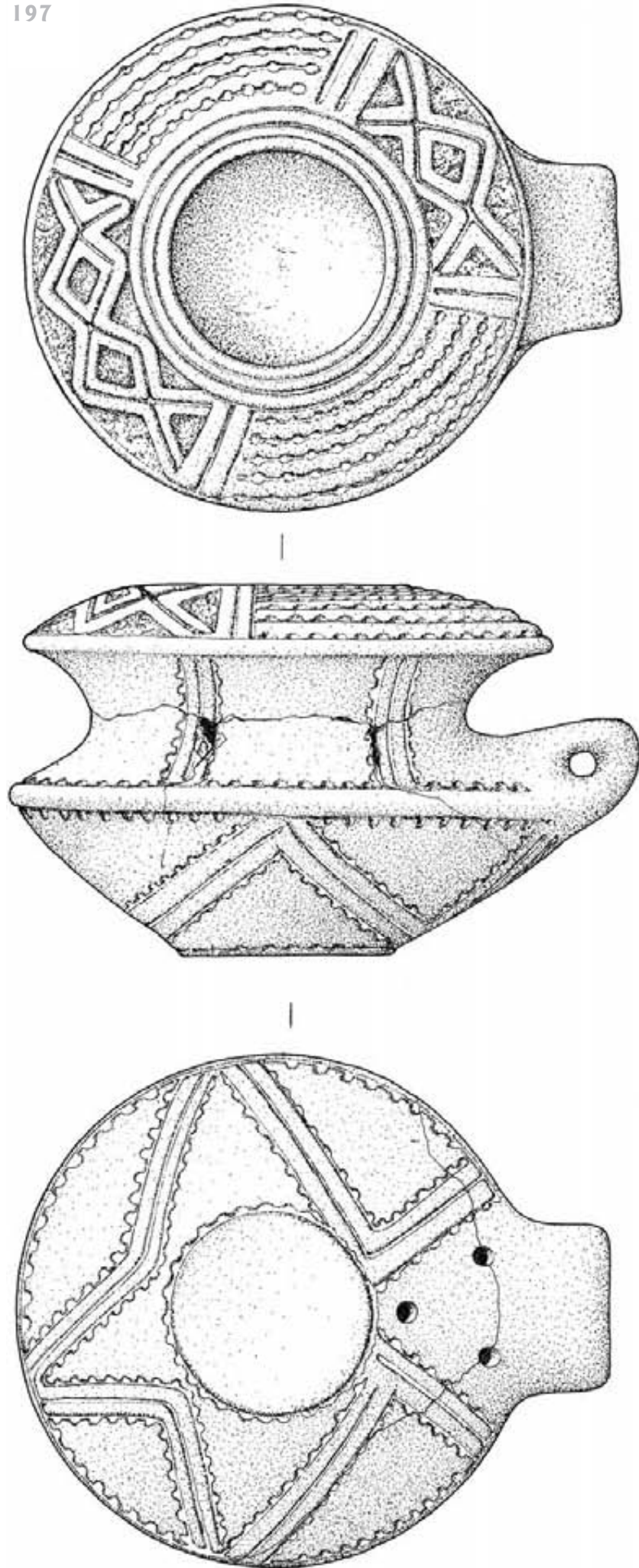
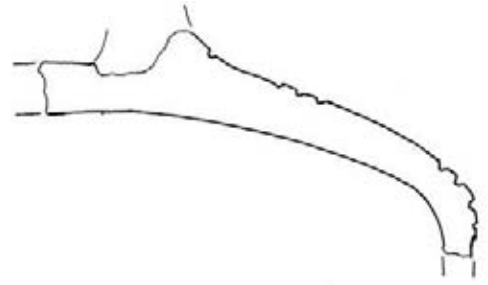
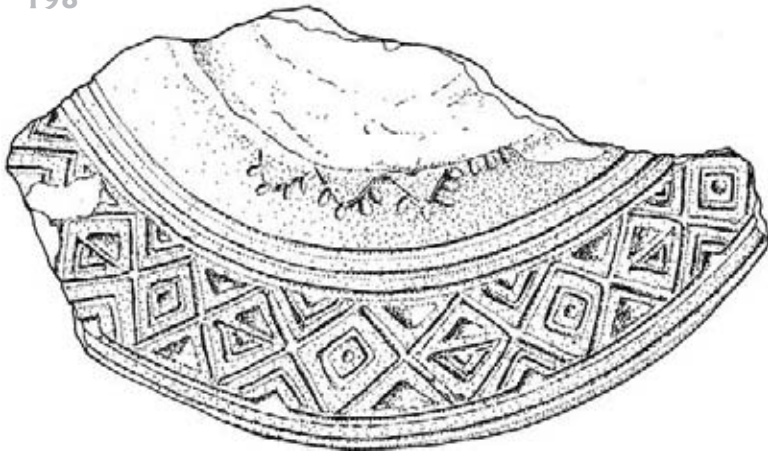
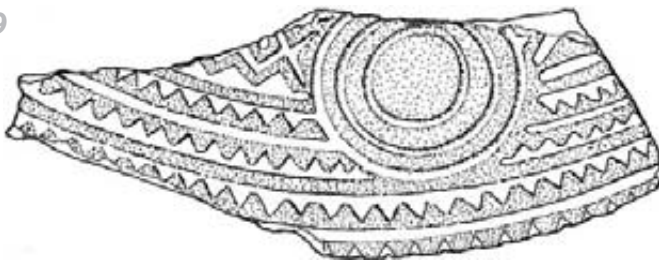

148

200

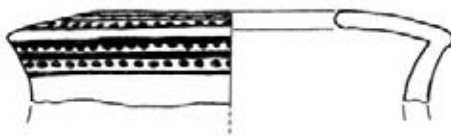

201



Tabla 53

202



203

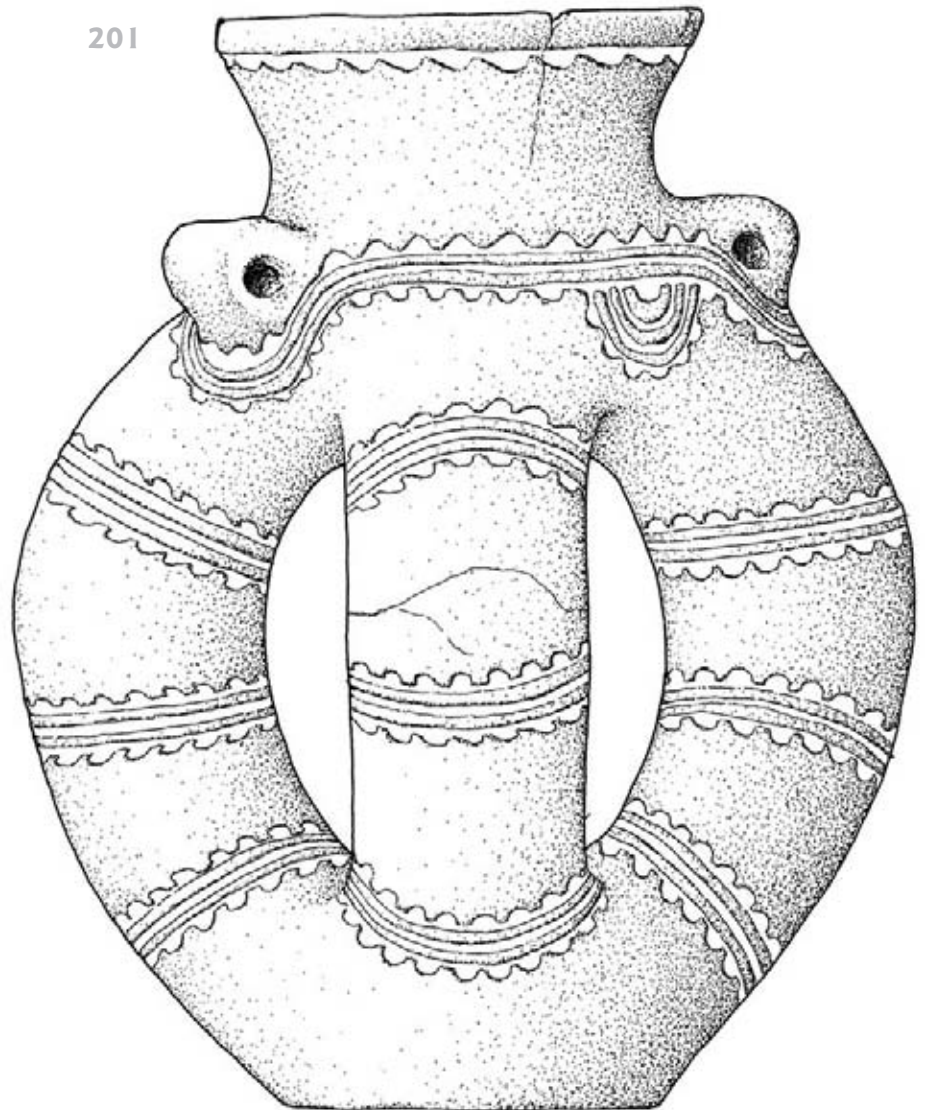
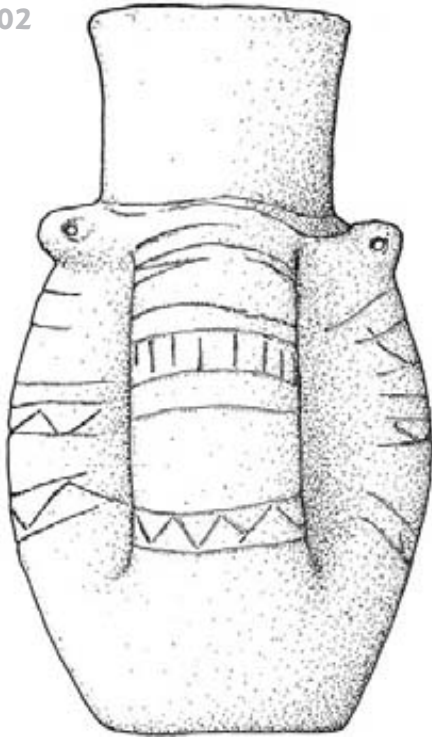
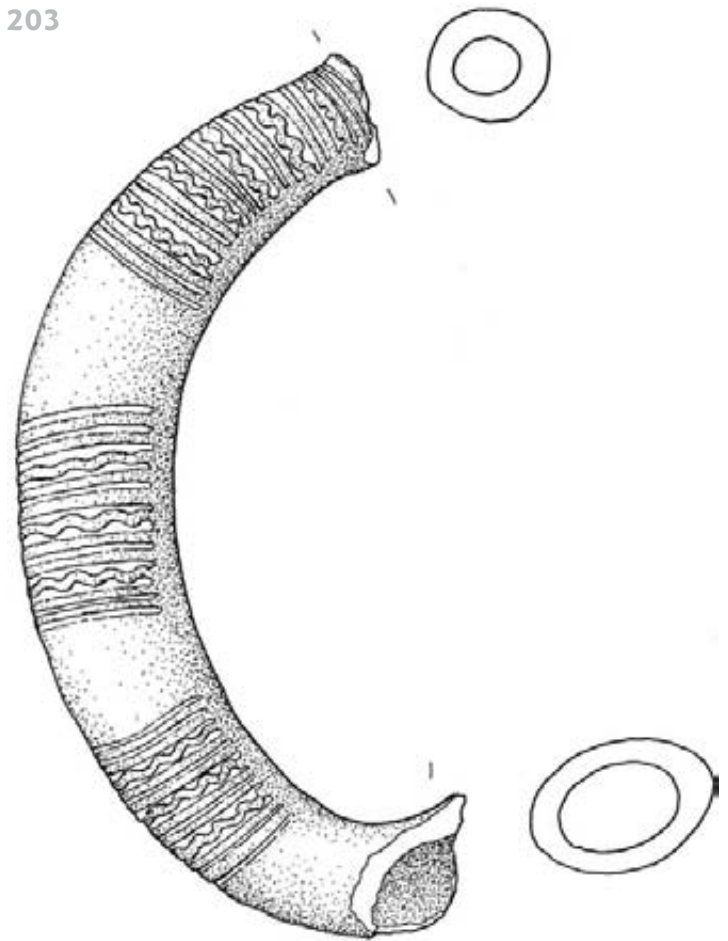

204



205

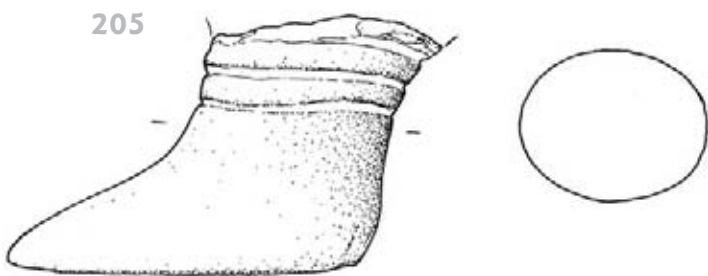

206



Tabla 54

207

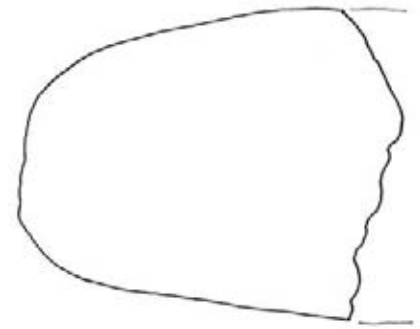
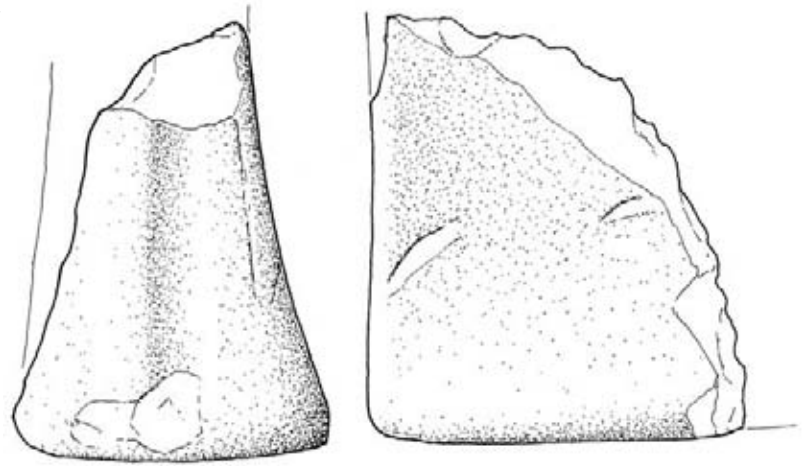

208

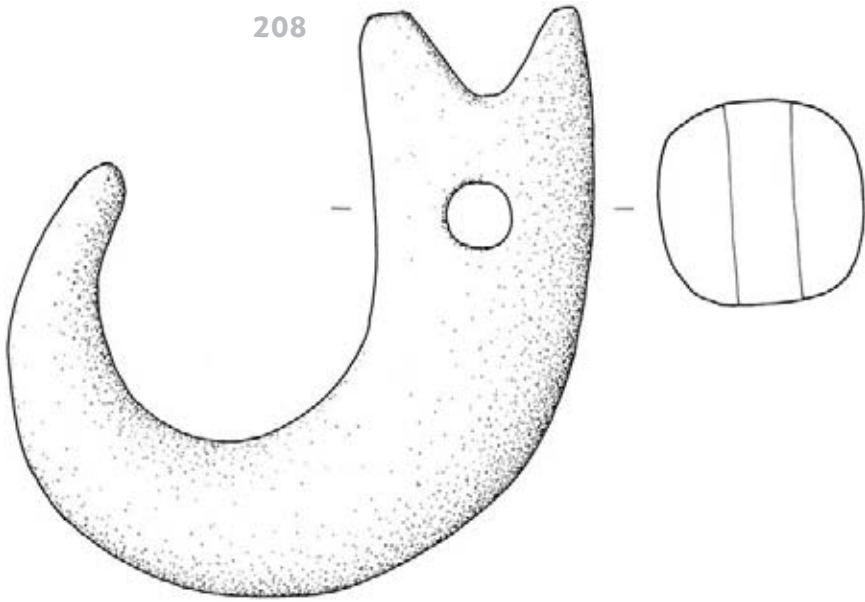

209



Tabla 55



Tabla 56



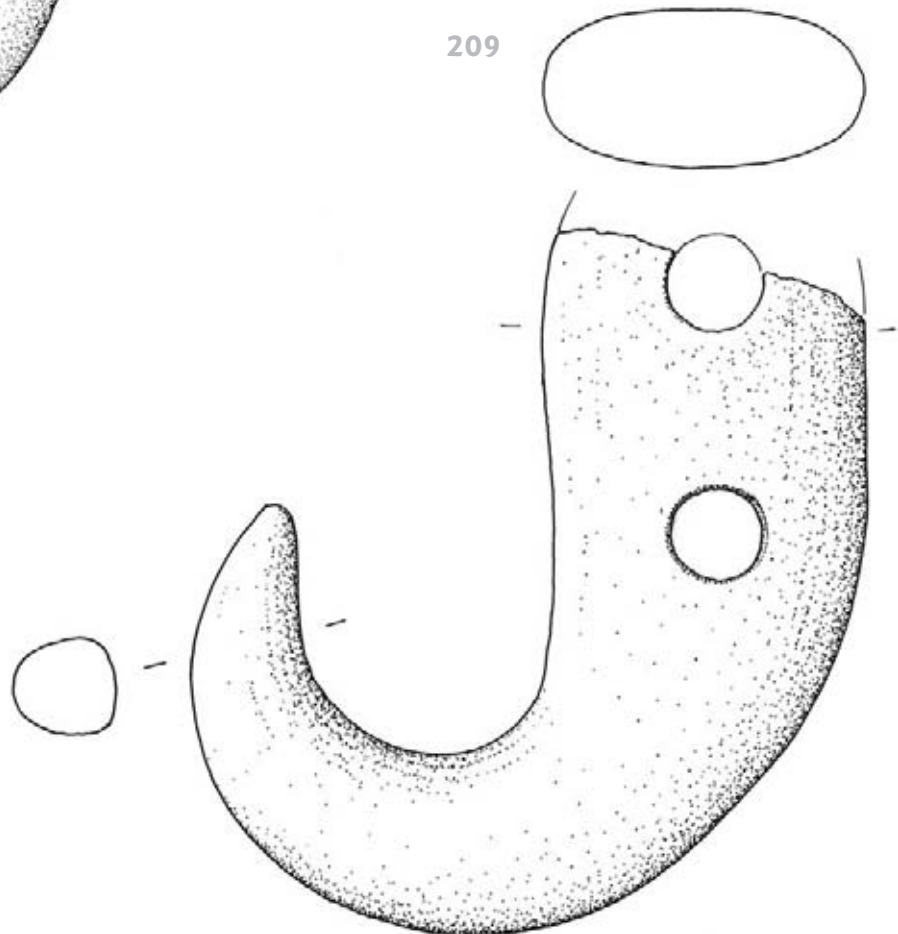

217

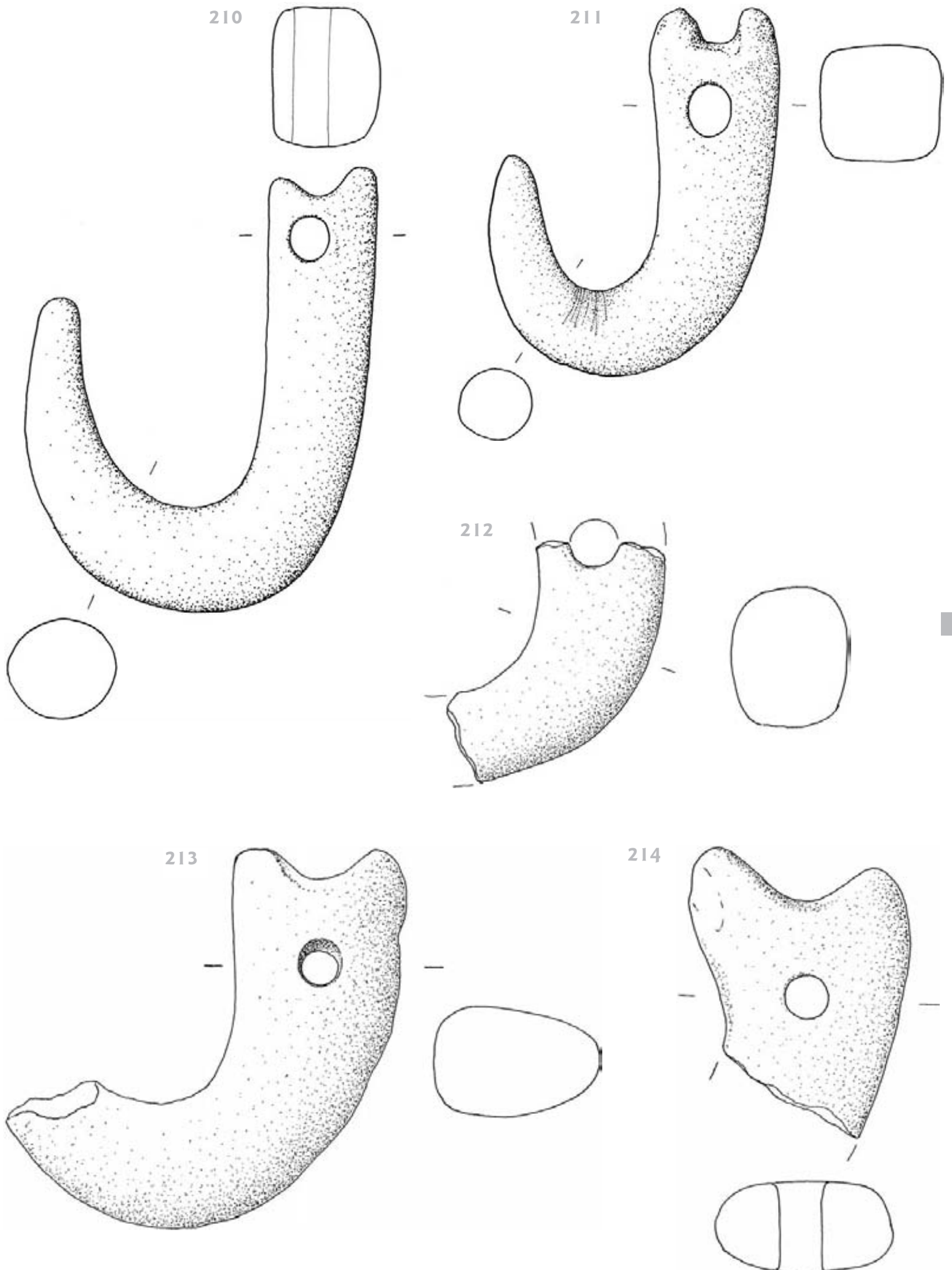
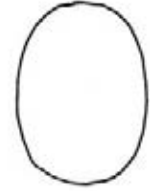
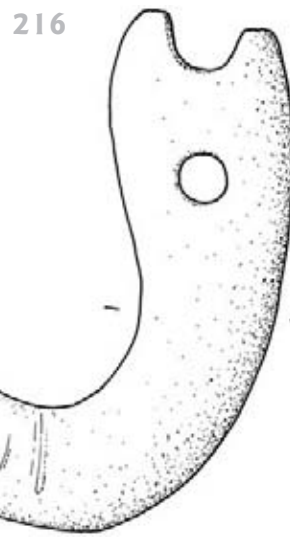
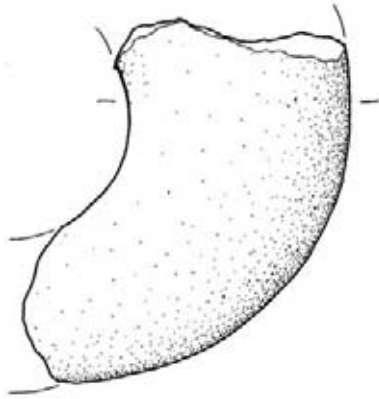
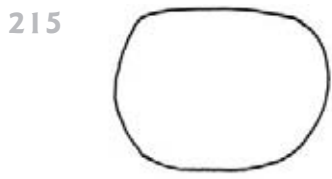
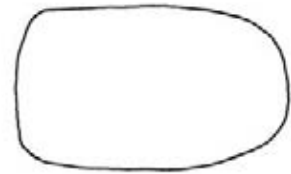
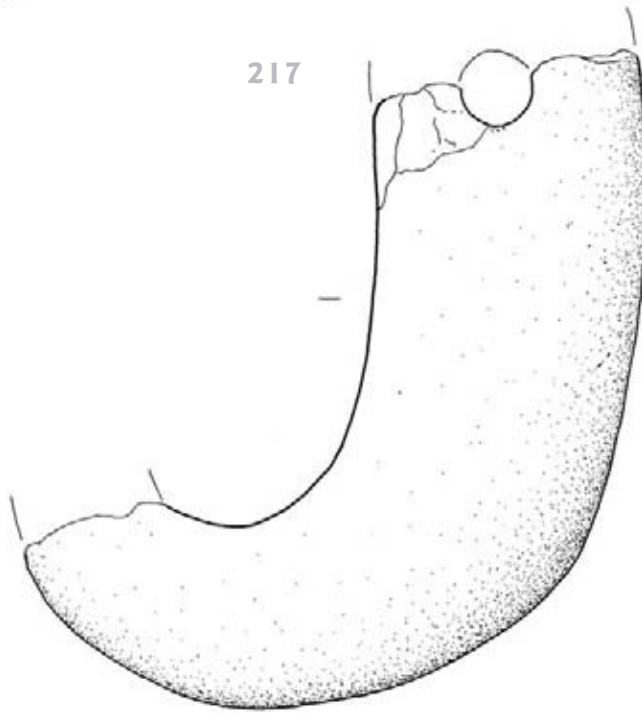

218

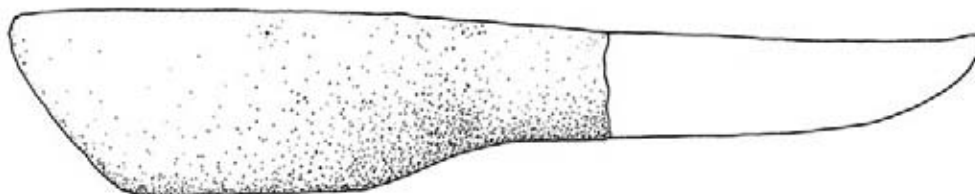
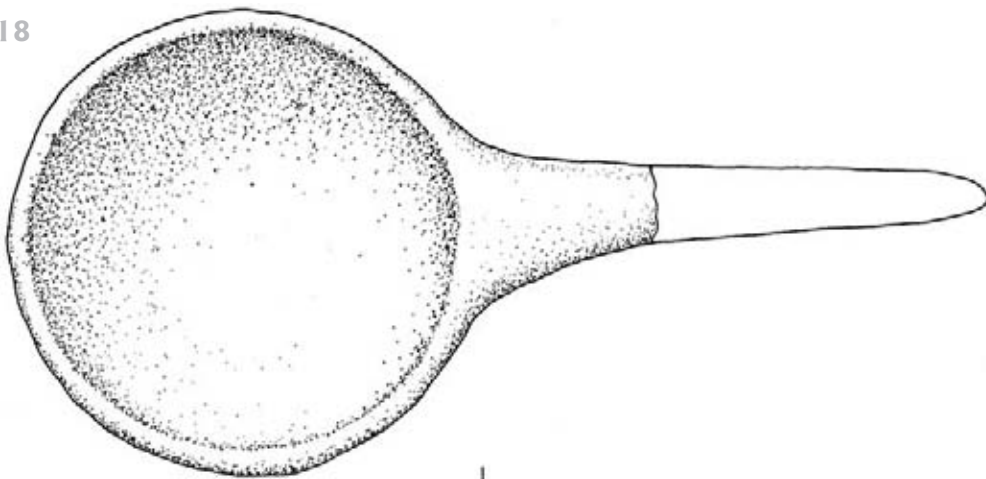

219



Tabla 57

220



221

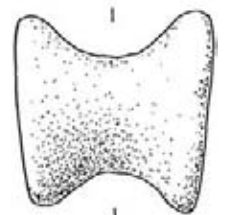
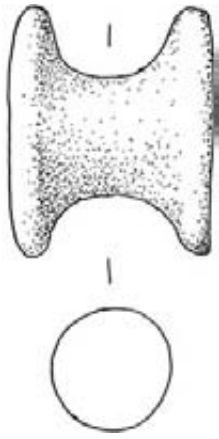
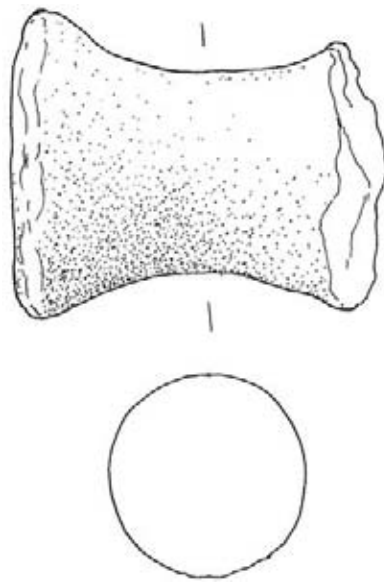

222

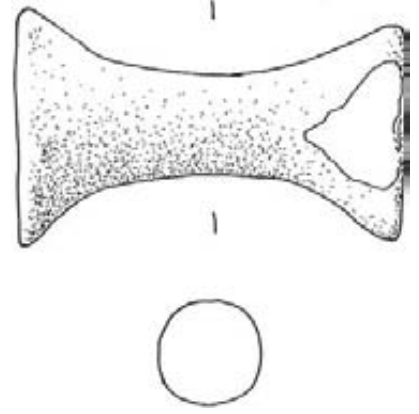

223

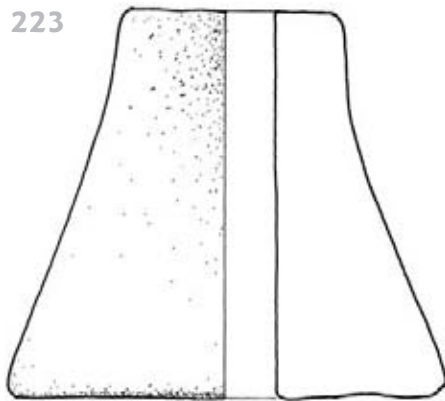

224



225



Tabla 58

226



227

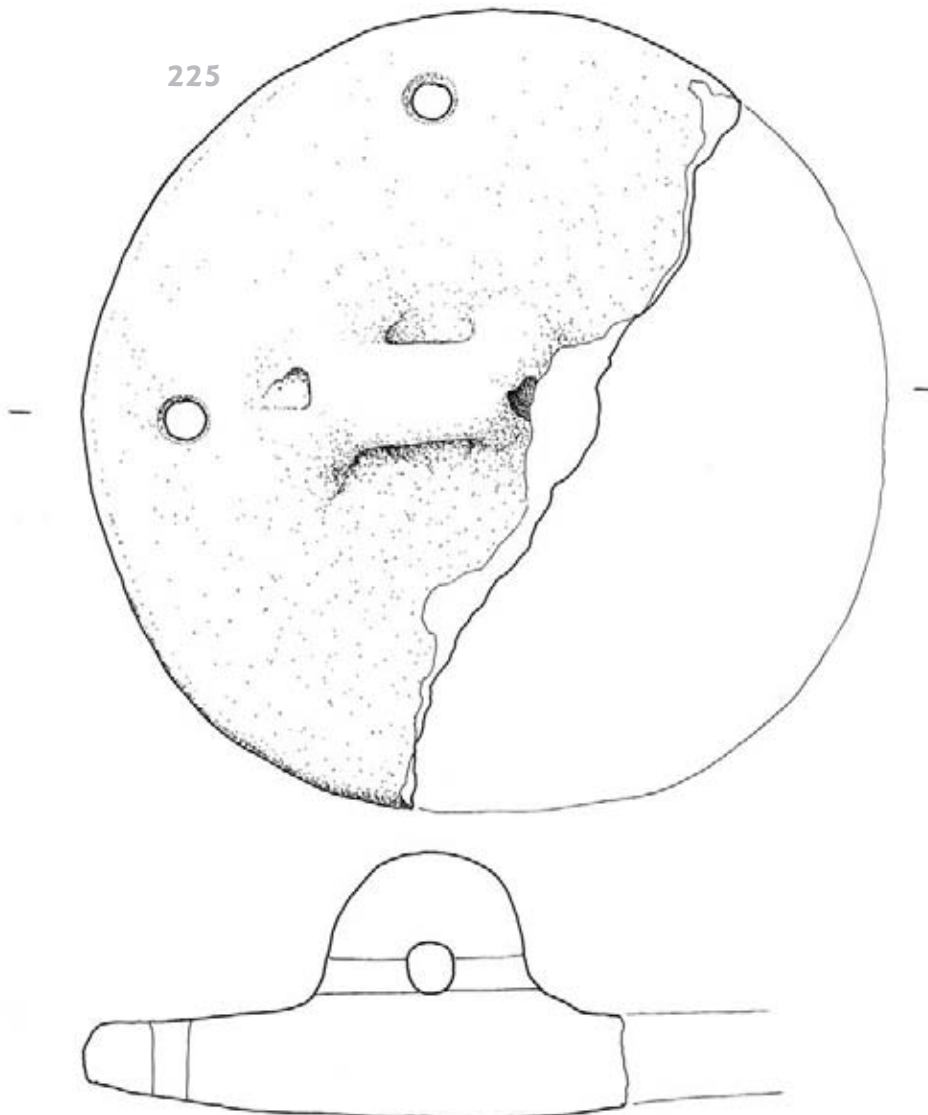
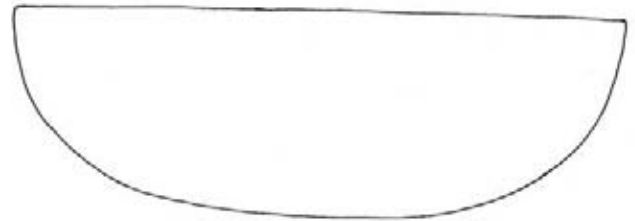
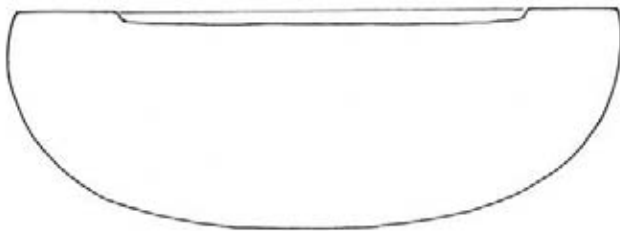
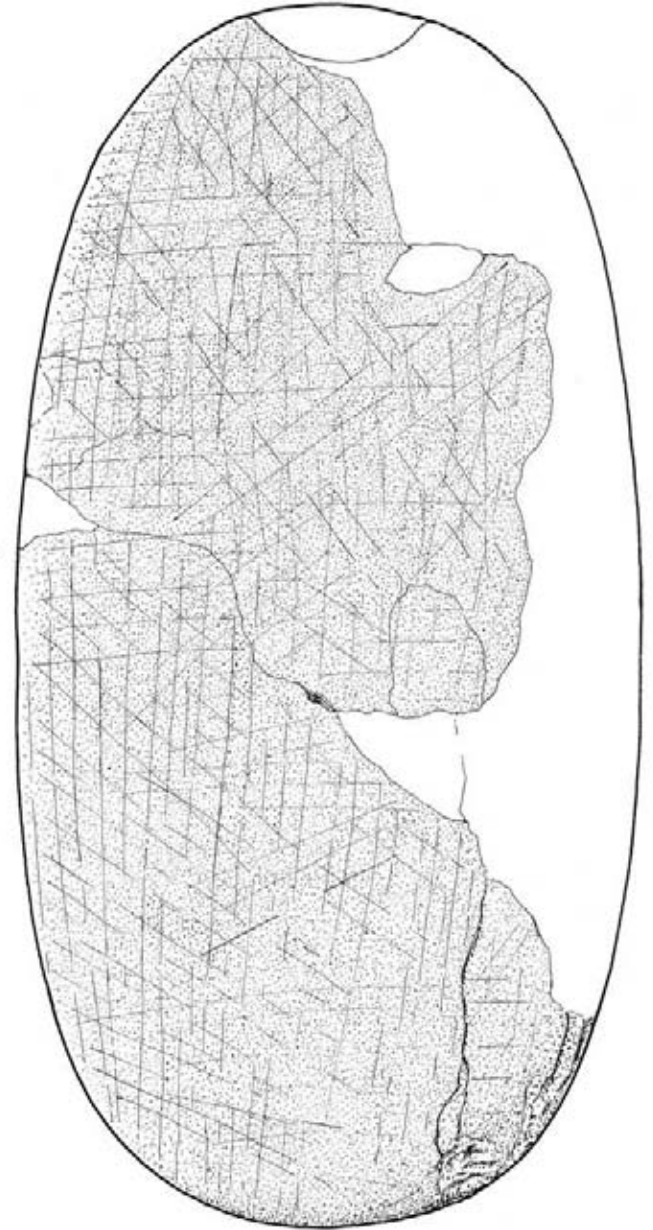
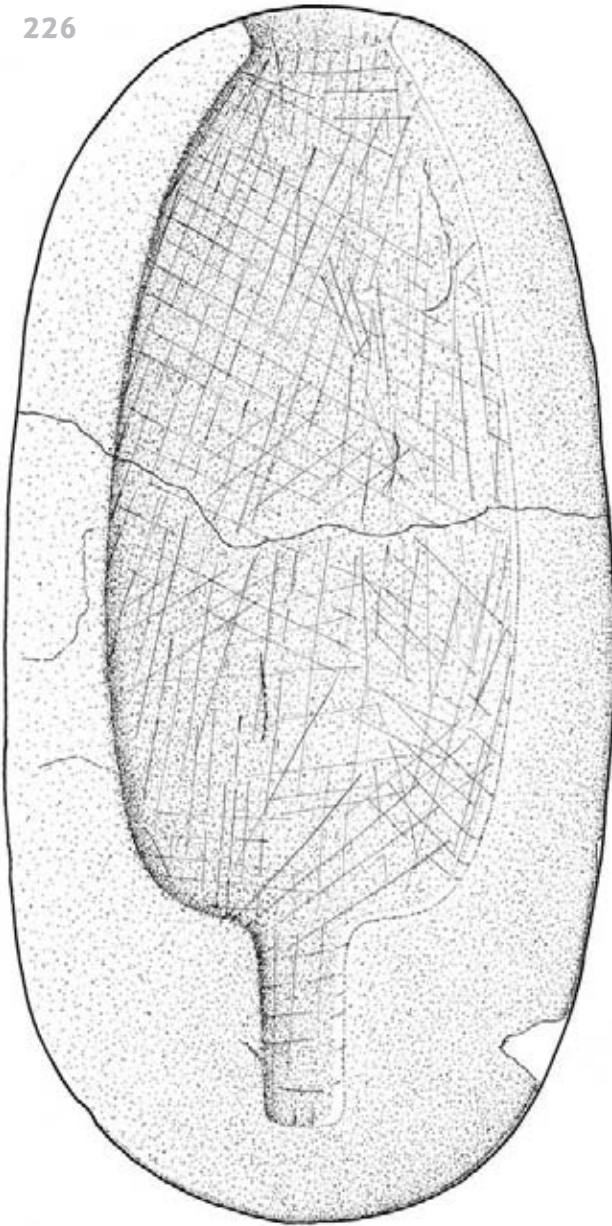

Tabla 60

228



229

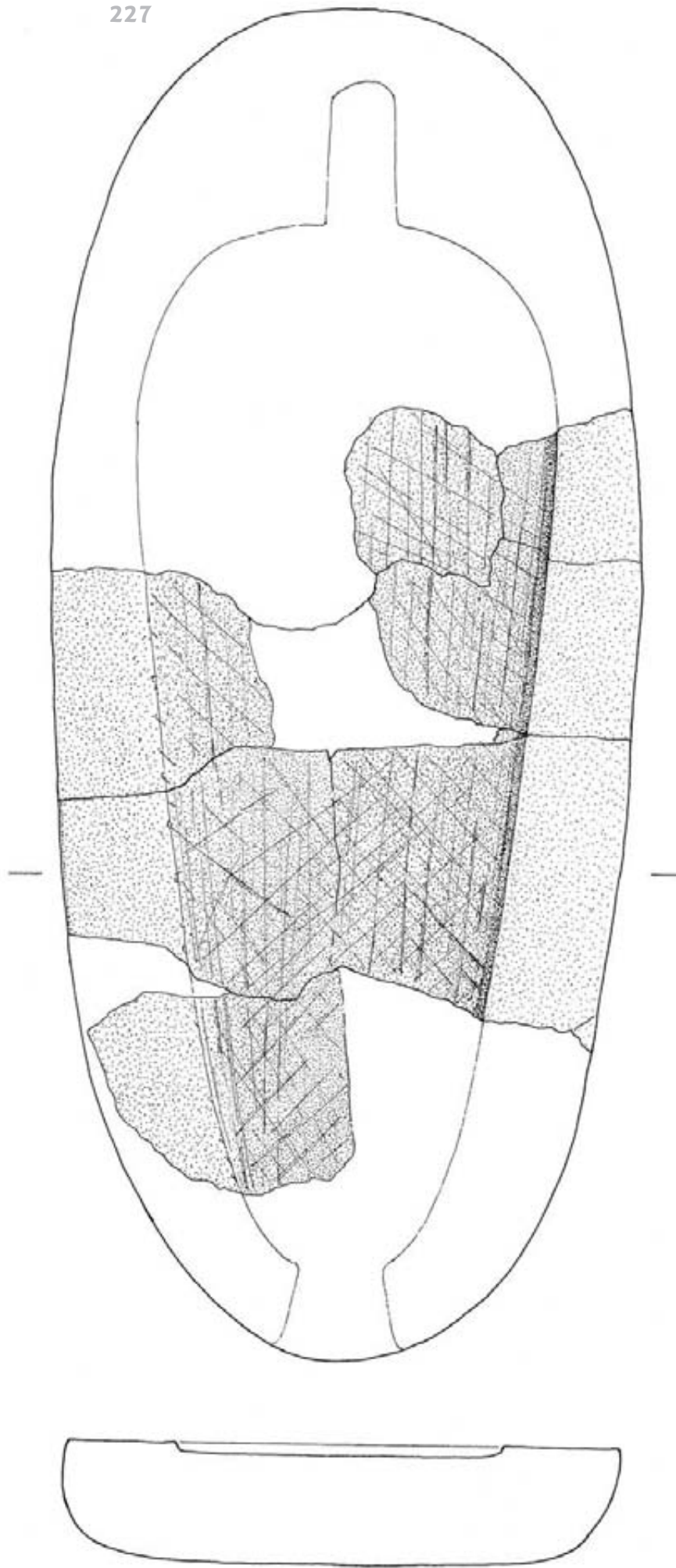
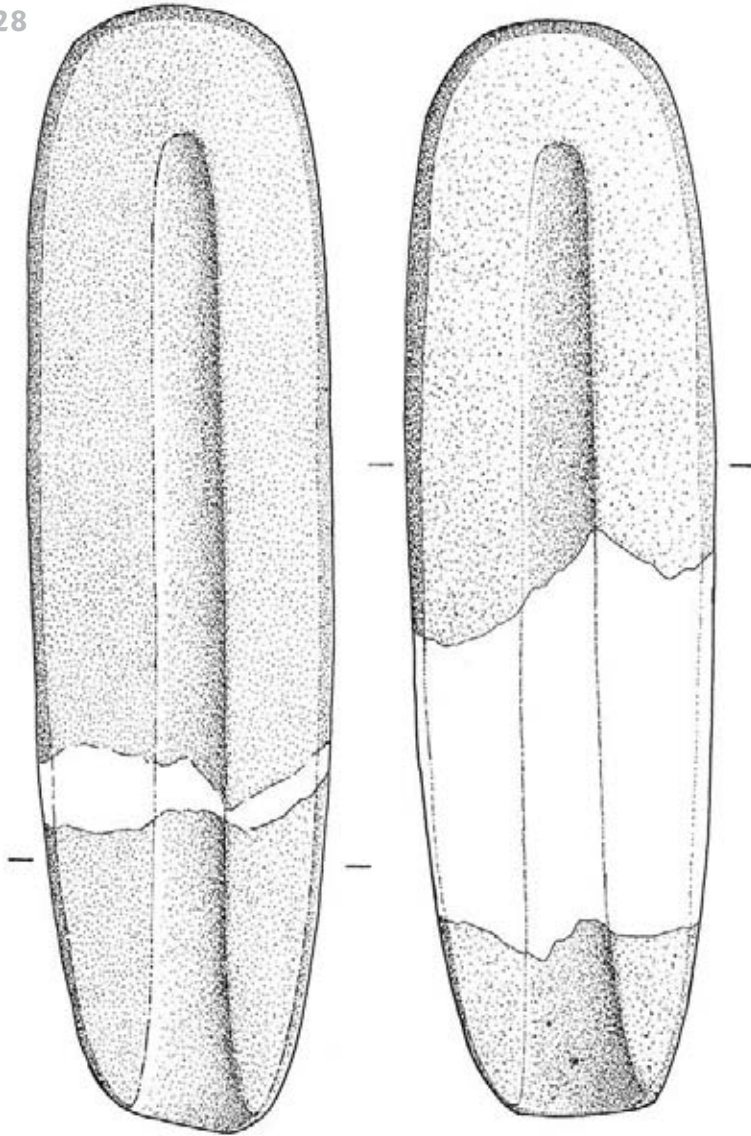
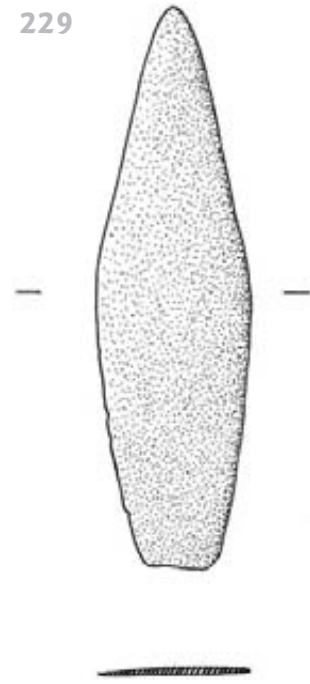

156



Tabla 61

230



231

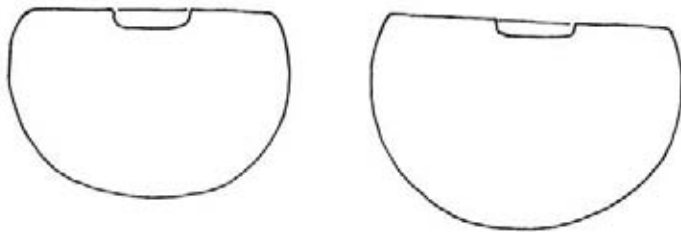
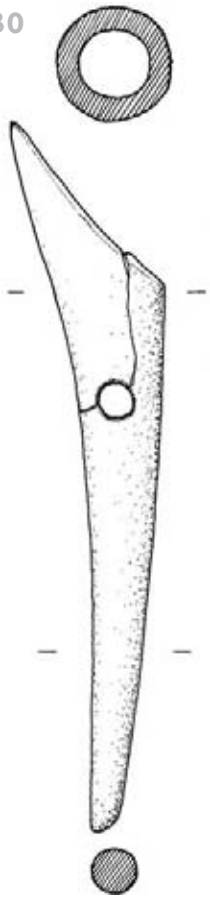
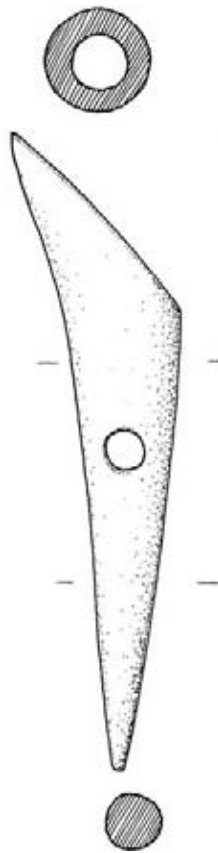

232

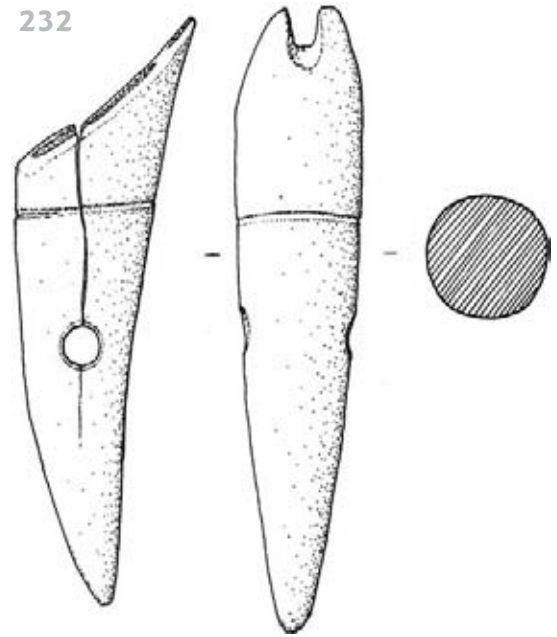

233

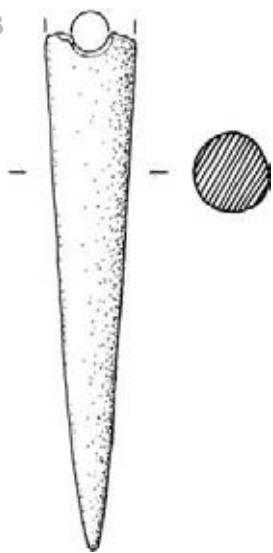

234

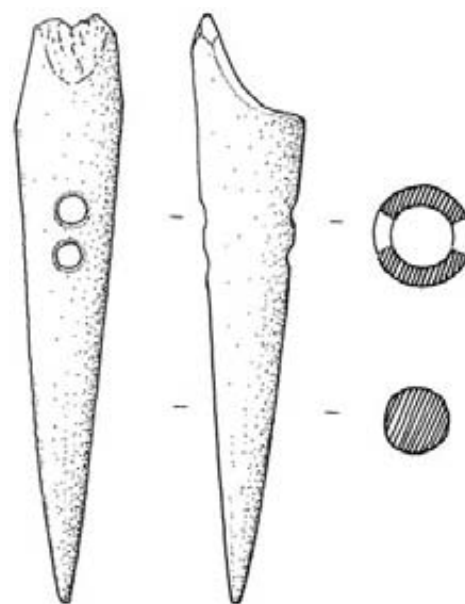

235



Tabla 62

236

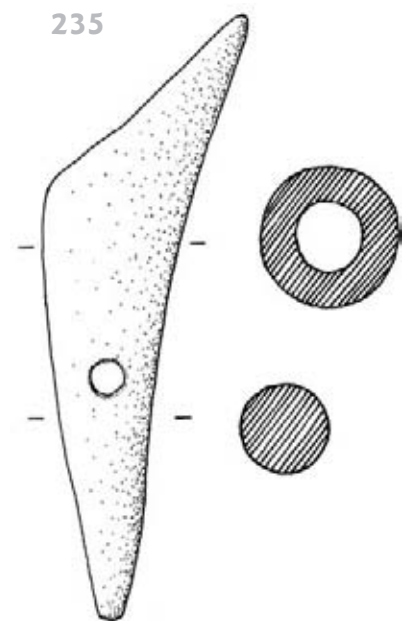
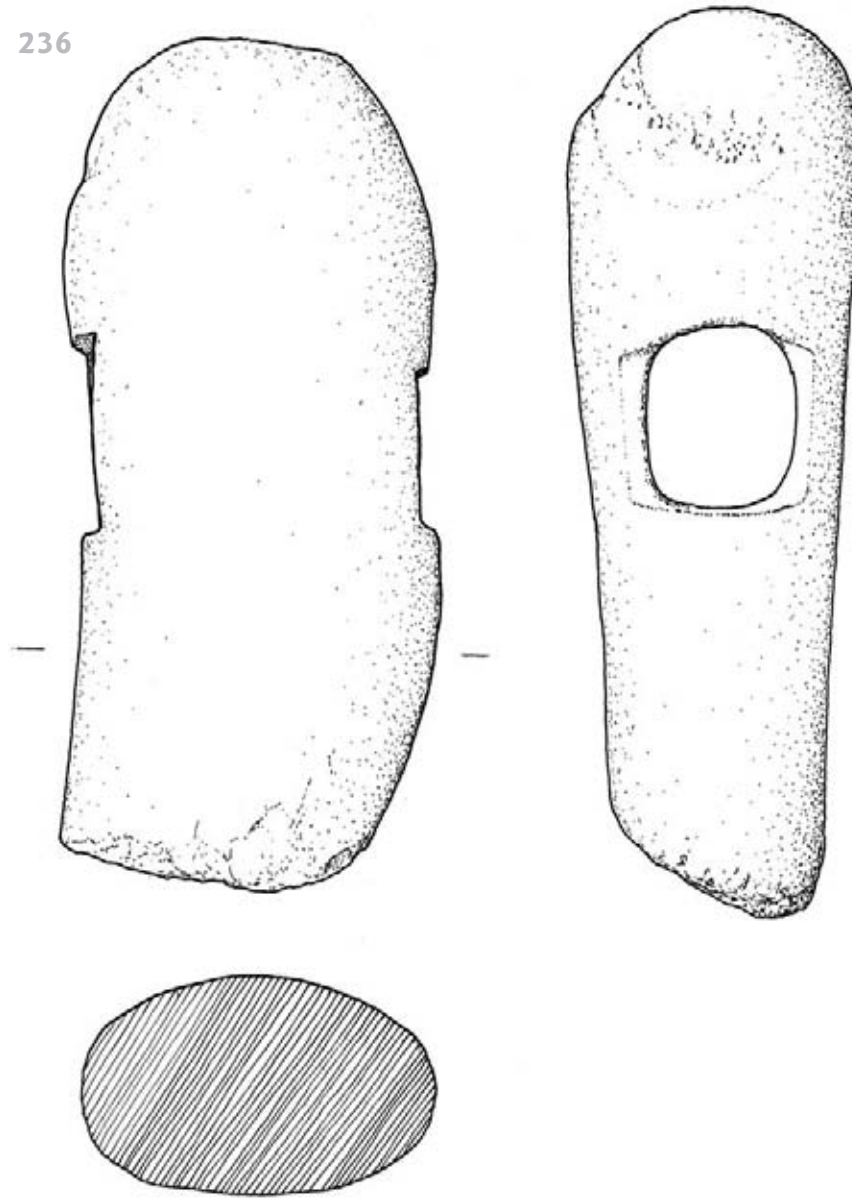

158

237



Tabla 63

238



240

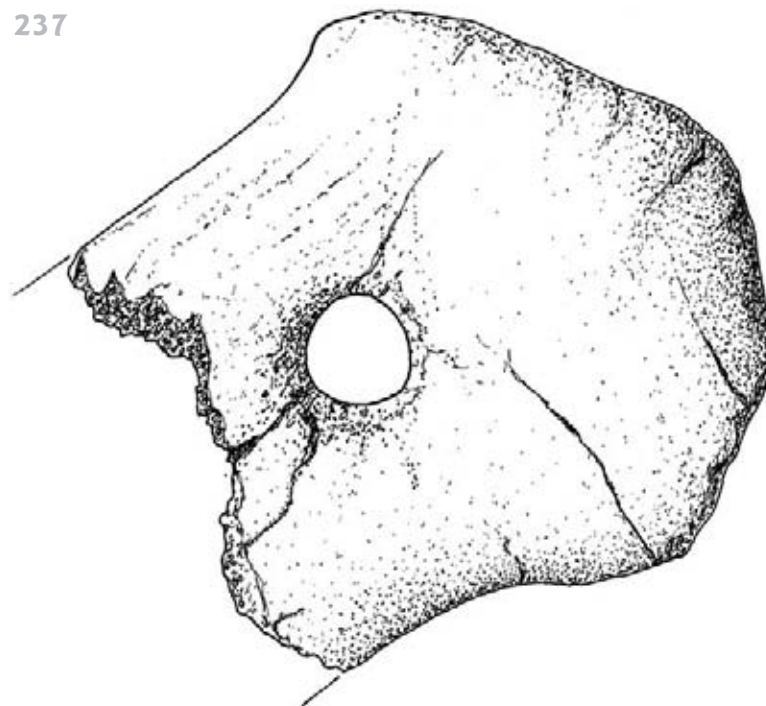
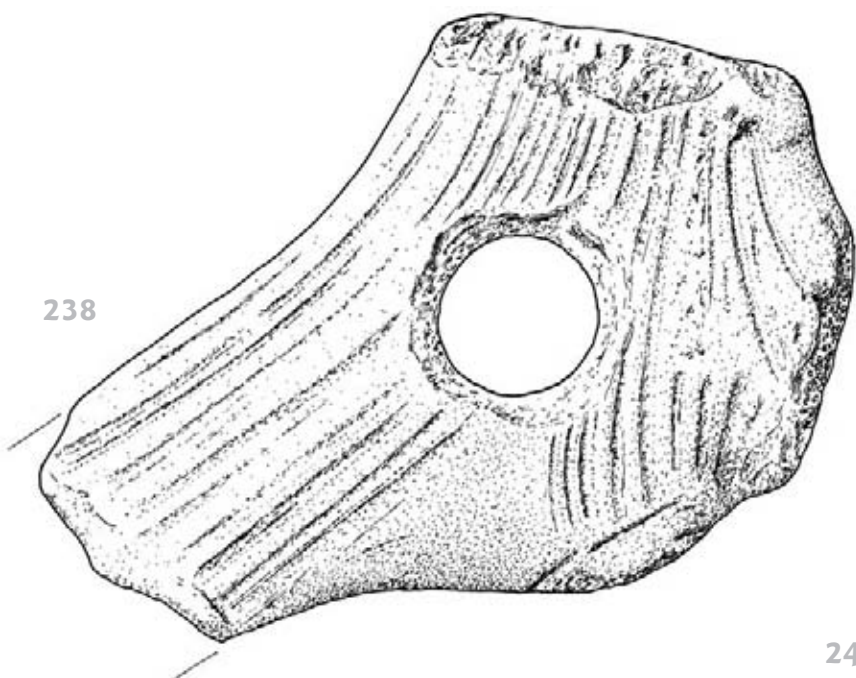
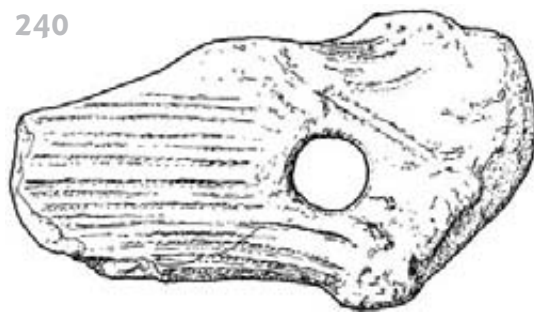

241

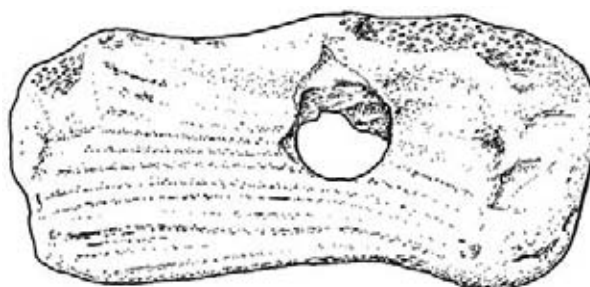

239

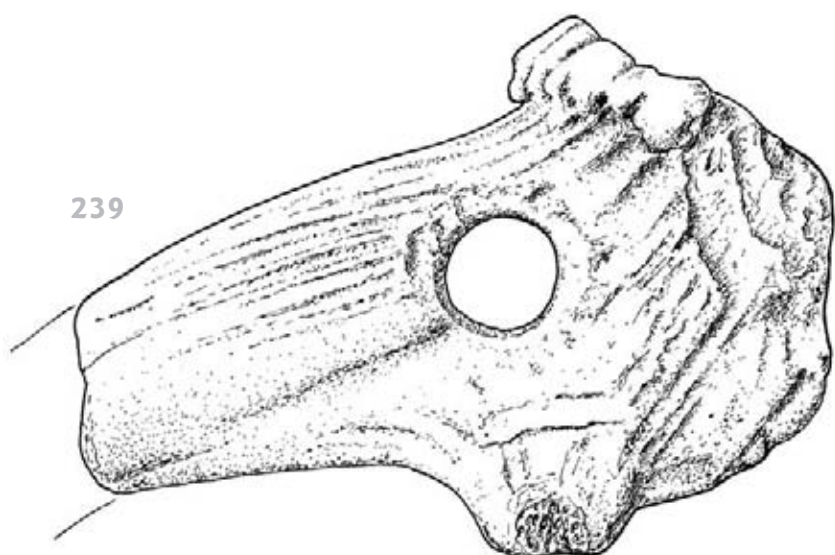

242

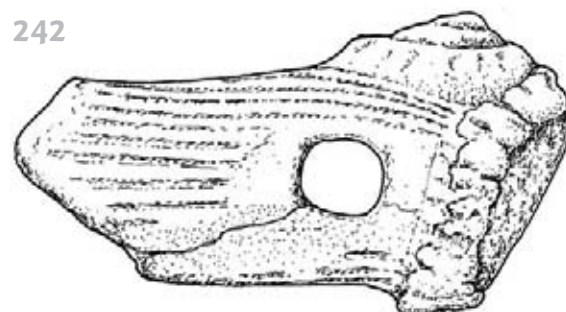

243

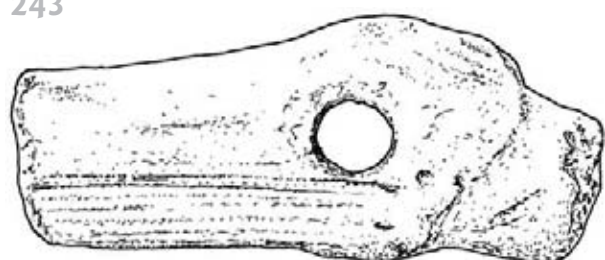

244



Tabla 64



245

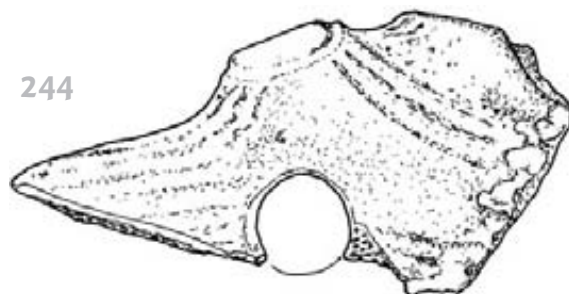
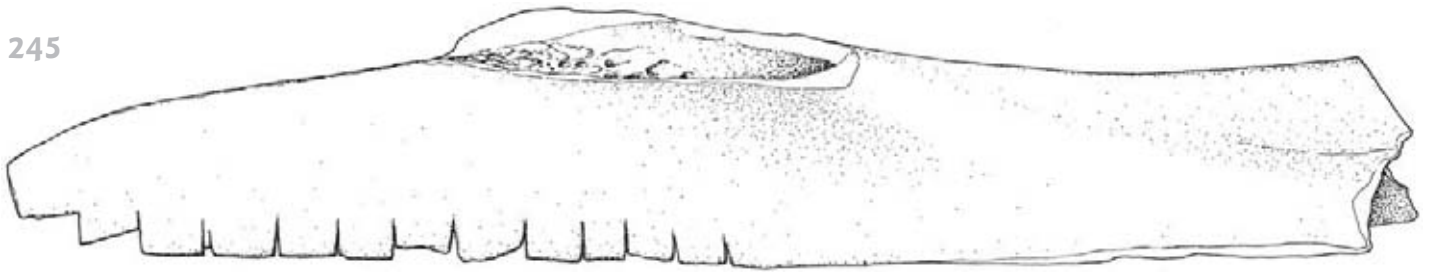

246

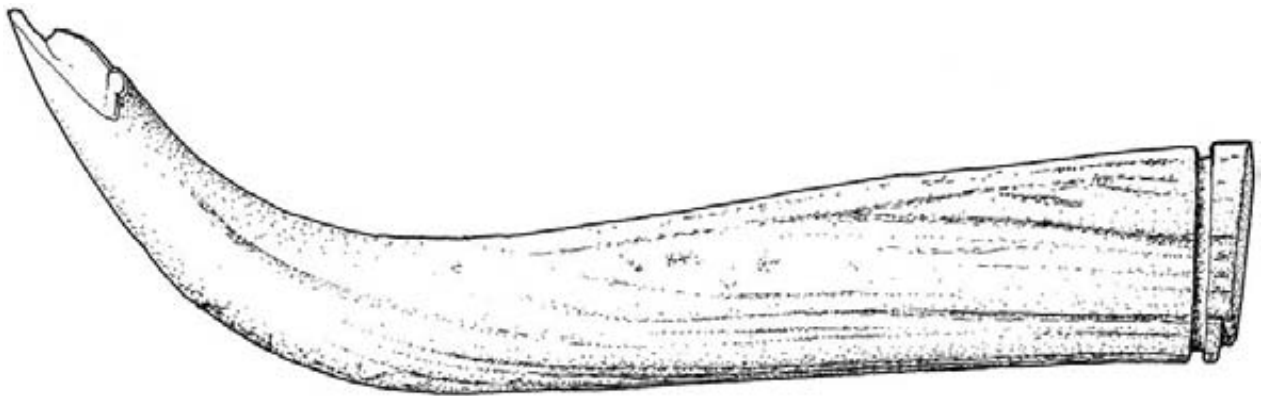

160

247

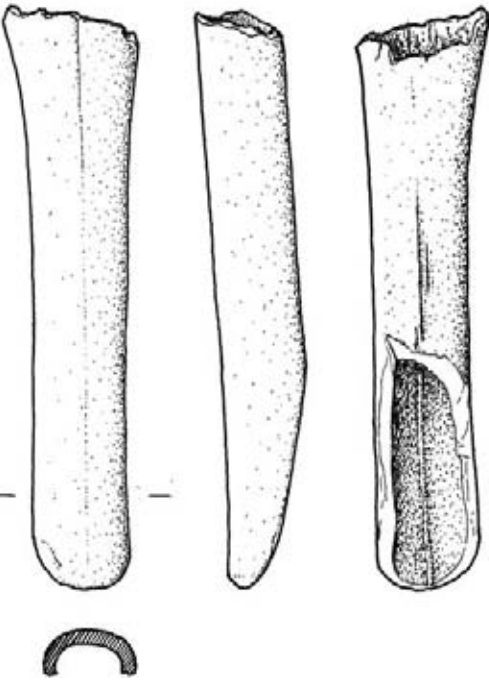

248

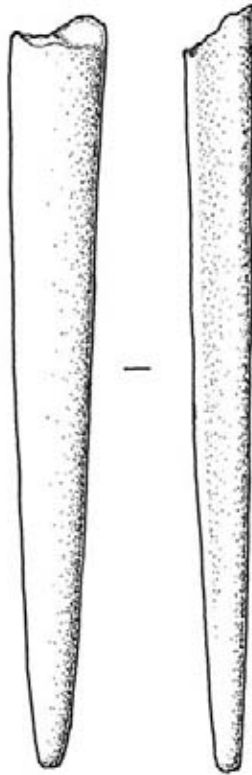

249



Tabla 65

250



251

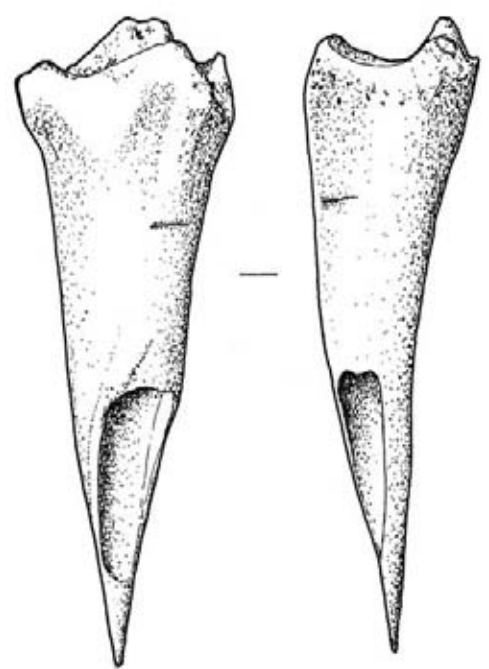
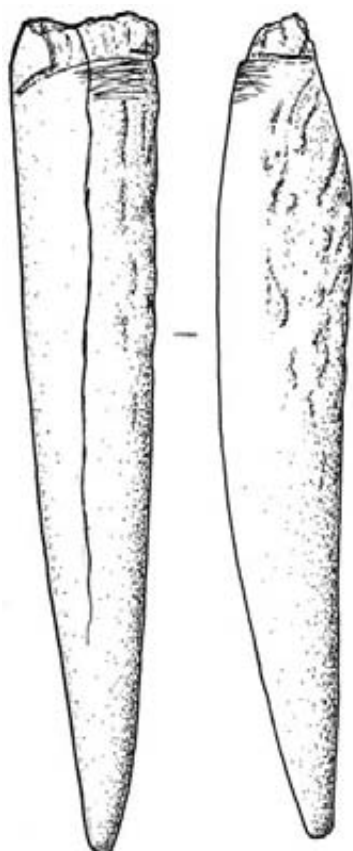

252

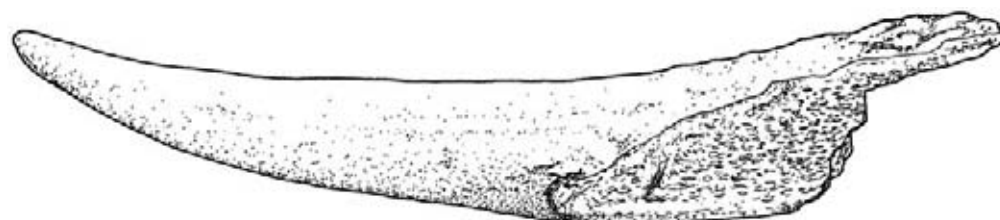

253

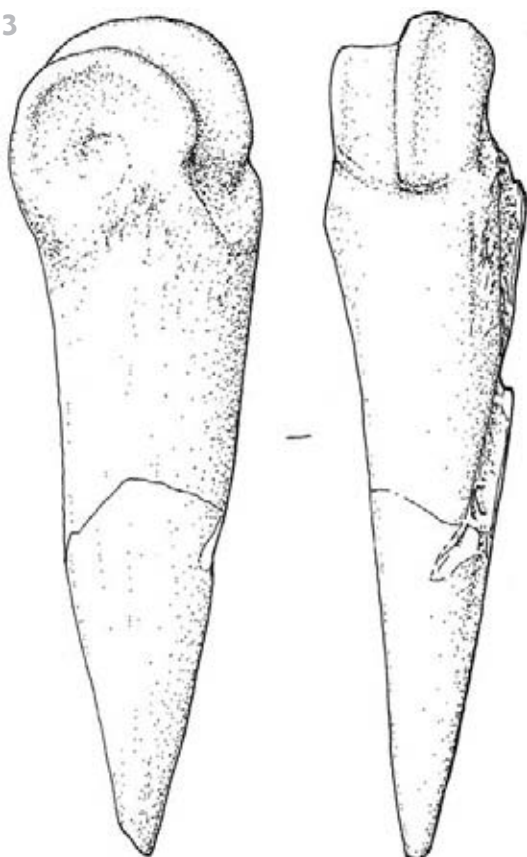

254



255

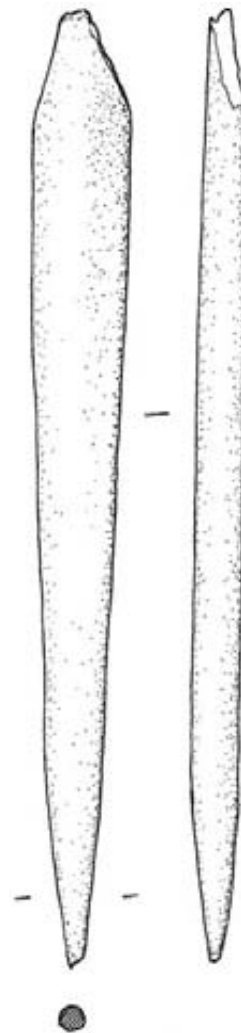

256

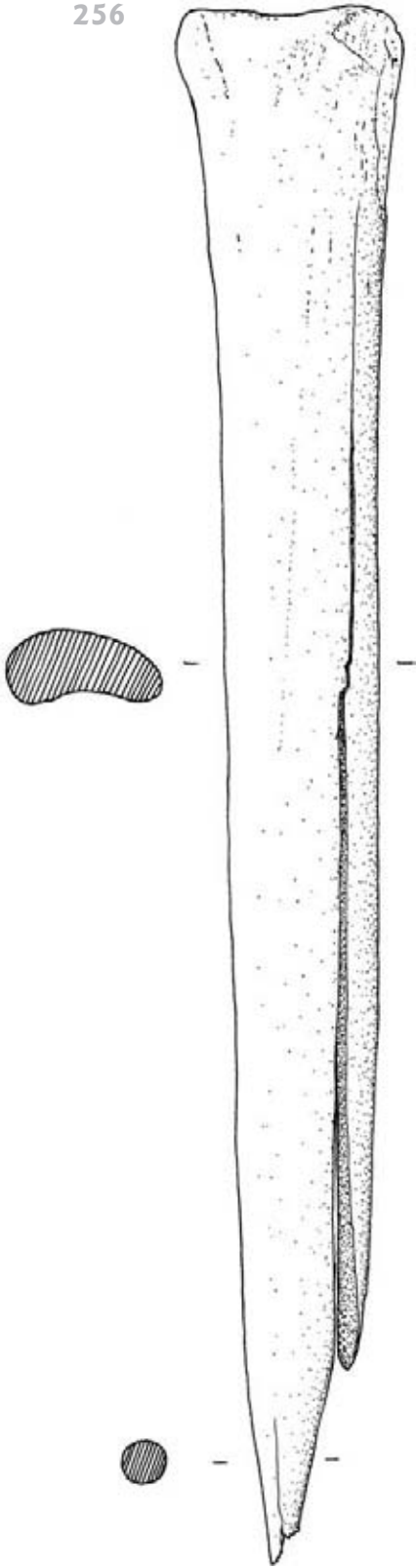

257

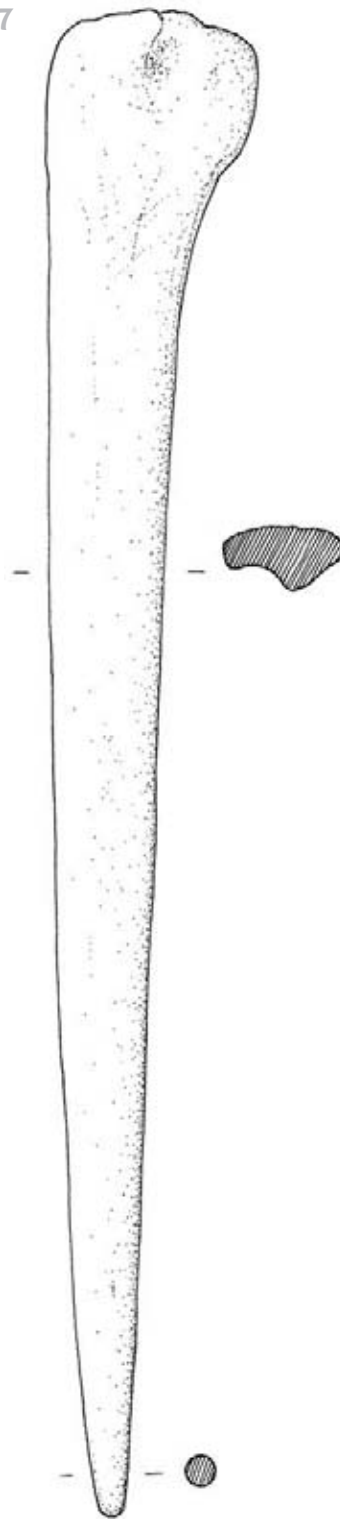

258

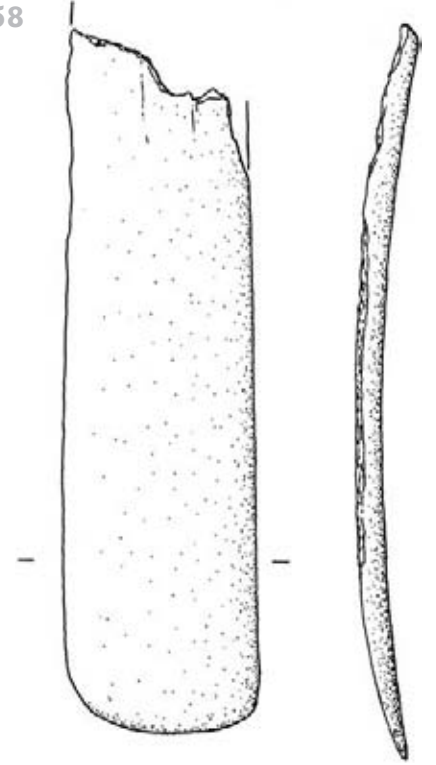

259

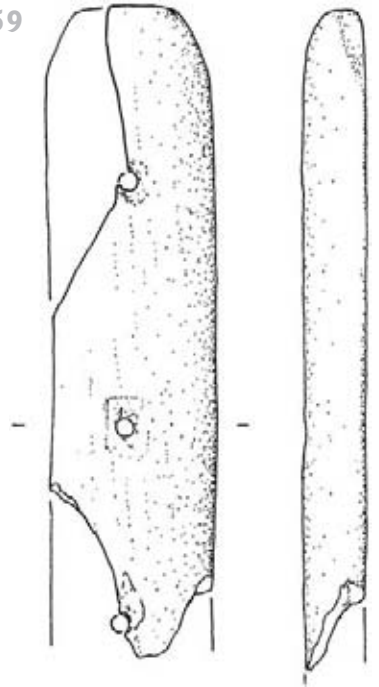

260

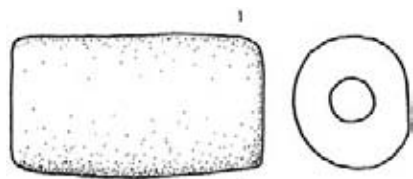

262

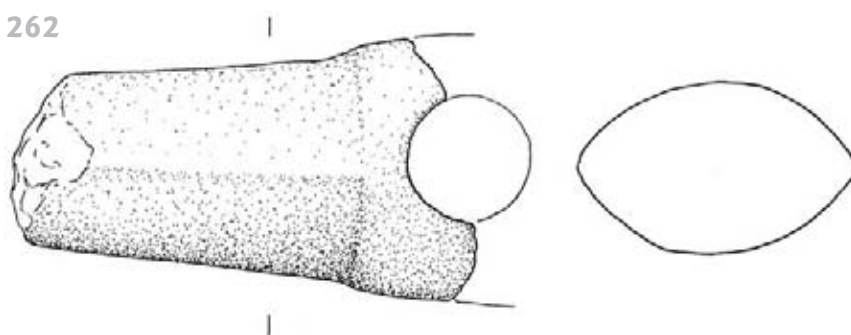

261

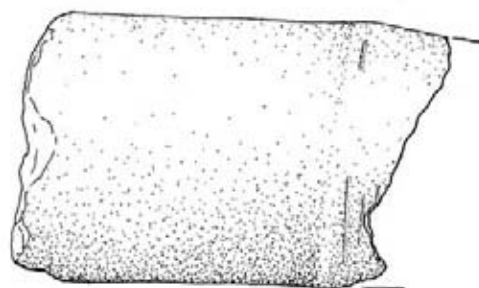
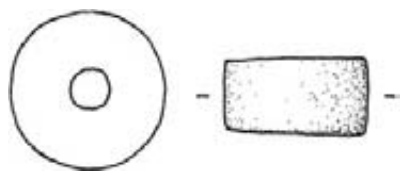

263

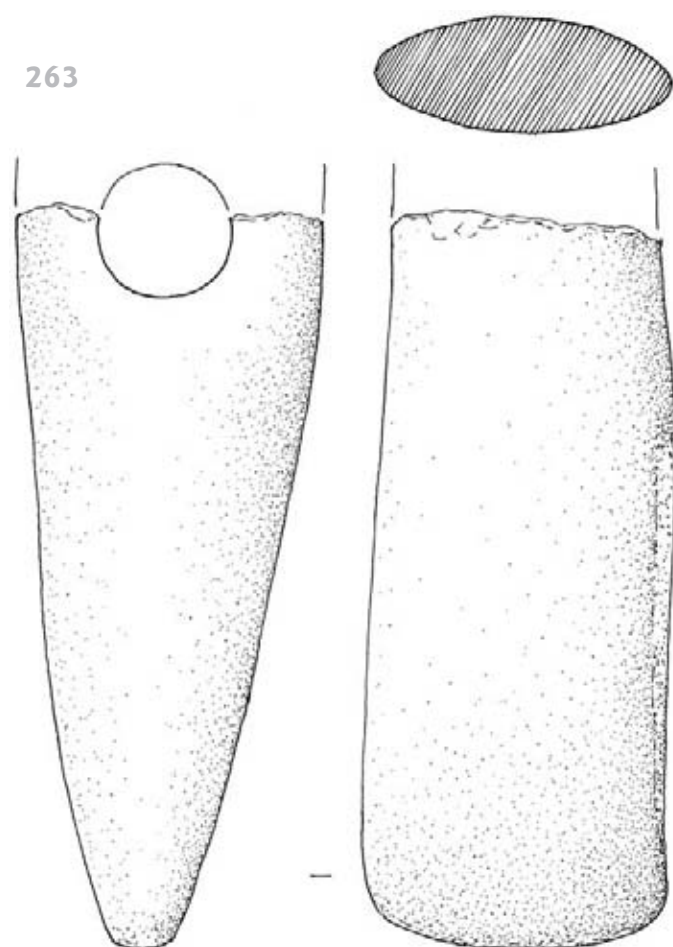

264



Tabla 68

265



266

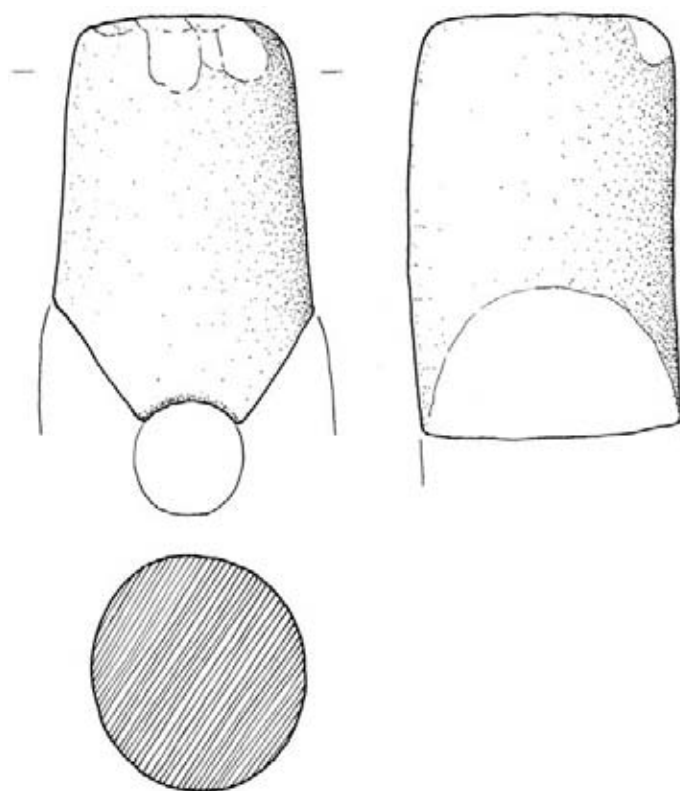
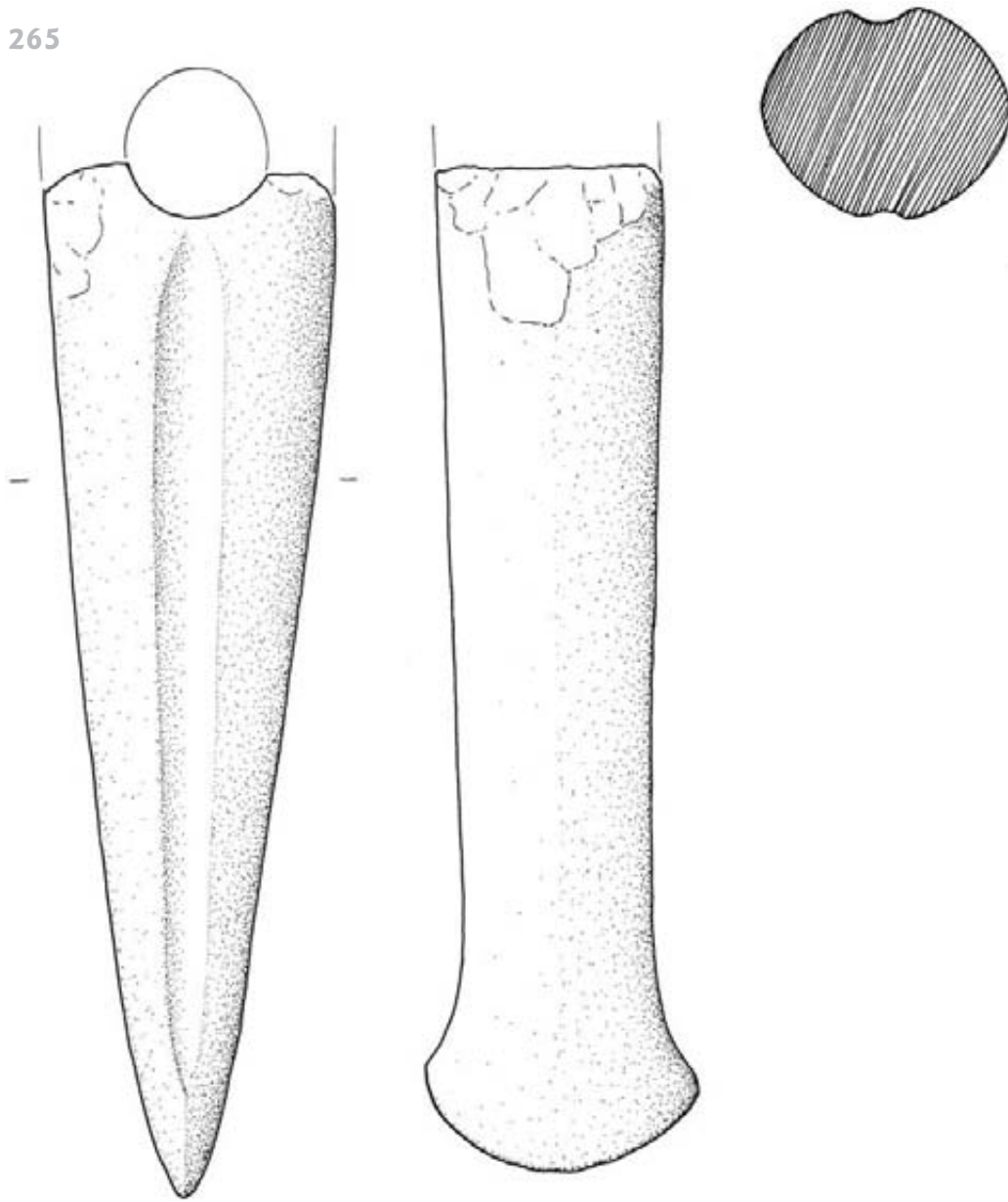

Tabla 69

267



268

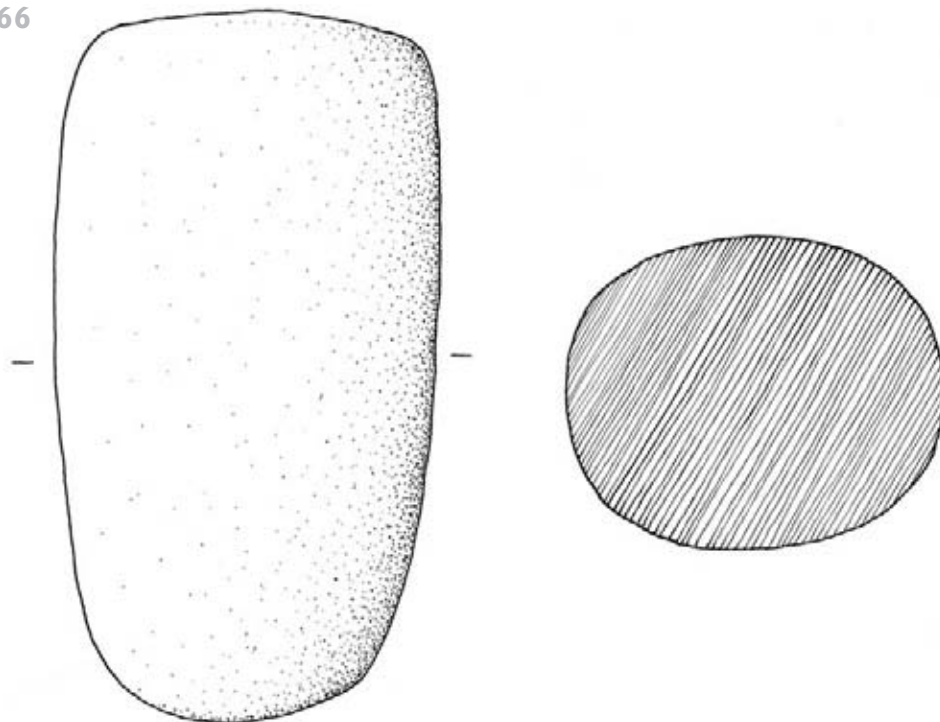
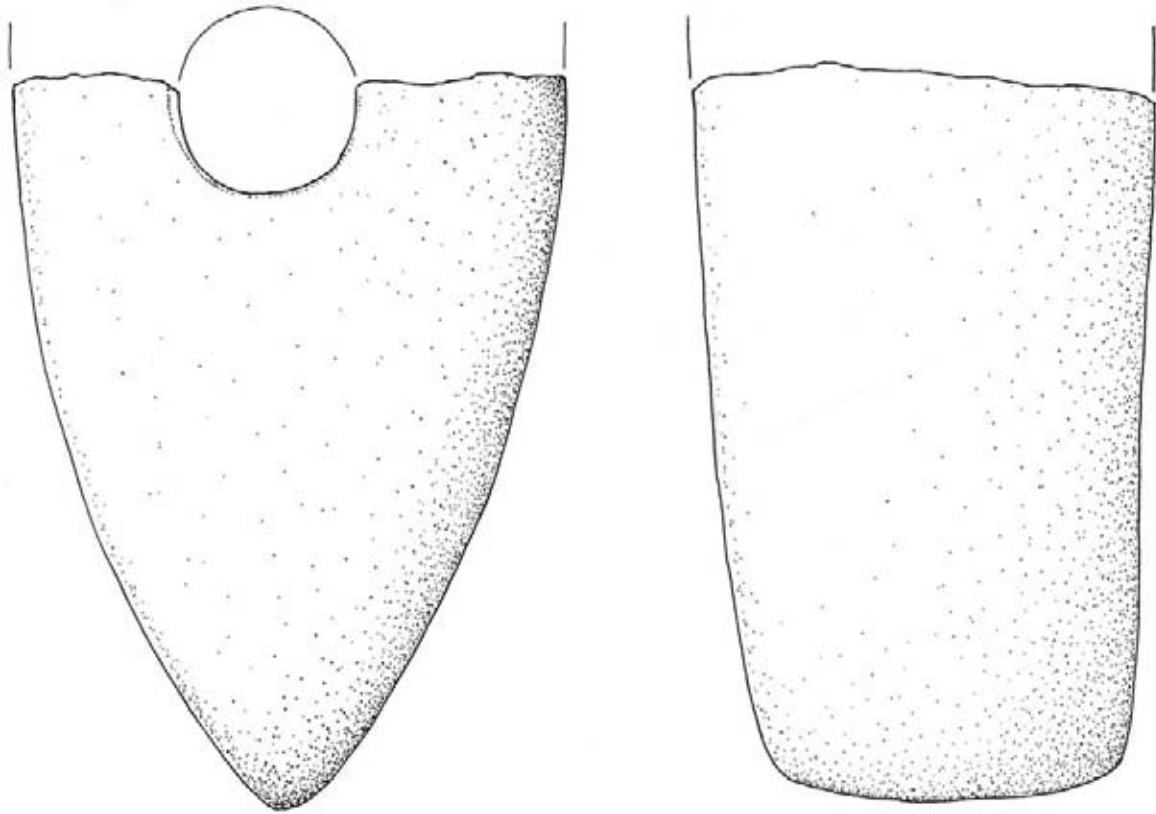
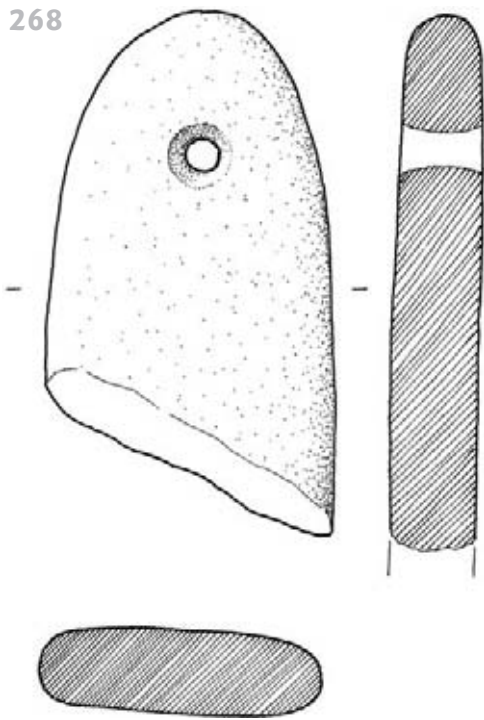

269

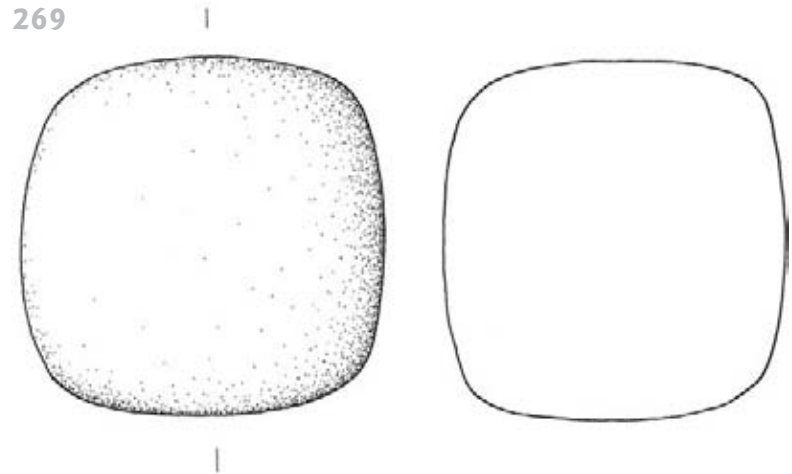

165

270



Tabla 70

271



275

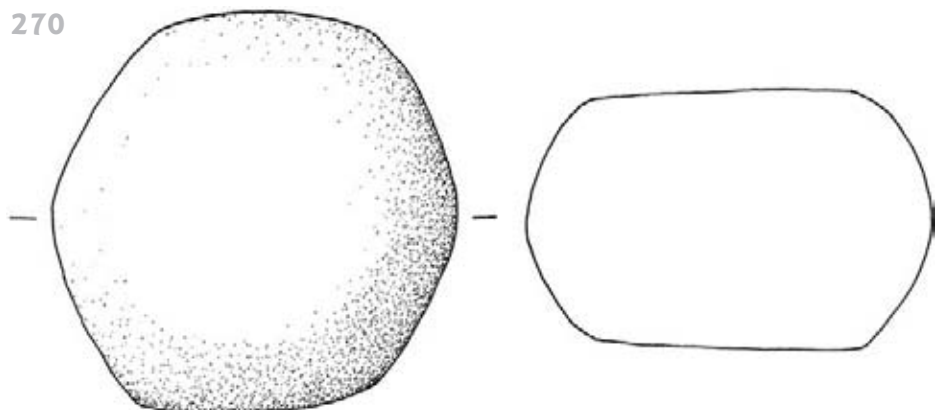
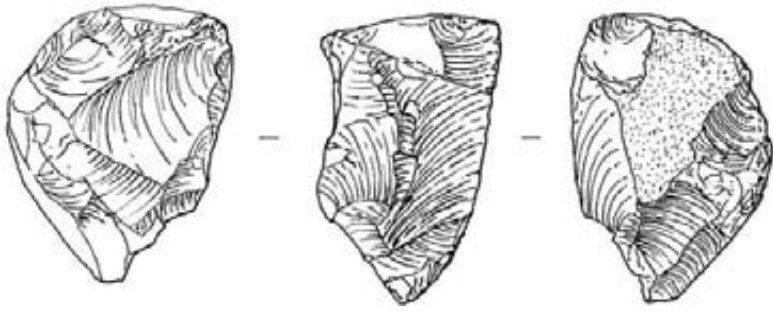
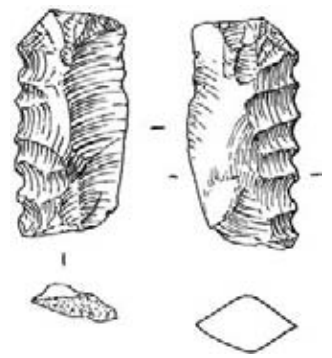

272

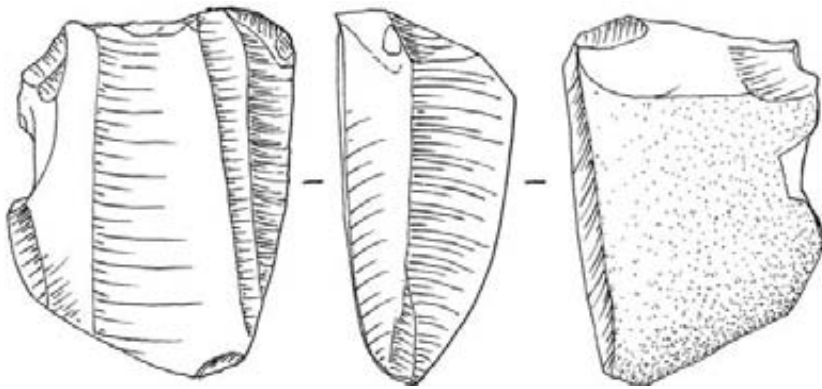

276

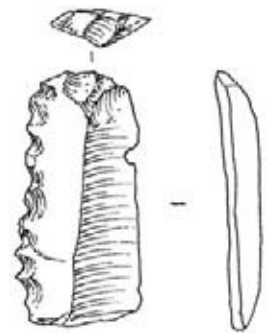

166

273

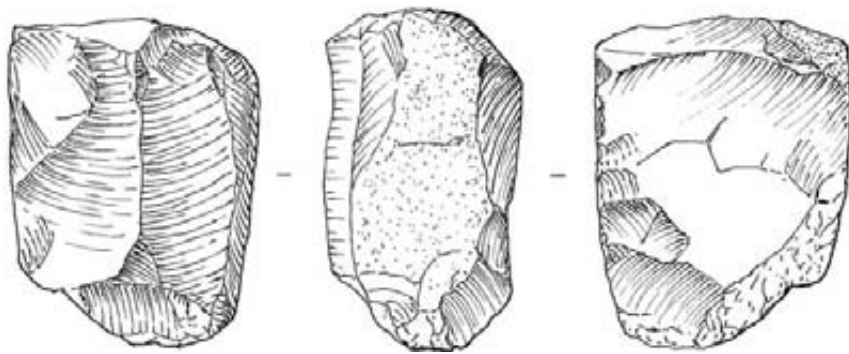

277

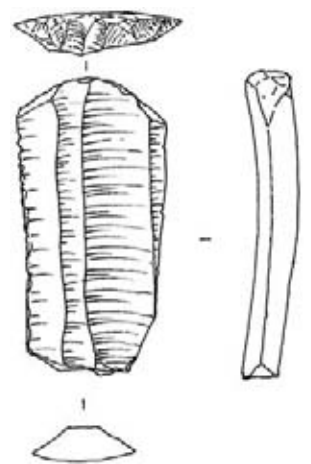

274

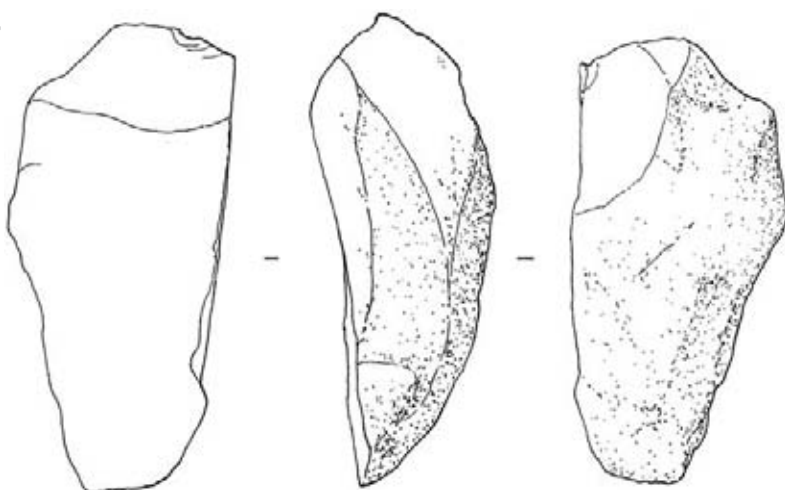

278



Tabla 71



Tabla 72

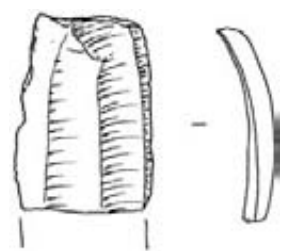

291

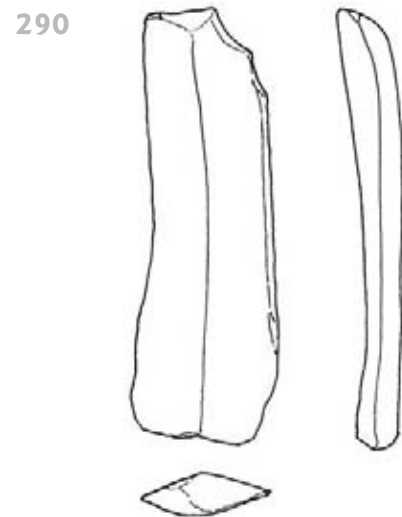
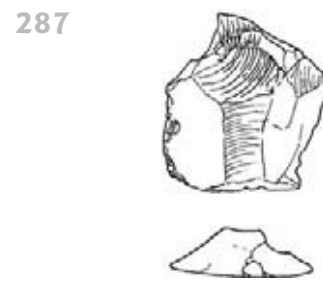
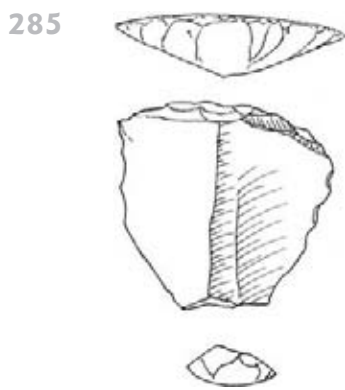
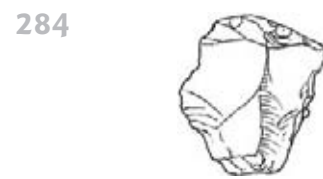
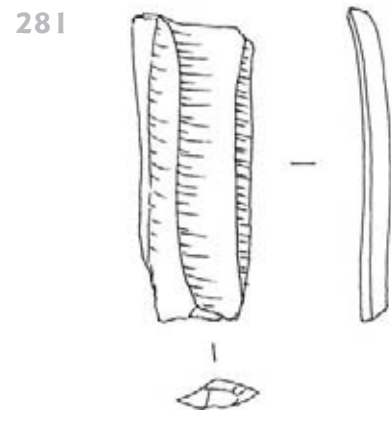
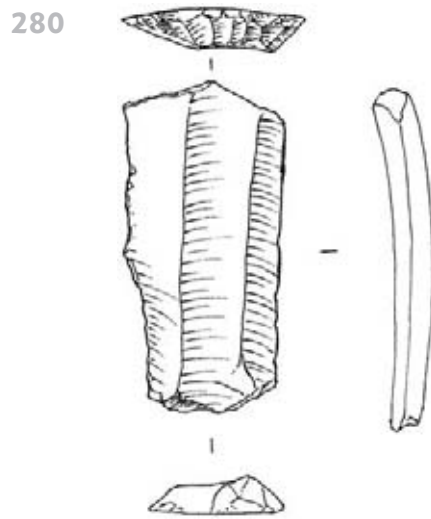
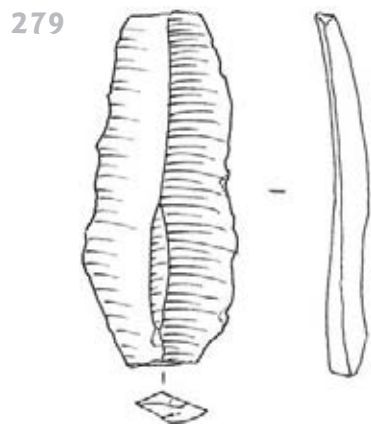
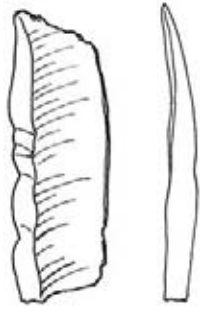

292

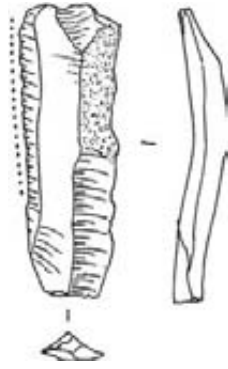

293

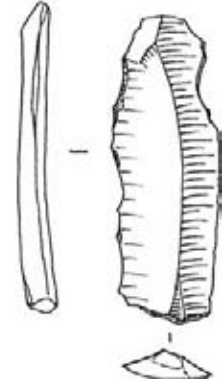

294

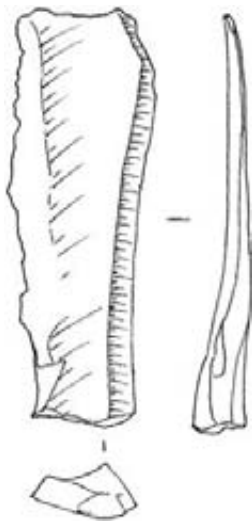

295

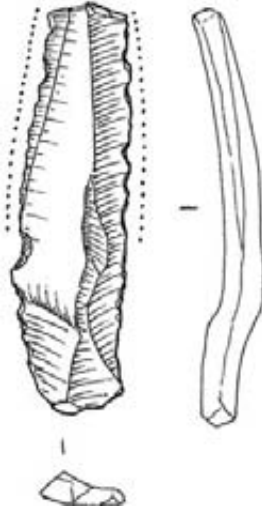

296

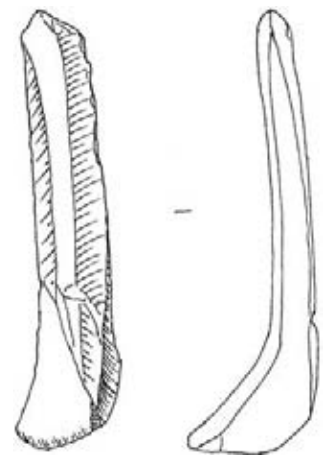

297

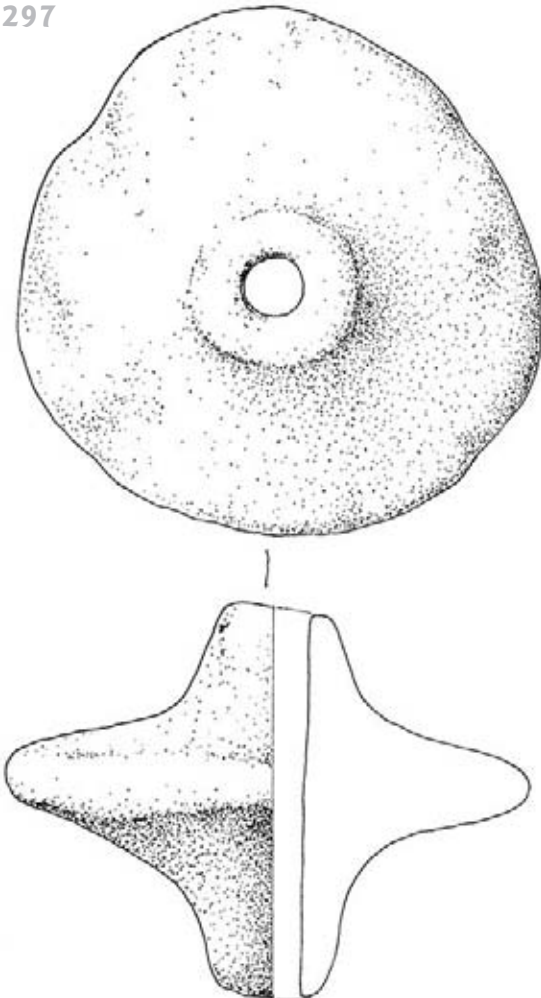

298



Tabla 73

299



300

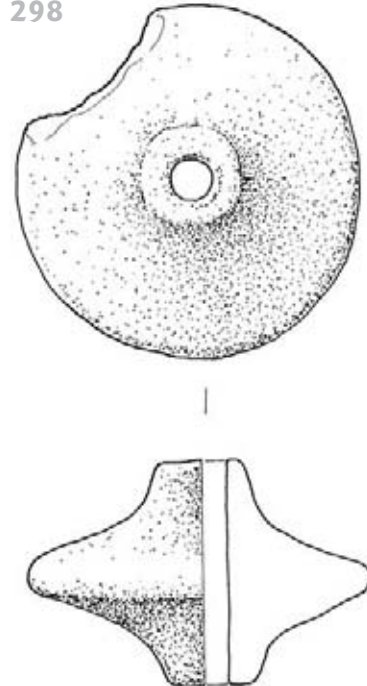
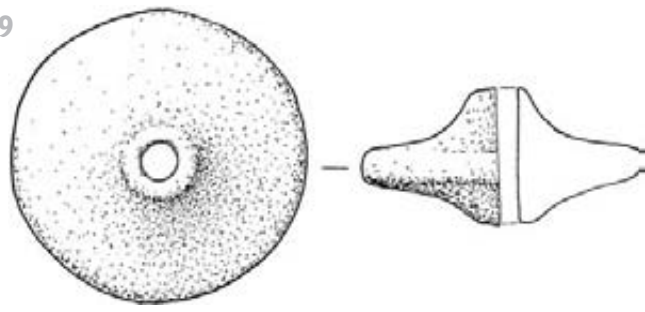
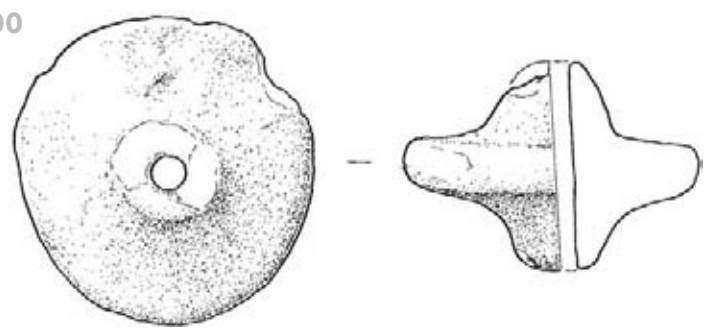

301

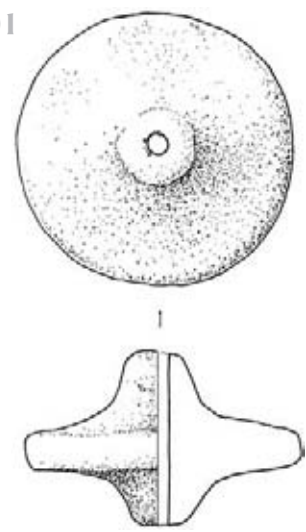

Tabla 74

